



10

603050

1979

Cabar

SAVAGE ARMS 1979

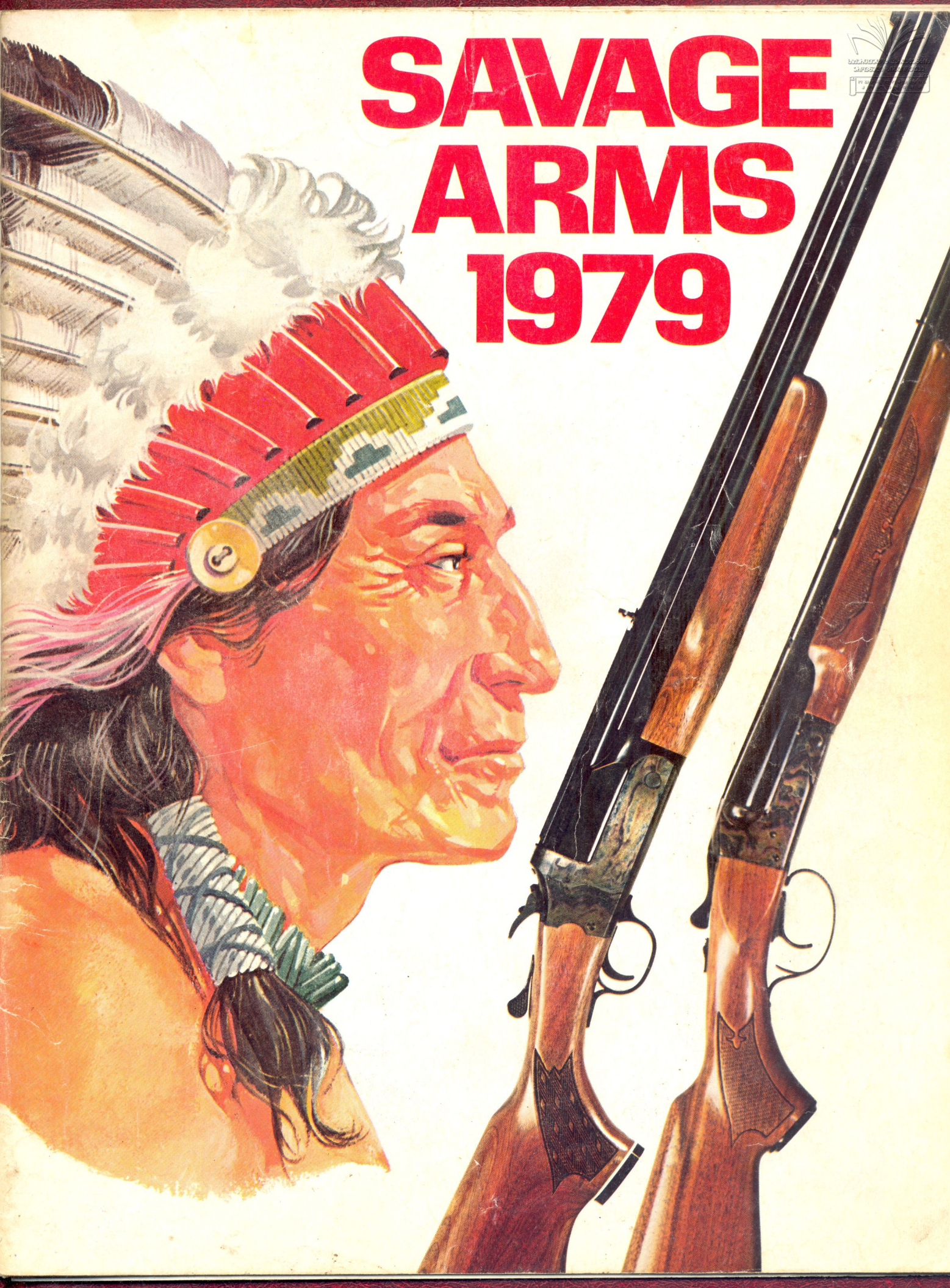

SAVAGE ARMS
CORPORATION
10000
10000
10000



Savage Shotgun and Combination Rifle/Shotguns

Model 242 Shotgun: 410 gauge over 410.

Why can't Savage make a 410 over-and-under? We can, and we do it. This little gun sports a deluxe stock and fore-end of select walnut. Has two-way top opening lever, swings either way for right-or left-hand use. Ideal for pest control or small game hunting. Also, makes an ideal shotgun for the beginner as well as the experienced shooter.

Model 24-D Deluxe Combinations: 22 long rifle/20 or 410 gauge; 22 Mag./20 gauge.

The separated barrels on this handsome deluxe model means lighter weight and better balance. Two-way top opening lever swings either way for right-or left-hand use. This combination gun is ideal for small game, pests and varmints as well as plinking. A 20 gauge slug can be used for larger game; the 22 magnum adds extra power and range for bobcat, fox, turkey.

Model 24 Field Grade Combinations: 22 long rifle/20 or 410 gauge; 22 Mag./20 gauge.

A combination gun at a field grade price makes this model an ideal first gun - combines the ever popular 22 cartridge with either of two popular shotgun gauges.

Model 24-C Campers Companion Combination: 22 long rifle/20 gauge.

At 5¾ pounds, it's a pound lighter and four inches shorter than other 24's. When stored in special case, it measures just 5" x 22". The case has handles for carrying, thongs for tying to pack or saddle. Trap door butt plate flips out for quick access to a shotgun shell and ten 22 cartridges (case included).





FEATURES

MODELS		242	24-D	24-FG	24-C
GROOVED FOR SCOPE			•	•	•
TOP LEVER OPENING		•	•	•	•
BARREL SELECTOR ON HAMMER		•	•	•	•
STOCK	SELECT WALNUT	•	•		
	WAL. FIN. HARDWOOD			•	•
SIGHTS	FRONT: RAMP	BEAD	•	•	•
	REAR: SPORTING		•	•	•
	REAR FOLDING LEAF		•		

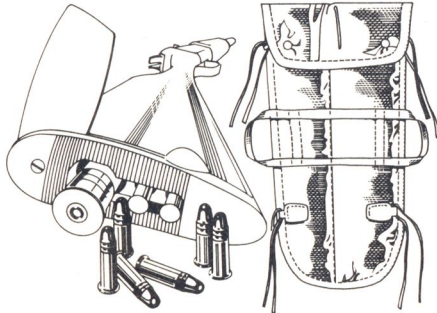

SPECIFICATIONS: BARREL-CHOKE-CHAMBER

MODEL		242	24-D		24-FG		24-C		
CALIBER & GAUGE		410 ONLY	22 L.R. 20	22 L.R. 410	22 MAG 20	22 L.R. 20	22 L.R. 410	22 MAG 20	22 L.R. 20
BARREL LENGTHS & CHOKES	24" FULL	•	•	•	•	•	•	•	•
	20" CYL.								•
CHAMBERED FOR		2 1/2" & 3"	2 3/4" & 3"	2 1/2" & 3"	2 3/4" & 3"	2 3/4" & 3"	2 1/2" & 3"	2 3/4" & 3"	2 3/4" & 3"
LENGTH	OVERALL	40"	40"		40"		36 1/2"		
	TAKEN DOWN	24"	24"		24"		20"		
	STOCK	14"	14"		14"		14"		
DROP AT	COMB	1 3/4"	2"		1 3/4"		1 3/4"		
	MONTE CARLO		1 3/4"						
	HEEL	2 3/4"	2 5/8"		2 3/4"		2 3/4"		
AVERAGE WEIGHT (LBS.)		7	7 1/2		6 1/2		5 3/4		
RATE OF TWIST (R.H.)		1 TURN IN 16" FOR 22 MAG. & 22 L.R.							

CYL. - Cylinder L.R. - Long Rifle MAG. - Magnum



242

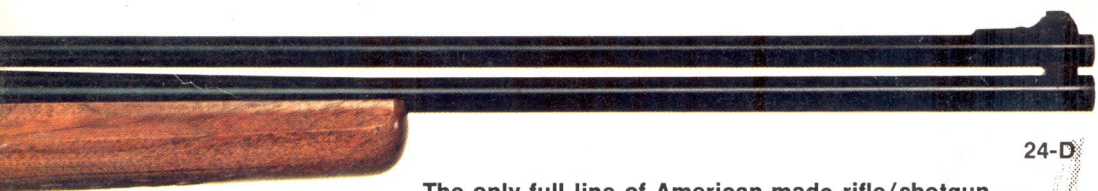

24-D

Note:

The only full line of American-made rifle/shotgun combinations.
 World's most versatile gun in a variety of popular calibers.
 Carried by nearly one million sportsmen.
 A proven survival gun.
 Takedown for easy storage.
 Chambered for 3" shells.



Savage Combination Rifle/Shotgun



Model 24-V Combinations: 30-30/20 gauge; 222/20 gauge, and **NEW 223/20 gauge.**

The 20 gauge takes regular and 3" magnum shells, perfect for all small game or pests. Use a 20 gauge slug and you are set for larger game. Choose the 30-30 version for deer and other medium size game; the 222 version and 223 version for turkey, small game, and varmints.

New Model 24-V Companion Rifle/Shotgun Combination: .357 Magnum (38 Special) over 20 gauge

This unique combination firearm adds greater versatility for the hunter, camper or backpacker who carries a handgun of the same caliber during outdoor activities.

SPECIFICATIONS: BARREL-CHOKE-CHAMBER

MODEL		24-V		
CALIBER & GAUGE		222 or 223 20	30-30 20	.357 Mag. (.38 Spec.) 20
BARREL LENGTH & CHOKE—24" FULL		•	•	•
CHAMBERED FOR		2¾" & 3"		
LENGTH	OVERALL	40"		
	TAKE DOWN	24"		
	STOCK	14"		
	COMB	2"		
DROP AT	MONTE CARLO	1¾"		
	HEEL	2⅝"		
AVERAGE WEIGHT (LBS.)		6¾ - 7½		
RATE OF TWIST (R.H.)		1 TURN IN 12" FOR 30-30 & .357 Mag.		
		1 TURN IN 14" FOR 222, 223		

FEATURES

MODEL	24-V	
SCOPE MOUNTING	TAPPED	•
TOP LEVER OPENING		•
BARREL SELECTOR	ON HAMMER	•
STOCK	SELECT WALNUT	•
SIGHTS	FRONT: BLADE .357 CAL.	•
	FRONT: RAMP (OTHER CALIBERS)	•
	REAR: FOLDING LEAF	•

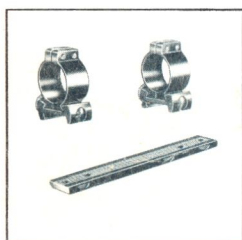

Rings and B-5 base, set. B-5 is a special one-piece base for 24-V.



24-V

Mounts and scope not included



Featherweight Model
Only Weighs About 5 oz.

Re-Introducing The Savage Four - Tenner Shotgun Gauge Adapter



Pat. No. 3,339,304
Pat. No. 3,156,995



IDEAL FOR SIDE - BY - SIDE DOUBLES



FITS OVER - AND - UNDER GUNS

Model 412 in 2 sizes, fits 12 and 20 gauge shotguns. The Savage "Four-Tenner" converts most break-action shotguns — single barrel, side-by-side double, or over-and-under — to fire 410 gauge shells. Just slip the "Four-Tenner" into the breech of the gun like an extra long shell. Center the auxiliary extractor over the gun's own extractor. It will function as an extractor or an ejector, depending on the action of the gun. To return to the larger gauge, the adapter is easily removed. No alteration of gun is required. The featherweight "Four-Tenner" weighs only 5 ounces, and has a slim silhouette. Breech is proof-tested steel, barrel is aluminum. Only 12 inches long, it is centered in the bore by a neoprene O-ring. With adapters you can — share your shooting enjoyment with the family. 410 shells cost less and there's almost no recoil — hunt woodcock, quail or other small game. Control pests around the farm or home.



TWO GUNS FROM ONE SINGLE BARREL

Double Your Sport... Double Your Fun With The "Four-Tenner"



Fox and Stevens Double Barrel Shotguns

SPORTSMEN THE WORLD OVER PREFER A DOUBLE GUN.

It's easy to see why. From the early days of European gunsmithing the graceful lines, slim profile and ease of handling have made it a traditional favorite among true sportsmen. Doubles point faster, carry easier because of their short, compact frame design and thus, shorter overall length.

Fox Model B-SE: 12, 20 and 410 gauges.

Automatic ejectors are standard equipment on the Fox B-SE. Other fine gun features are the single trigger and ventilated rib. The handsome B-SE has the beautiful lines found only in a double gun, enriched with materials and finishes typical of expensive custom guns.

Fox Model B: 12, 20 & 410 gauges. (12 and 20 gauge in 3" magnum.)

For sheer beauty of design, fine balance and fast handling, nothing equals a double - the traditional sporting gun. And there isn't anything like the Fox B at anywhere near its price. Standard equipment includes ventilated rib, checkering, select walnut stock with fluted comb, beaver-tail fore-end. Two triggers give the shooter instant command of two shots - the split second choice of two chokes.

New Fox Model BE: 12, 20 and 410 gauges. (12 and 20 gauge in 3" magnum.)

Same as Fox B except with automatic ejectors. The two triggers give you instant choice of two chokes. Plus 3" magnum chambering in 12 and 20 gauge.



Use a Savage "Four-Tenner" in 12 or 20 gauge guns for greater versatility.



The Stevens Model 311: 12, 16, 20 & 410 gauges. (12 and 20 gauge in 3" magnum.)
 This double barrel shotgun is the outstanding value of the double gun field, with many refinements usually found only in higher priced guns. Its sturdy construction, solid lockup, excellent balance and superior shooting qualities are appreciated by many thousands of satisfied users throughout the world.

FEATURES

MODEL	BSE	311	B or BE
VENT RIB	•		•
SOLID RIB		•	
AUTOMATIC TOP TANG SAFETY	•	•	•
EXTRACTORS		•	•
SELECTIVE EJECTORS	•		•
TRIGGER	SINGLE	•	
	DOUBLE		•
STOCK	SELECT WALNUT	•	•
	CAPPED PISTOL GRIP, FLUTED COMB.	•	•
	WALNUT FIN. HARDWOOD		•
BEAD SIGHTS	2	•	•
	1		•

SPECIFICATIONS: BARREL-CHOKE-CHAMBER

MODEL	BSE			311			B or BE			
	12	20	410	12	16	20	410	12	20	410
GAUGE	26" I. C. & M.	•	•		•		•	•	•	
	26" F & F			•						•
	28" M & F	•	•		•	•		•	•	
	30" M & F	•						•		
CHAMBERED FOR	2 3/4"	2 3/4" & 3"	2 1/2" & 3"	2 3/4" & 3"	2 3/4"	2 3/4" & 3"	2 1/2" & 3"	2 3/4" & 3"	2 3/4" & 3"	2 1/2" & 3"
	OVERALL	41 3/4" - 45"			41 3/4" - 45"			41 3/4" - 45"		
LENGTH	TAKEN DOWN	26" - 30"			26" - 30"			26" - 30"		
	STOCK	14"			14"			14"		
	COMB	1 1/2"			1 1/2"			1 1/2"		
DROP AT	HEEL	2 1/2"			2 1/2"			2 1/2"		
	AVERAGE WEIGHT (LBS.)	6 1/2-8			6 1/2-8			6 1/2-8		

I. C. - Improved Cylinder M - Modified F - Full



Fox B-SE

Note: The only American-made production doubles.
 American made at a realistic price.
 Fox doubles have many deluxe features.
 Vent rib and automatic ejectors.
 Well over one million sportsmen carry these doubles.



Stevens 311

Note: Magnum chambering at no extra cost.
 Automatic top tang safety.
 Double triggers for instant barrel selection.
 Fox doubles have many deluxe features.

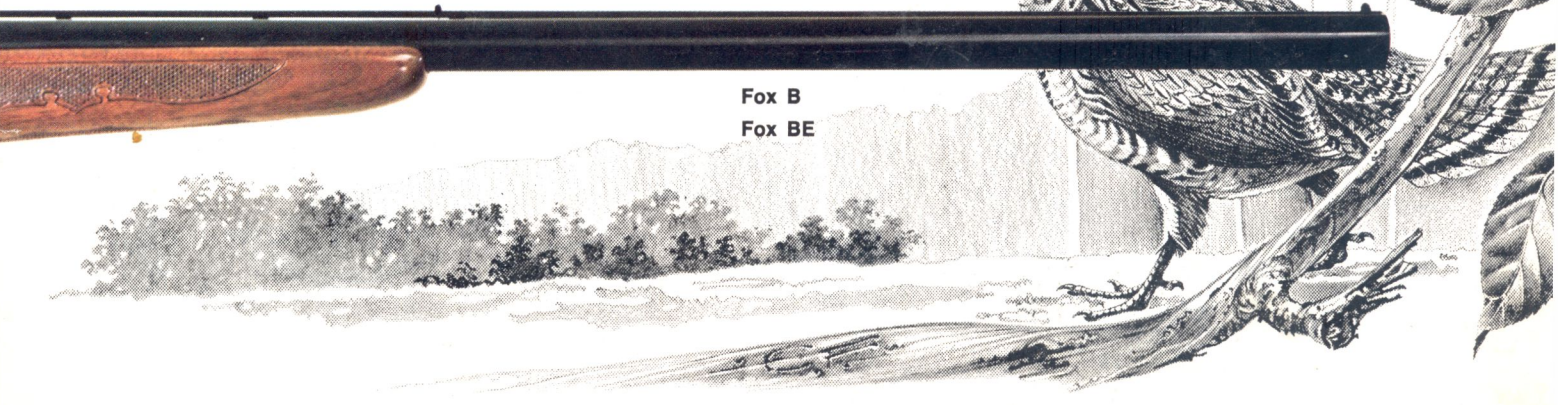

**Fox B
 Fox BE**



Stevens Single Barrel Shotguns

Stevens Model 94-C; 12, 16, 20 and 410 gauge.

Still the most popular single barrel shotgun ever made. The 94-C has the dependable hammer style action preferred by many. Opening lever on top tang swings either way-equally convenient for right- or left-hand operation. Powerful ejector functions automatically when gun is opened. Checkered, walnut finished hardwood stock and fore-end. Fore-end is grooved for better handling. Available with 36 inch "Long Tom" barrel in 12 gauge.

Stevens Model 94-Y Youth Model: 20 and 410 gauges.

Top lever opening. Has shorter stock with rubber recoil pad. 26 inch barrel, 20 gauge modified or 410 gauge full choke.

Stevens **Super Value** Model 9478: 10, 12, 20, 410 gauges.

A new and exciting single barrel shotgun design destined to become a favorite among beginning and experienced hunters alike.

Special Features:

Manual cocking, visible hammer, rugged coil spring. Automatic ejection and new design bottom-opening lever convenient for either right- or left-hand use. Frame has color, case-hardened finish.

Stevens **Super Value** Model 9478:

10 gauge Waterfowl is fitted with special 36" barrel. Stock is fitted with rubber recoil pad, and fore-end is grooved for super grip.

Stevens **Super Value** Model 9478-Y Youth Model: 20 and 410 gauges.

Bottom opening lever. Has shorter stock with hard rubber butt plate. 26 inch barrel, 20 gauge modified or 410 gauge full choke.





FEATURES

MODEL	94-C - 94-Y	9478 - 9478-Y
2-WAY TOP LEVER OPENING	•	
BOTTOM OPENING LEVER		•
AUTO. EJECTOR	•	•
STOCK WAL. FIN. HARDWOOD	•	•
FORE-END WAL. FIN. HARDWOOD	•	•

SPECIFICATIONS: BARREL-CHOKE-CHAMBER

MODEL		9478* - 94-C						9478-Y - 94-Y	
GAUGE		10	12	16	20	410	20	410	
BARREL LENGTHS & CHOKES	26" F					•		•	
	26" M						•		
	28" F		•	•	•				
	30" F		•						
	32" F		•						
	36" F		•						
CHAMBERED FOR		2 7/8" & 3 1/2"	2 3/4" & 3"	2 3/4"	2 3/4" & 3"	2 1/2" & 3"	2 3/4" & 3"	2 1/2" & 3"	
LENGTH	OVERALL	42" - 52"						40 1/2"	
	TAKEN DOWN	26" - 36"						26"	
DROP AT	STOCK	14"						12 1/2"	
	COMB	1 1/2"						1 1/2"	
	HEEL	2 1/2"						2 1/2"	
AVERAGE WEIGHT (LBS.)		8 1/2	6 - 6 1/4				5 1/2		

*MODEL 9478 NOT AVAILABLE IN 16 GAUGE OR 12 GAUGE 32" F



94-C

Note:

Over 50 years old and still the most popular.
 Over one million sportsmen can't be wrong.
 Magnum chambering at no extra cost.
 Ideal for the beginner shooter.
 Forged one piece automatic ejector.



9478
10 Gauge magnum

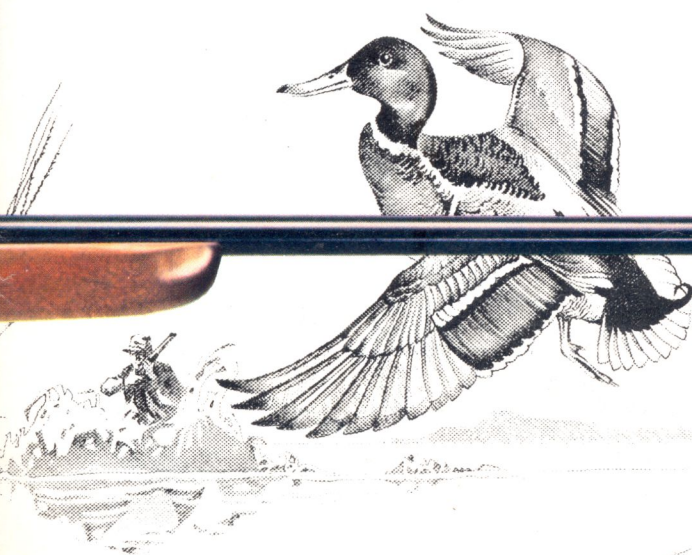

9478

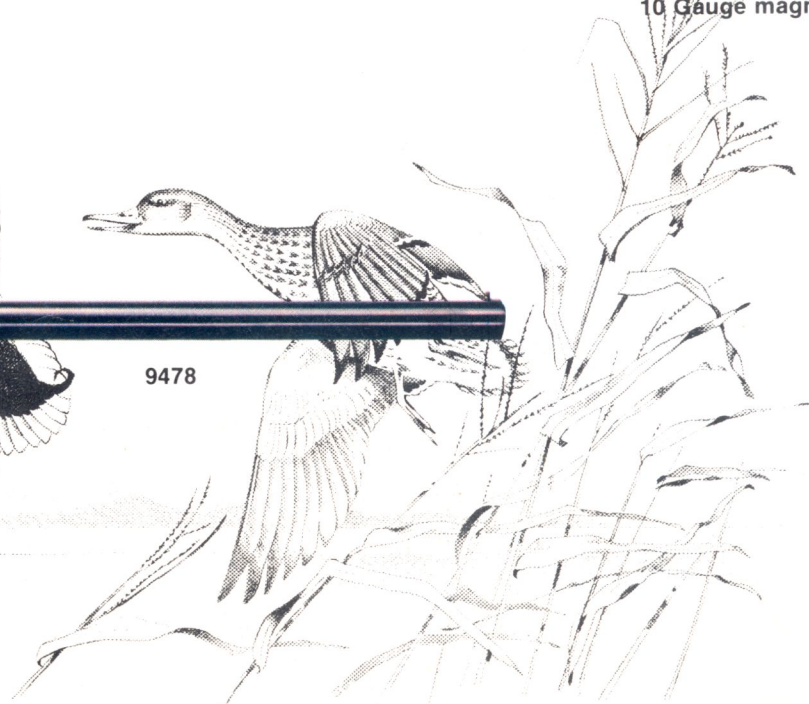



Savage 99 Lever Action Center Fire Rifles

Why is it accurate?

Let's start with the 99's stock. Through its heart runs a rugged bolt that locks stock to receiver like a vise holds wood. Result? Stock and receiver always act as one, contributing greatly to accuracy.

Then there's the short stroke lever for faster operation.

And when it's open no working parts are exposed to weather. Unlike ordinary lever actions that start to cock the hammer while ejecting the shell, the 99 does it in two easy stages, avoiding a double load. Down ejects the case. The return stroke does the cocking. The whole motion is smoother and faster, increasing your effective fire power.

Signature Model 99-CD The North American Classic - Calibers: 250 Savage; 308, and 243

Time-tested Savage design plus added features, which will appeal to the most serious shooter, are combined in the 99-CD detachable box magazine rifle. As a final touch - the Savage Signature medallion pistol grip cap to highlight the top of our lever action line.

Special Features:

Select walnut stock designed with a high Monte Carlo, cheek-piece and deeply fluted comb. Stock and grooved fore-end hand checkered with swivels. Detachable hooded ramp front sight, rear sight adjustable for elevation and windage. Truly a long-awaited addition to the Savage tradition of quality.

Model 99-C Calibers: 243 and 308, 22-250

Another Savage 99 with detachable box magazine. Makes loading and unloading fast. An extra loaded clip means reserve firepower is ready when needed. Clip follows the graceful contours of the receiver; locks into place instantly and ejects when you press release button (recessed in receiver to protect against accidental release). Extra magazine available (specify caliber).



FEATURES

MODEL		99-CD	99-C
TAPPED FOR TOP MOUNTED SCOPE		•	•
CHROME MOLY STEEL BARREL		•	•
COCKING INDICATOR		•	•
MAGAZINE CLIP		•	•
TOP TANG SAFETY		•	•
STOCK & FORE-END	SELECT WALNUT. RECOIL PAD (99-CD) HAND CUT CHECKERING	•	•
FRONT SIGHTS	REMOVABLE HOODED RAMP	•	
REAR SIGHTS	REMOVABLE RAMP		•
REAR SIGHTS	REMOVABLE ADJUSTABLE FOLDING LEAF	•	
FRONT SIGHTS	FOLDING LEAF		•

SPECIFICATIONS

MODEL		99-CD	99-C
LENGTH	OVERALL	41 3/4"	41 3/4"
	BARREL	22"	22"
	STOCK	13 1/2"	13 1/2"
DROP AT	COMB	1 5/8"	1 1/2"
	MONTE CARLO	1 1/2"	
	HEEL	2 1/2"	2 1/2"
AVERAGE WEIGHT (LBS.)		8 1/4	7
CARTRIDGE CAPACITY*		5	5
RATE OF TWIST (R.H.)		1 TURN IN 10" FOR 250 SAV & 243	
		1 TURN IN 12" FOR 308 & 358	
		1 TURN IN 14" FOR 22-250	

*Includes one (1) in chamber



99-CD signature medallion pistol grip cap.



99-CD cheek-piece and hand checkering.



99-CD



99-C

Well over one million sportsmen carry a Savage 99. Only American-made lever action repeater capable of handling the powerful 308 cartridge.

Note: Patented ejector clip magazine.

Solid steel receiver goes through over 100 machining operations.

Top tang safety for both right- and left-hand use.





Savage 99 Lever Action Center Fire Rifles

Model 99A Calibers: 243, 308 and 250 Savage

History and modern manufacturing combine to make this lever action rifle with the straight (saddle) stock with steel butt plate and the schnabel fore-end. The same fine rotary action in the solid steel receiver that has proven itself for years in the 99 line.

Model 99-358 Caliber: 358

Much recent demand for a rifle in a caliber with brush-bucking performance has necessitated the introduction of this rifle.

A fast-handling rotary magazine rifle with straight stock with recoil pad, grooved fore-end for firmer control, fitted with swivel studs. Another long-awaited addition to the Savage 99 line.

Model 99-E Calibers: 300 Savage; 243 and 308

Here's the classic high power Savage lever action with all the solid virtues of its time-tested design without any frills to increase the cost. Now there's no need to settle for a lever action in less powerful calibers. An outstanding value.

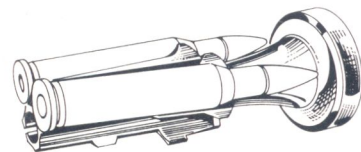

Time-tested rotary magazine



FEATURES

MODEL		99-A	99-358	99-E
TAPPED FOR TOP MOUNT SCOPE		•	•	•
CHROME MOLY STEEL BARREL		•	•	•
COCKING INDICATOR		•	•	•
MAGAZINE	ROTARY	•	•	•
CARTRIDGE COUNTER		•	•	
SAFETY	TOP TANG	•	•	
	SLIDE BOTTOM TANG			•
STOCK & FORE-END	SELECT WALNUT	•	•	
	WAL. FIN. HARDWOOD			•
SIGHTS	FRONT: REMOVABLE	•	•	•
	REAR: FOLDING LEAF	•	•	•

SPECIFICATIONS

MODEL		99-A	99-358	99-E
LENGTH	OVERALL	41¾"	41¾"	41¾"
	BARREL	22"	22"	22"
	STOCK	13½"	13½"	13½"
DROP AT	COMB	1½"	1½"	1½"
	HEEL	2½"	2½"	2½"
AVERAGE WEIGHT (LBS.)		7	7	7
CARTRIDGE CAPACITY*		6	6	6
		1 TURN IN 10" FOR 250 SAV. & 243		
RATE OF TWIST (R.H.)		1 TURN IN 12" FOR 300 SAV., 358 & 308		

*Includes one (1) in chamber



99-A

Well over one million sportsmen carry the Savage 99.

Note:

The only American-made lever action rifle capable of handling the powerful 308 cartridge.

Over 100 machining operations go into each 99 receiver.



99-358

Classic rotary magazine.

Note:

Tapped for scope mounting low, directly over receiver.

Hand-me-down durability.



99-E





Savage Pump Action Center Fire Rifle and Carbine

Model 170 Calibers: 30-30, 35

Until it was introduced deer and black bear hunters had little real choice when it came to a dependable, rapid-fire rifle at a modest price.

The 170's pump action is a natural action. A front-to-back motion that's in the line of sight so your sights stay on the target.

Quiet Performance. When stalking or on stand, any sound can cost you your deer — the Silent-Lok feature muffles slide handle sound.

Model 170-C (Carbine) 30-30

The 170 is offered in an even faster handling carbine variation. Shorter barrel (18½"). Sporter stock and Silent-Lok feature. The 170-C is a natural in heavy brush hunting or at close quarters where quick reactions plus a smooth functioning and fast handling carbine could mean the difference.

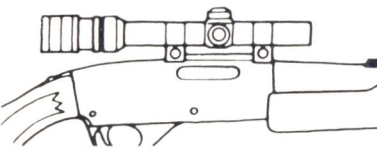

Receiver drilled and tapped to mount scope.

Savage No. 70 (Integral Bases and Rings) Mount.

A tough, inexpensive two piece steel mount for the Savage 170 and 170-C. Top mounted for over-the-bore position. Two piece integral bases and rings, complete.



FEATURES

MODEL		170	170-C
TAPPED FOR TOP MOUNTED SCOPE		•	•
TOP TANG SAFETY		•	•
TUBULAR MAGAZINE		•	•
STOCK: SELECT WALNUT		•	•
SLIDE HANDLE: SELECT WALNUT		•	•
SIGHTS	FRONT: REMOV. RAMP	•	•
	REAR: FOLDING LEAF	•	•

SPECIFICATIONS

MODEL		170	170-C
LENGTH	OVERALL	41½"	38"
	BARREL	22"	18½"
	STOCK	14"	14"
DROP AT	COMB	1½"	1½"
	MONTE CARLO	1½"	
	HEEL	2½"	2½"
AVERAGE WEIGHT (LBS.)		6¾	6
CARTRIDGE CAPACITY*		4	4
RATE OF TWIST (R.H.)		1 TURN IN 12" FOR 30-30 & 35	

* Includes one (1) in chamber





Savage 110-C, 110-CL, 110-S, 112-R

THE ULTIMATE

in Bolt Action Center Fire Rifles

Model 110-C (right-hand) 110-CL (left-hand) Calibers: 30-06 Spfld., 270, 243 and 7 mm Magnum.

The solid features of the 110 plus the detachable box magazine for convenient loading and unloading. To unload, press the recessed button and out pops the magazine with the shells neatly held and tips protected! An extra loaded magazine in a jacket pocket provides additional firepower.

- Receiver is machined from a solid steel bar.

Exciting Features:

- Most complete gas protection system.
- Three massive gas baffles.
- Exclusive twin gas ports in receiver and one in bolt head itself.
- Ejector clip magazine fits flush with stock.
- Rear of bolt is sealed off.
- Top tang safety

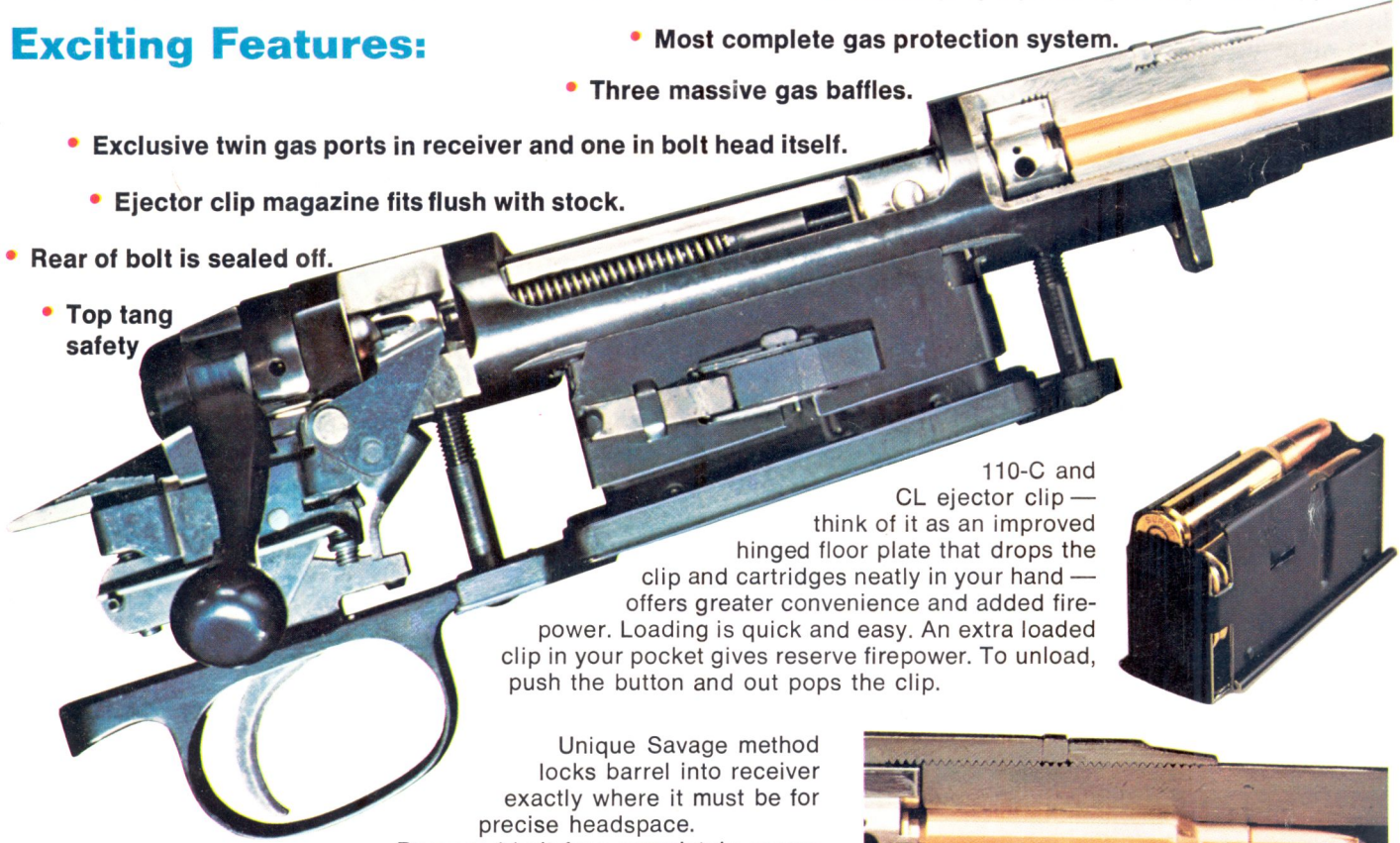

110-C and CL ejector clip — think of it as an improved hinged floor plate that drops the clip and cartridges neatly in your hand — offers greater convenience and added firepower. Loading is quick and easy. An extra loaded clip in your pocket gives reserve firepower. To unload, push the button and out pops the clip.

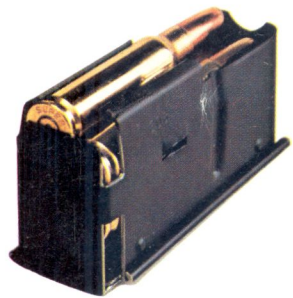

Unique Savage method locks barrel into receiver exactly where it must be for precise headspace.

Recessed bolt face completely covers and supports cartridge head. Two massive, heat-hardened steel locking lugs fit intimately to steel receiver. Result — all the strength you expect from a bolt action rifle.

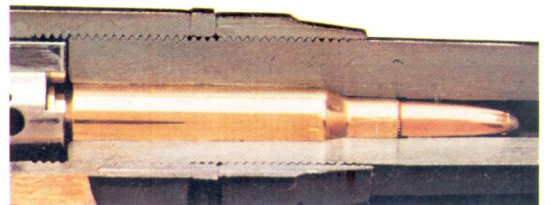

Exclusive twin gas ports in receiver, gas baffle lugs on bolt and bolt end cap give most complete protection you can get. And our new Satinslide bolt gives you a smoother, faster working action.

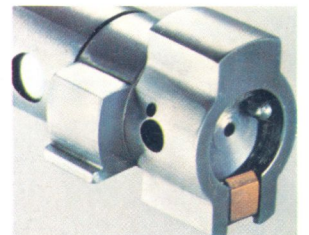
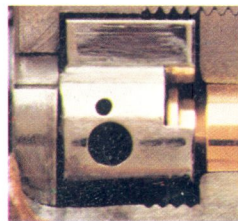
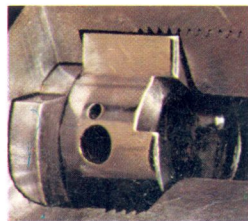

110-CL

For Complete Specifications on C-CL see page 17.



Savage Bolt Action Center Fire Rifles

Model 110-S Silhouette Rifle (right-hand only) Caliber: 308
Metallic Silhouette shooting is the fastest growing shooting sport today. Savage has once again responded to the many inquiries with a rifle especially designed for this great shooting sport.

Special Features:

The many famous 110 action features have been combined with a heavy 22" tapered barrel (7/8" diameter at the muzzle) for greater accuracy. Receiver is drilled and tapped for scope mounting, satin blue finish on receiver to reduce light reflection. The barrel is free floating in special "Silhouette" stock of select walnut, has high fluted comb, hand filling, Wundhammer swell pistol grip for both right and left-hand use. Anschutz style stippled checkering on pistol grip and under the fore-end. Stock is fitted with rifle recoil pad. All these features will surely make the 110-S a favorite in matches the country over.

New Model 112-R (Repeater) The Varmint Hunter's Varmint Rifle—Calibers: 22-250, 25-06

The only true varmint rifle made today with the varmint hunter in mind.

Special Features:

A 26" tapered barrel (13/16" diameter at muzzle) for greater accuracy. Receiver is drilled and tapped for scope mounting. Blocks are also provided for target type scopes. Free floating barrel in special varmint stock of select walnut has high, deeply fluted comb, Wundhammer swell pistol grip for right- or left-hand use. Stock is fitted with white-line recoil pad and 1 1/4" quick detachable swivel loops.





Put all these together with time-tested Savage features, such as unique method headspacing, top tang safety, Satinslide bolt and massive locking lugs—you have very potent varmint medicine.

FEATURES

MODEL		110-C, CL	110-S	112-R
TAPPED FOR TOP MOUNTED SCOPE		•	•	•
FREE FLOATING CHROME MOLY BARREL		•	•	•
TOP TANG SAFETY		•	•	•
CLIP MAGAZINE		•	•	•
INTERNAL BOX MAGAZINE		•	•	•
STOCK	SELECT WALNUT	•	•	•
BUTT	HARD RUBBER	STD. CAL.		
PLATE	RECOIL PAD	MAG.	•	•
FRONT SIGHTS	HOODED REMOVABLE RAMP	•		BLOCKS FOR SCOPES
REAR SIGHTS	FOLDING LEAF	•		

SPECIFICATIONS*

MODEL		110-C, CL *		110-S	112-R
CALIBER		STD.	MAG.		
LENGTH	OVERALL	43"	45"	43"	47"
	BARREL	22"	24"	22"	26"
DROP AT	STOCK	13½"		13½"	13½"
	COMB	1½"		1¾"	¾" □
	MONTE CARLO	1½"		1¼"	
HEEL		2¼"		2¼"	¾" □
AVERAGE WEIGHT (LBS.)		7-7¾		(MAX. 8 lbs. 10 oz.)	9¼
CARTRIDGE CAPACITY**		5	4	5	5
RATE OF TWIST (R.H.)		1 TURN IN 9½" FOR 7 MM. REM. MAG.			
		1 TURN IN 10" FOR 25-06, 243, 30-06 & 270.			
		1 TURN IN 14" FOR 22-250 & 12" FOR 308			

* Left-hand rifles built to same specifications, except with left-hand stocks and actions.
 ** Includes one (1) in chamber
 □ Measured from barrel center line



110-C

Note: Recessed bolt face.
 Unique, accurate headspace system.
 Most complete gas protection system.
 Ejector clip magazine fits flush with stock.
 Satin-smooth action.
 Tapered, chrome-moly steel barrel.
 Fully adjustable folding leaf rear sight.
 Detachable hooded front sight.



Model C-CL Monte Carlo stock with cheek-piece.

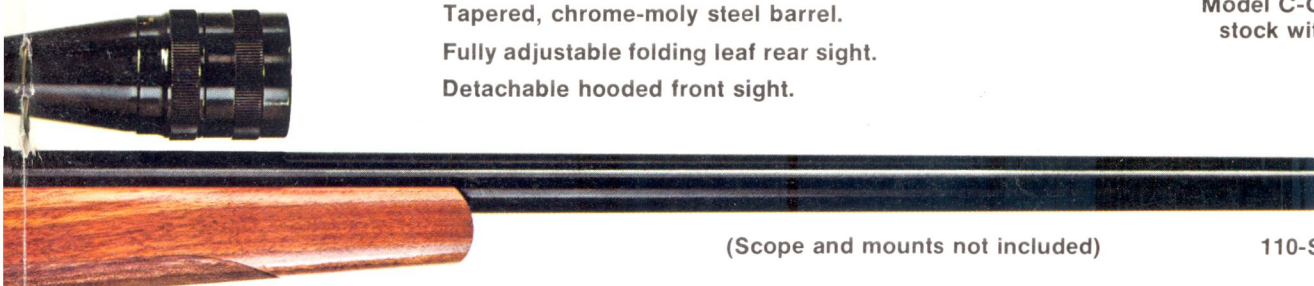

(Scope and mounts not included)

110-S

Note: Receiver is machined from a solid steel bar.
 Top tang safety for right- or left-hand use.
 Only true varmint rifle made today (112-R).
 Free-floating, heavy, tapered, chrome-moly steel barrel.
 Wundhammer swell pistol grip.



(Scope and mounts not included)

112-R

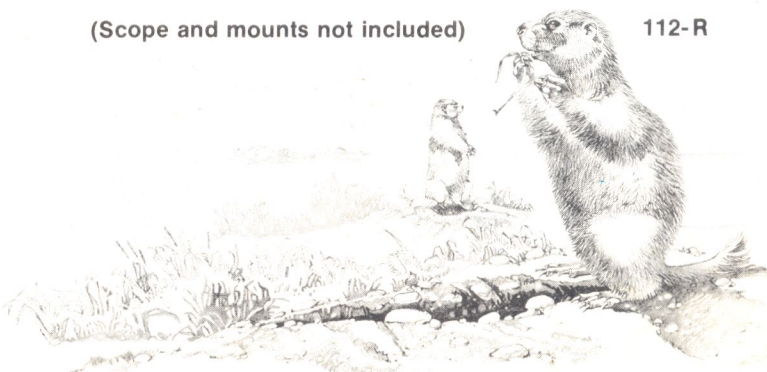



Savage 340 and Anschutz 1432 Bolt Action Center Fire Rifles

Anschutz Model 1432 Caliber: 22 Hornet

Known the world over for accuracy and quality, Anschutz has introduced this handsome sporter featuring a custom Monte Carlo stock with roll-over cheek-piece, contoured pistol grip and graceful schnabel fore-end. Grip and fore-end are lavishly hand checked in a skip-line pattern. The stock is of select walnut. Receiver is grooved for scope mount and drilled and tapped for scope bases. All these custom features add up to a winner in the true Anschutz tradition.

1432 Extra clip available (5 shot)

Savage Model 340 Calibers: 30-30; 22 Hornet; 222, 223

Proper headspace is vital for accuracy. Precision headspacing of the 340, achieved by a unique Savage method for exceptional performance. The bolt locks up in front, for greater strength and accuracy. The barrel is precision rifled and the muzzle is crowned.

The bolt handle is curved. The streamlined stock is American walnut, complete with checkering, Monte Carlo, pistol grip cap and white line spacers.

Savage No. 40 One Piece Mount

A sturdy and inexpensive steel mount for one inch scopes. Savage 340 is drilled and tapped on the left side for this mount. Places scope in the normal over-the-bore position. One piece mount, complete.



SPECIFICATIONS

MODEL	340		1432
CALIBER	22 HORNET 222 223	30-30	22 HORNET
LENGTH	OVERALL	43"	43 1/2"
	BARREL	24"	24"
	STOCK	13"	14"
DROP AT	COMB	1 3/4"	1 5/8"
	MONTE CARLO	1 3/4"	2 1/16"
	HEEL	2 1/2"	1 1/4"
AVERAGE WEIGHT (LBS.)	7 1/2	7 1/4	6 3/4
CARTRIDGE CAPACITY*	5	4	5
RATE OF TWIST (R.H.)	1 TURN IN 12" FOR 30-30		
	1 TURN IN 14" FOR 222 & 223		
	1 TURN IN 16" FOR 22 HORNET		

*Includes one (1) in chamber

FEATURES

MODEL	340	1432
TAPPED FOR SCOPE MOUNTS	•	•
THUMB SAFETY	•	•
WING SAFETY	•	•
CLIP MAGAZINE	•	•
STOCK SELECT WALNUT	•	•
SIGHTS	FRONT REMOV. RAMP	•
	FRONT HOODED RAMP	•
	REAR FOLDING LEAF	•

The 340 is available in four popular calibers



Extra clips available (specify caliber)

Savage/Anschutz & Anschutz 22 Sporters

Model 54 Sporter 22 long rifle. Model 54-M 22 Magnum.

The model 54 Sporter combines the world's most accurate small-bore action with a handsome sporting stock that would do credit to the finest custom stock-maker. The Monte Carlo stock of select walnut is strictly custom grade from the hand-carved roll-over cheek-piece and contoured pistol grip to the graceful schnabel fore-end. Both fore-end and pistol grip are lavishly hand checkered in a skip-line pattern. Receiver is grooved for scope mount and drilled and tapped for scope bases.

The 54-M magnum offers Anschutz-accurate shooting up to 100-125 yards for the varmint and small game hunter. Exceptional Anschutz accuracy makes the 54-M a natural for the magnum cartridge.

54 Extra clips available (specify 5 or 10 shot)

54-M Extra clips available (4 shot only)

Model 164 22 long rifle. Model 164-M 22 Magnum.

Here's the blood brother of the 54 Sporter, the rifle that has been so much in demand by sportsmen. The action of the 164 is the same one used on the popular Savage/Anschutz model 64 target rifle. The barrel is precision bored for

pinpoint accuracy. Receiver is grooved for instant scope mounting. The select walnut stock has custom grade features - Monte Carlo with cheek-piece, Wundhammer swell pistol grip, schnabel fore-end and cut checkering. The 164-M is chambered for the 22 magnum cartridge for those longer range shots.

164 Extra clips available (specify 5 or 10 shot)

164-M Extra clips available (4 shot only)

Anschutz Model 1418 22 long rifle Model 1518 22 Mag.

The action is the same as the popular model 164 but the stock is completely European. This compact Mannlicher sporter is bound to be an American favorite, just like its predecessor, the model 164. With features such as a choice of double set or single stage triggers, hand cut skip-line checkering, stock inlays and European style Monte Carlo stock with cheek-piece, to name just a few.

1418 Extra clips available (specify 5 or 10-shot)

1518 Extra clips available (4-shot only)

Available on special order only. For further information contact your dealer or write Savage Arms, Westfield, Massachusetts 01085.

FEATURES

MODEL	54 & 54-M	164 & 164-M	1418 & 1518
GROOVED FOR SCOPE	•	•	•
TAPPED FOR SCOPE MOUNT	•		
FACTORY SET TRIGGER	•	•	•
CLIP MAGAZINE	•	•	•
SAFETY	WING	•	
	SLIDE		•
STOCK: SELECT WALNUT	•	•	•
SIGHTS	FRONT: HOODED RAMP	•	•
	REAR: FOLDING LEAF	•	•

SPECIFICATIONS

MODEL	54 & 54-M	164 & 164-M	1418 & 1518	
LENGTH	OVERALL	43"	40 ³ / ₄ "	37 ⁵ / ₈ "
	BARREL	24"	23"	19 ³ / ₄ "
	STOCK	14"	14"	13 ¹ / ₂ "
DROP AT	COMB	1 ¹ / ₄ "	1 ¹ / ₂ "	1 ⁵ / ₈ "
	MONTE CARLO	1 ¹ / ₄ "	1 ¹ / ₂ "	2 ¹ / ₈ "
	HEEL	1 ¹ / ₄ "	2 ¹ / ₄ "	2 ³ / ₈ "
AVERAGE WEIGHT (LBS.)	6 ³ / ₄	6	5 ¹ / ₂	
CARTRIDGE CAPACITY*	6**	5**	6**	5**
RATE OF TWIST (R.H.)	1 TURN IN 16" FOR 22 L.R. & 22 MAG.			

* Includes one (1) in chamber

** NOTE: Models 54, 164, and 1418 are chambered for 22 long rifle ONLY
Models 54-M, 164-M, and 1518 are chambered for 22 WMR ONLY



54

164

1418
1518



Savage-Stevens 22 Rifles

Savage Model 80 22 long rifle.

This deluxe autoloader has the style and feel of a high power rifle. Checkering, Monte Carlo stock. White-line pistol grip cap and butt plate. The tubular magazine holds 15 22 long rifle cartridges. This dependable autoloader performs as well as it looks. Grooved receiver for instant scope mounting. Set your sights on a deluxe autoloader - choose the Savage model 80.

Savage Model 65-M, 22 Magnum.

The Savage 65-M, with select walnut Monte Carlo stock, is patterned after a high powered rifle. The solid steel receiver houses a smooth, fast bolt action with crisp trigger pull. Action is dependable, with bolt encased in the receiver, a recessed bolt face, and double extractors.

Stevens Model 34, 22 long rifle.

Has checkered walnut finished hardwood stock with Monte Carlo, solid steel receiver and fast, smooth bolt action with crisp trigger pull. Convenient thumb safety at rear of the receiver for easy operation. The receiver is grooved for scope mounting.

65-M Extra clips available (5 shot only)

34 Extra clips available (specify 5 or 10 shot)

Stevens Model 89, 22 long rifle.

This little single shot has the balance and feel of a traditional western carbine. Featuring western style lever action with a rugged Martini-type breech block, automatic ejection. Hammer must be cocked by hand independent of the lever prior to firing. Ideal for that young beginner.

Stevens Model 73, 22 long rifle.

For the man or boy choosing his first gun - for anyone who wants a dependable bolt action rifle at a reasonable price. Safety goes on automatically when the bolt is operated - an ideal design for a first rifle. The free-floating barrel is precision rifled. With a handsome stock and streamlined receiver.

Stevens Model 73-Y Youth Model, 22 long rifle.

Same as 73 except shorter barrel and stock and the weight is only 4¼ pounds. Truly a good choice for a youngster.

Stevens Model 72 Crackshot, 22 long rifle.

This unique falling block action is a pleasure to handle, shoot or simply admire. It has balance, smooth functioning and safety. This popular 22 rifle is truly in the great Stevens tradition. It features an octagonal barrel, case hardened frame, walnut stock and fore-end with oil finish.





FEATURES

MODEL	80	34	65-M
GROOVED FOR SCOPE	•	•	•
MAGAZINE	TUBULAR		
	CLIP		
SIDE SAFETY	•	•	•
STOCK	SELECT WALNUT		
	WAL. FIN. HARDWOOD		
SIGHTS	FRONT: SPORTING		
	FRONT: RAMP		
	REAR: OPEN		

SPECIFICATIONS

MODEL	80	34	65-M
LENGTH	OVERALL 40"	39"	41"
	BARREL 20"	20"	22"
	STOCK 14"	14"	14"
DROP AT	COMB 1½"	1½"	1½"
	MONTE CARLO 1⅞"	1⅞"	1⅞"
	HEEL 2½"	2½"	2½"
AVERAGE WEIGHT (LBS.)	6	5½	5¾
CARTRIDGE CAPACITY*	16**	6**	6**
RATE OF TWIST (R.H.)	1 TURN IN 16" FOR 22 L.R. AND 22 MAG.		

* Includes one (1) in chamber.

** NOTE: Model 80 chambered for 22 Long Rifle ONLY; Model 34 for 22 Long Rifle, and 22 Long or Short; Model 65-M for 22-WMR ONLY.

FEATURES

MODEL	89	72	73	73-Y
SINGLE SHOT	•	•	•	•
FRAME	SATIN BLACK			
FINISH	CASE HARDENED			
VISIBLE HAMMER	•	•		
MANUAL COCKING	•	•		
AUTOMATIC SAFETY			•	•
STOCK & FORE-END	SELECT WALNUT			
	WAL. FIN. HARDWOOD			
SIGHTS	FRONT: SPORTING			
	REAR: OPEN			

SPECIFICATIONS

MODEL	89	72	73	73-Y
LENGTH	OVERALL 35"	37"	33½"	35"
	BARREL 18½"	22"	20"	18"
	STOCK 14"	14"	14"	12½"
DROP AT	COMB 1¾"	1¾"	1½"	1½"
	HEEL 2¾"	2¾"	2½"	2½"
AVERAGE WEIGHT (LBS.)	5	4½	4¾	4½
CARTRIDGE CAPACITY	1*	1*	1*	1*
RATE OF TWIST (R.H.)	1 TURN IN 16" FOR 22 L.R.			

* Chambered for 22 Long Rifle, Long, or Short



Anschutz Target Rifles



ANSCHUTZ is respected throughout the world as one of the finest rifles available for small bore competitive shooting. At Montreal, Camp Perry and at national and international matches, an ANSCHUTZ is the preferred choice.

Now, ANSCHUTZ has made their great rifles even greater. . . Completely New Revolutionary Triggers and Bolt Design for the Models 1413, 1411 and 1407.

Model 1413 Super Match 54.

The Free-style International target rifle that has and should continue to dominate international competition. For these very telling reasons:

A Superb Match 54 bolt design that is satin smooth. Very short firing pin travel for improved lock time. Conveniently located side safety. The model 5071 Match Two-Stage Triggers (see trigger specification) are even faster, even more precise and reliable. The mechanism reaction time is reduced. Other features include combination hand-stop/sling swivel, hook butt plate for right- and left-hand use, No. 4840 adjustable palm rest and adjustable butt plate and cheek-piece. The 1413 — a winner in the true international tradition. Left-hand stock 1413-L (sights extra).

Model 1407 Match 54

Meets all existing International Shooting Union requirements and is currently suitable for All N.R.A. matches. Has satin smooth Match 54 bolt design, just like the 1413. Also, the 5071 Match Two-Stage (see trigger specifications) for precise and reliable adjustments.

Convenient side safety. The whole stock and pistol grip are sculptured to fit the shooter whether it be a prone or position match. Hand stop/sling swivel are included. 1407 right-hand, 1407-L left-hand (sights extra).

Model 1411 Match 54

Here's the world famous Anschutz prone rifle with the Match 54 bolt design. Very short firing pin travel for extremely fast lock time. Conveniently located side safety. Model 5075 Match Single Stage Triggers (see trigger specifications) are even faster, even more precise and reliable. The mechanism reaction time is reduced. Other features include adjustable cheek-piece, combination hand-stop sling swivel and adjustable butt plate. The 1411 right-hand and left-hand 1411-L (sights extra).

Anschutz Barreled Actions.

Now available Match 54 barreled actions in the following designations:

- A. 1413-U2 with two-stage trigger 5071 for model 1413.
 - B. 1411-D-U3 with single stage trigger 5075 for model 1411.
 - C. 1407-U6 with two-stage trigger 5071 for model 1407.
- Barreled actions include barrel, action and triggers.

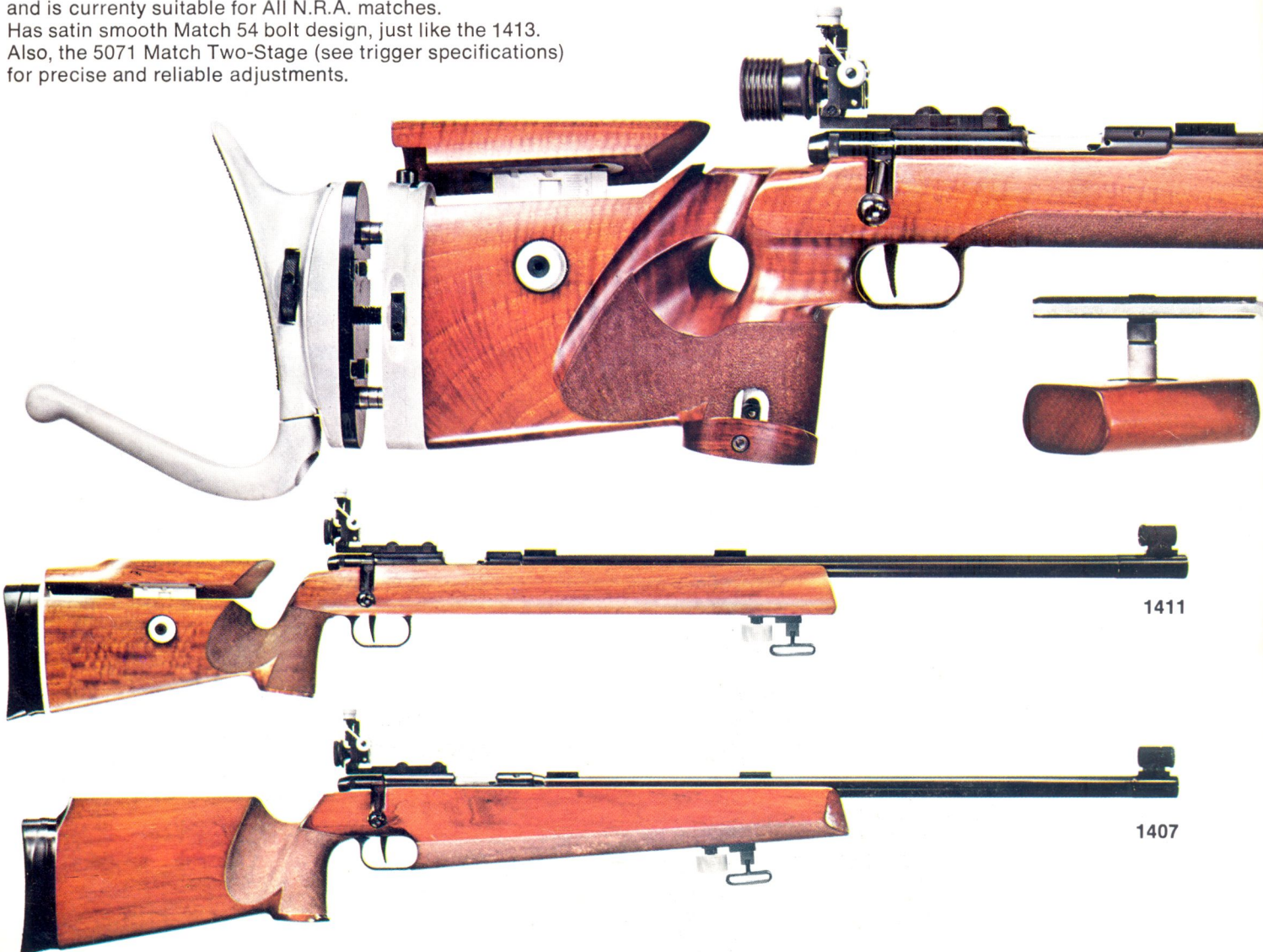

Model 1408ED "Super" Running Boar Rifle.
Available on special order only, For further information

contact your dealer or write Savage Arms, Westfield, Massachusetts 01085.

SPECIFICATIONS - FEATURES			
	1413 1413-L	1411 1411-L	1407 1407-L
BARREL	Precision rifled, hand-lapped. 22 long rifle only.		
Length	27 1/2". Extra heavy, 1 5/16" diameter.		26". 7/8" diameter.
ACTION	Bolt action, single shot. Double locking lugs. Large loading platform.		
SAFETY	Side safety attached to trigger assembly.		
STOCK	Select walnut, adjustable cheek-piece. Cast-off. Long swivel rail.		Select walnut, cheek-piece. Cast-off. Long swivel rail.
	International type, cheek-piece.		Monte Carlo, cheek-piece.
Butt Plate	Variable angle hook for right or left-hand use.		Non-slip rubber, spacer and vertical adjustment.
SIGHTS	Receiver grooved for Anschutz sights. Scope blocks. (Sights extra).		
LENGTH	50"	46"	44 1/2"
WEIGHT (avg.)	15 1/2 lbs.	11 lbs.	10 lbs.
Left-hand rifles built to same specifications, except with left-hand stock, cast-off.			RATE OF TWIST (R.H.) 1 turn in 16" for 22 L.R.

TRIGGER SPECIFICATIONS						
MATCH TWO-STAGE TRIGGERS						
Trigger Model	Rifles with Side Safety	Rifles with Wing Safety	Trigger-Pull Weight		Weight of First Stage	
			factory adjusted	adjustable	factory adjusted	adjustable
5071 5072*	•	•	120 g - 4 ozs.	100-300 g 3.5-10.5 ozs.	55 g - 2 ozs.	50-100g 1.8-3.5 oz.
5073 5074*	•	•	350 g - 12.3 ozs.	200-700 g 7 ozs -1.5 lbs.	75 g - 2.6 ozs.	50-150 g 1.8-5.3 oz.
MATCH SINGLE STAGE TRIGGERS						
5075	•		The trigger pull weight is adjustable smoothly between 400 g. and 1.600 g. (= 14 ozs.-3.5 lbs.)			
5076*		•	and is adjusted in the factory to about 550 g (= 1.2 lbs.).			

*For Match Rifles of previous manufacture with rotary wing safety. Available as accessories.

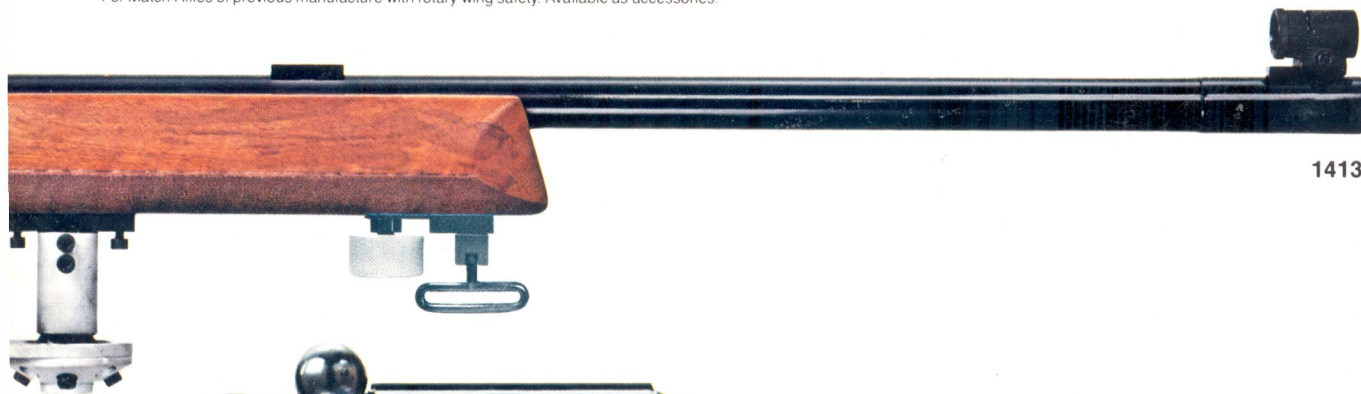

1413



Anschutz Match Triggers 5071-5075 are even faster, even more precise and reliable. The mechanism reaction time is reduced. All trigger adjustments are easily performed from outside without removing the stock.

Positioning Scale on top of receiver enables the shooter to position his sight quickly.

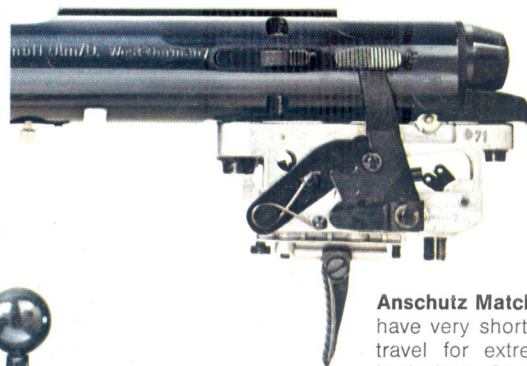
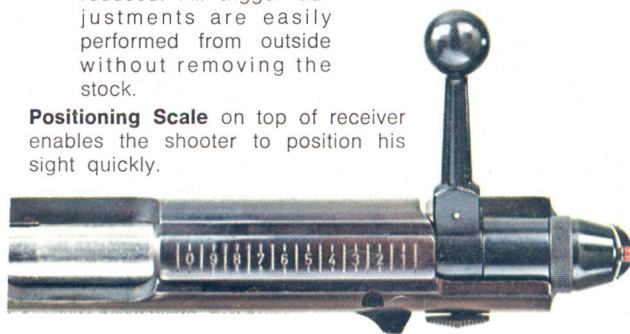

Anschutz Match 54 Bolts have very short firing pin travel for extremely fast lock time. Conveniently located, side safety.

Savage/Anschutz Target Rifles and Anschutz Match Air Rifle

Savage/Anschutz Model 64.

The 64 offers shooters a superior but moderately-priced, medium-weight entry into the world of international champions. Target stock has checkered pistol grip, contoured thumb groove, Wundhammer swell, I.S.U. style stock (similar to 1407) and adjustable butt plate with black-line spacer — allows you to adjust length of trigger pull to your own specifications. Three-pound single stage trigger is adjustable for weight of pull, take-up and over-travel. 64-S models are equipped with Anschutz 6723 Match Sight Set. 64 right-hand and 64-L are without sights. 64-S right-hand (with sights), 64-SL left-hand (with sights).

Savage/Anschutz Mark 12

Here's a target rifle with true target rifle features designed in the winning Anschutz tradition. The action is similar to that used in the Savage/Anschutz model 64. The heavy 7/8" diameter 26" long barrel is precision rifled. Other features the competitive shooter needs for the best possible scores include an authentic target rifle stock with cheek-piece, thumb groove and Wundhammer swell pistol grip; adjustable hand stop and sling swivel.

The Mark 12 comes fully equipped with front and rear target sights. The rear micrometer sight has click adjustments for windage and elevation. The globe front sight has seven aperture and post inserts for various shooting conditions and individual preferences.

Anschutz Model 250 Match Air Rifle. Caliber 177.

This superior match air rifle is known the world over for its accuracy. Wherever the match competition is stiffest you will find the Anschutz 250. Available on special order only. For further information contact your Savage dealer or write Savage Arms, Westfield, Massachusetts 01085.

Mark 12 Target Sling now available for your Savage/Anschutz target rifle. Made of genuine leather and fully adjustable. For either right- or left-hand use.



SPECIFICATIONS—FEATURES

	64	Mark 12
BARREL	Precision rifled. 22 long rifle only.	
Length	26", Medium heavy $1\frac{1}{16}$ " diameter.	26" $\frac{7}{8}$ " diameter
ACTION	Single shot. Large loading platform.	
TRIGGER	3 lbs. Single stage, adjustable for weight of pull, take-up, over-travel	Factory set for crisp trigger pull.
SAFETY	Slide safety locks sear and bolt.	Slide safety locks trigger.
STOCK	Walnut finished hardwood Cheek-piece Swivel rail.	Walnut finished hardwood.
SIGHTS	Receiver grooved for Anschütz sights. Scope blocks. Front sight base. 64-S models are equipped with Anschütz 6723 match sight set	Front—Insert type globesight. Rear—(Micrometer click adjustments)
LENGTH	44"	43"
WEIGHT (avg.)	7 $\frac{3}{4}$ lbs.	8 lbs.
Left hand rifles built to same specifications, except with left-hand stock, cast-off.		
RATE OF TWIST (RH) 1 turn in 16" for 22 LR.		

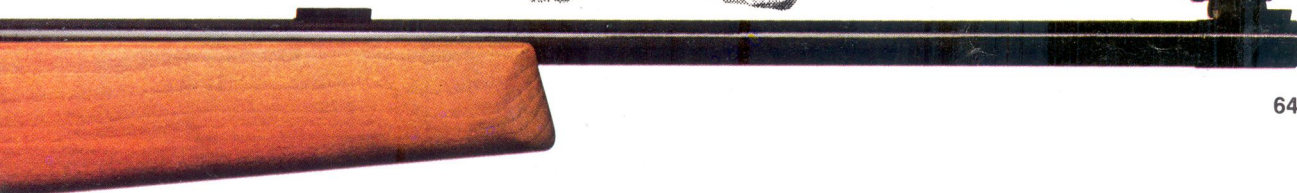

64

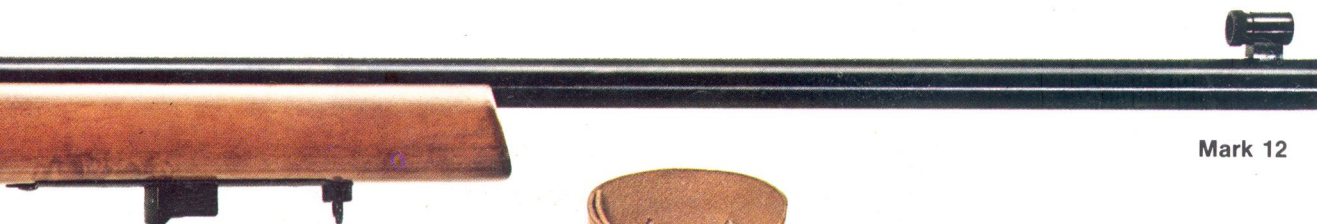

Mark 12

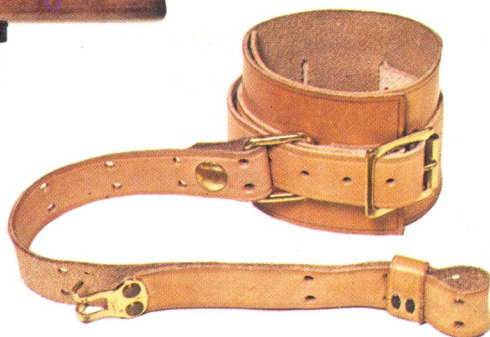

Mark 12 Target Sling

Anschutz Accessories and Parts

Should your dealer or gunsmith be out of stock, order direct from:
Mail Order Parts Division, Savage Arms, Westfield, Mass. 01085.



No. 6720 International Sight Set. Includes No. 6702 rear sight with 1.1 mm peep sight discs, No. 6522 front sight, rubber eyeshade, set of post and aperture inserts.

No. 6702 International Micrometer Sight. With scale. Precise 1/6 minute click adjustments for windage and elevation. Includes 1.1 mm peep sight disc. Slide-on base fits Anschutz receiver grooves.

Peep Sight Discs.
No. 6700-5B - 1.2 mm aperture.

No. 6723 Match Sight Set. Includes No. 6705 rear sight with 1.1 mm peep sight disc, rubber eyeshade. No. 6522 front sight and set of seven post and aperture inserts.

No. 6705 Match Micrometer Sight. With precise 1/6 minute click adjustments for windage and elevation. Includes 1.1 mm peep sight disc. Slide-on base fits Anschutz receiver grooves.

No. 6700-20 Rubber Eyeshade. Slips onto peep sight disc. Cut to length desired by removing one groove at a time.

No. 7800 Filter Set. Five in set - reduce haze or glare. Graduated density for varying light conditions. Fits rubber eyeshade, peep sight disc or adjustable eyepiece.

No. 6522-U14 Non-Misting Aperture Set. Eight sight inserts with ring diameters from 3.1 mm to 4.3 mm. Includes screw clamp, fitting all Anschutz globe front sights. Also, fits globe front sight of Feinwerkbau air rifle.

No. 6709 Base for Redfield Sight. Slides into grooves of Anschutz receiver. Provides side-rail base for Redfield International or Olympic sights.

No. 6713 Special High Sight Blocks. In some cases, necessary on the adjustable cheek-piece models (1413 and 1411).

No. 6522-1 Globe Front Sight. Inserts easily changed, quickly attached to front sight block.

No. 6522-5 Post Inserts. Set of five. Individually in 1.7, 2.0, 2.3, 2.6 and 3.4 mm widths.

No. 6522-9 Aperture Inserts. Set of 10. Individually, 2.7, 3.0, 3.2, 3.4, 3.6, 3.8, 4.0, 4.2, 4.4 and 4.6 mm.

No. 6530 Spirit Level. Fits into globe front sight. Enables shooter to correct his position before each shot.

No. 6525-6 Anti-Glare Tubes. Set of two. Slip into globe front sight.

No. 6772 Combination Adjustable Eyepiece/Adjustable Filter Set. Eyepiece has choice of eight apertures from 0.9 to 1.6. 1.1 mm Iris element included. Adjustable filters, choice of five settings.

No. 4920 Detachable Prone Butt Plate.** Usable with the 1973 right and left-hand 1407 and 1411 models. Each 4920 comes with adapter nut for earlier models.

No. 4921 Detachable Variable Angle Hook* Hook (usable for both right and left-hand) attaches to the new prone butt plate, No. 4920. It will not attach to old prone plate, No. 4717.

No. 4719S-U4 Base For Prone Butt Plate No. 4920. Must be substituted for present base on old model 1413 stocks to use the new prone butt plate.

No. 4745 Anschutz Weight. Weight, 1.1 lbs. Adjustable, slides in dovetail groove of swivel rail. Fits all target models.

No. 4746 Adjustable Barrel Weight with Spirit Level. Fits in groove of swivel rail of Anschutz models 1413, 1407, 1411 and Savage/Anschutz model 64.

No. 4770 Anschutz Bipod. Attaches to swivel rail of all Anschutz .22 target rifles, to support rifle in upright position (when resting on ground or table).

No. 4840 Palm Rest. Palm rest (usable for both right and left-hand shooters) is adjustable. Allows cant and rotates in complete arc. Lock setting.

No. 4734 Combination Hand Stop — Sling Swivel. For right-or left-hand use. Fastens to swivel rail and locks in position.

No. 7400-R Target Sling. Leather, with single frog, buckle and slide adjustment.
No. 7400-L. Left-hand model.

No. 6219 Adjustable Sling Swivel. New design. Easy to detach, but hold same setting.

Model 5071 Anschutz Match Two-Stage Trigger. Fits all side safety Match 54 target rifles. For trigger adjustments see Trigger Specifications page 23.

Model 5073 Anschutz Match Two-Stage Trigger (High Range). Fits all side safety Match 54 target rifles. For trigger adjustments see Trigger Specifications page 23.

Model 5075 Anschutz Single Stage Trigger. Fits all side safety Match 54 target rifles. For trigger adjustments see Trigger Specifications page 23.

Model 5072 Anschutz Match Two-Stage Trigger. For earlier Match 54 target rifles with wing type safety. For trigger adjustments see Trigger Specifications page 23.

Model 5074 Anschutz Match Two-Stage Trigger (High Range). Fits all earlier Match 54 target rifles with wing type safety. For trigger adjustments see Trigger Specifications page 23.

Model 5076 Anschutz Match Single Stage Trigger. For all earlier Match 54 target rifles with wing type safety. For trigger adjustments see Trigger Specifications page 23.

Stocks. Anschutz Match 54 target barreled actions can be used interchangeably in Model 1413, 1410, 1411, 1408 or 1407 type stocks. For information write Savage Arms, Service Department, Westfield, Mass. 01085

*Cannot be used on Savage/Anschutz Model 64. **Fits 1973 model 1413 also. However, it will not fit pre-1973 model 1413's. They will require new No. 4719S-U4 base in order to accept No. 4920 prone butt plate

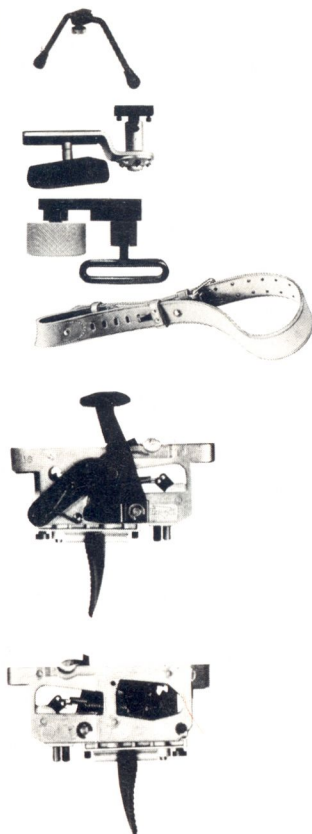

From **Savage**



Brassards

SAVAGE-STEVENS-FOX. Size 4", in 7 colors on black background. \$1.75 ea.

ANSCHUTZ. Size 3-5/8" x 2-1/8", in 3 colors on black background. \$.95 ea.

Belt Buckle

SAVAGE ARMS. Size 2-5/8", antique pewter finish. \$4.95 ea.

T-Shirt

SAVAGE 4-color Indian Head trademark (9 1/4" dia.)

50% Dacron polyester and 50% combed cotton. Red trim on neck and sleeves. Washable with instructions on label. \$4.95 ea. SIZES: Small (34-36)

Medium (38-40) Large (42-44) Extra Large (46-48)

Above prices include postage and handling. Sorry, no C.O.D. shipments.

Send your check or money order to:

Savage Arms/Dept. AP/Westfield, MA 01085

SAVAGE* FOUR-TENNER and the INDIAN HEAD*, STEVENS*, FOX are trademarks of Savage Arms Division, Emhart Industries, Inc. Westfield, Mass. 01085, U.S.A. Registered in U.S. Pat. & TM Office. *Marca Registrada, ANSCHUTZ, is a trademark of J. G. Anschutz GmbH, Ulm, West Germany, Registered in U.S. Patent Office.

For Retail Pricing:

For retail pricing information consult your local Savage dealer.

Specifications:

Specifications are subject to change without notice. Weights and stock dimensions vary slightly according to the individual firearm.

Stevens **SUPER VALUE** Sporting Firearms

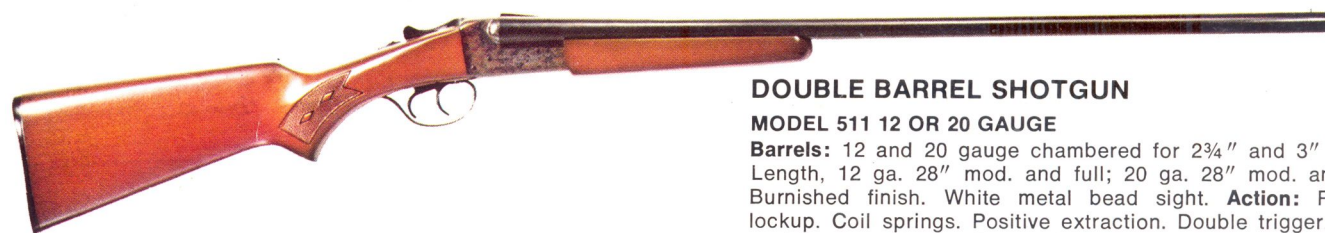

DOUBLE BARREL SHOTGUN

MODEL 511 12 OR 20 GAUGE

Barrels: 12 and 20 gauge chambered for 2 $\frac{3}{4}$ " and 3" shells. Length, 12 ga. 28" mod. and full; 20 ga. 28" mod. and full. Burnished finish. White metal bead sight. **Action:** Rugged lockup. Coil springs. Positive extraction. Double trigger. Automatic top tang safety. **Frame:** Color case hardened, permanently assembled. **Stock:** Walnut finished hardwood. **Length:** 43 $\frac{3}{4}$ "-45 $\frac{3}{4}$ ". **Weight:** About 7 $\frac{1}{2}$ -8 lbs. Lengths and chokes, 12 ga. 28" 30" mod. and full. 20 ga. 28" mod. and full.



BOLT ACTION SHOTGUN REPEATER

MODEL 58 410 GAUGE

Barrel: Chambered for all factory loaded 410 gauge 2 $\frac{1}{2}$ " or 3" shells. Length 24"; full choke. **Action:** Self-cocking bolt action. Bolt fitted with band type extractor. Thumb safety at rear of receiver. **Magazine:** Detachable clip; holds 3 shells. One in chamber makes gun a 4-shot repeater. **Stock:** Walnut finished hardwood. **Length:** 43 $\frac{1}{2}$ ". **Weight:** About 5 $\frac{1}{2}$ lbs.



INTERCHANGEABLE BARRELS FOR MODELS 79-VR AND FIELD GRADE 79. INTERCHANGEABLE WITHIN SAME GAUGE ONLY.

Chambered for 2¾" and 3" shells. Choose from a popular selection of barrel lengths and chokes.

Ventilated Rib

12 gauge: 28" Modified; 28" Full; 30" Full.
20 gauge: 26" Imp. Cyl.; 28" Modified; 28" Full.

Plain Barrel

12 gauge: 28" Modified; 28" Full; 30" Full.
20 gauge: 28" Modified; 28" Full.

Slug Barrel

12 gauge: 21" barrel, slug bore.

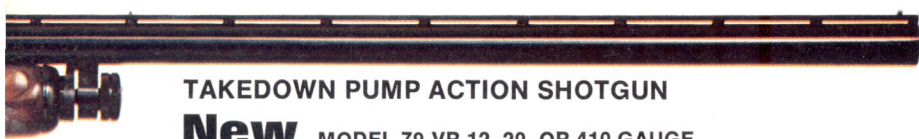
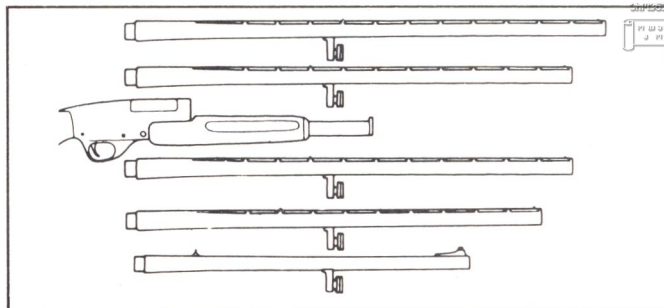

TAKEDOWN PUMP ACTION SHOTGUN

New MODEL 79-VR 12, 20, OR 410 GAUGE

Barrel: Ventilated rib. Chambered for 2¾" and 3" shells; 410 ga. for 2½" and 3". **Action:** Hammerless, takedown, side ejection, solid steel receiver. Top tang safety. Trigger must be released and pulled for each shot. **Magazine:** 4-shots plus one in chamber. One less for 3" shells. **Stock:** Walnut finished hardwood. Tapered slide handle. **Length:** 45½"-49½". **Weight:** about 6¼ - 7½ lbs. Lengths and chokes, 12 28" mod. or 30" full. 20 ga. 28" mod. or full. 410 ga. 26" full.

Interchangeable barrels available.

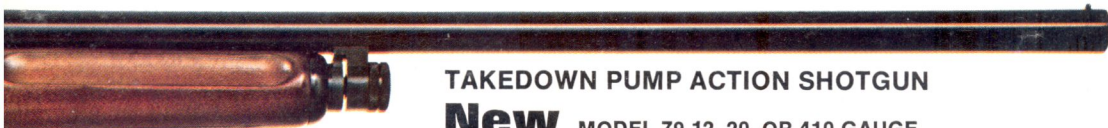
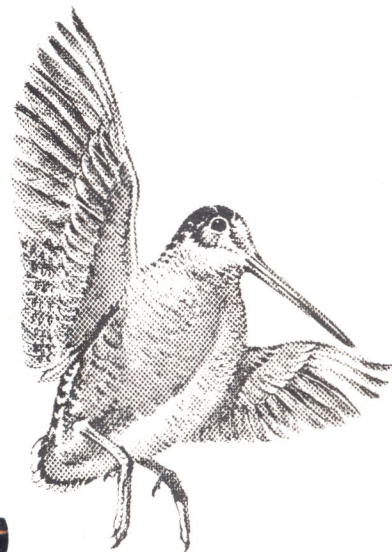

TAKEDOWN PUMP ACTION SHOTGUN

New MODEL 79 12, 20, OR 410 GAUGE

Barrel: Chambered for 2¾" and 3" shells; 410 ga. for 2½" and 3". **Action:** Hammerless, takedown, side ejection, solid steel receiver. Top tang safety. Trigger must be released and pulled for each shot. **Magazine:** 4-shots plus one in chamber. One less for 3" shells. **Stock:** Walnut finished hardwood. Tapered slide handle. **Length:** 45½"-49½". **Weight:** About 6¼ - 7½ lbs. Lengths and chokes, 12 28" mod. or 30" full. 20 ga. 28" mod. or full. 410 ga. 26" full.

Interchangeable barrels available.



SINGLE BARREL SHOTGUN

MODEL 9478 10, 12, 20 OR 410 GAUGES

Bottom opening lever - fullchoke

SINGLE BARREL SHOTGUN

MODEL 9478-Y (YOUTH) 20 OR 410 GAUGE

Bottom opening lever. For complete specifications on all 9478 models see pages 8-9.

Ask your dealer about these models

MORE Stevens SUPER VALUE Sporting Firearms

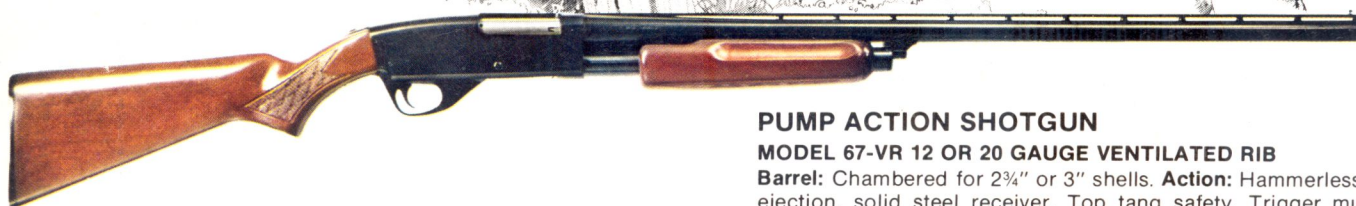
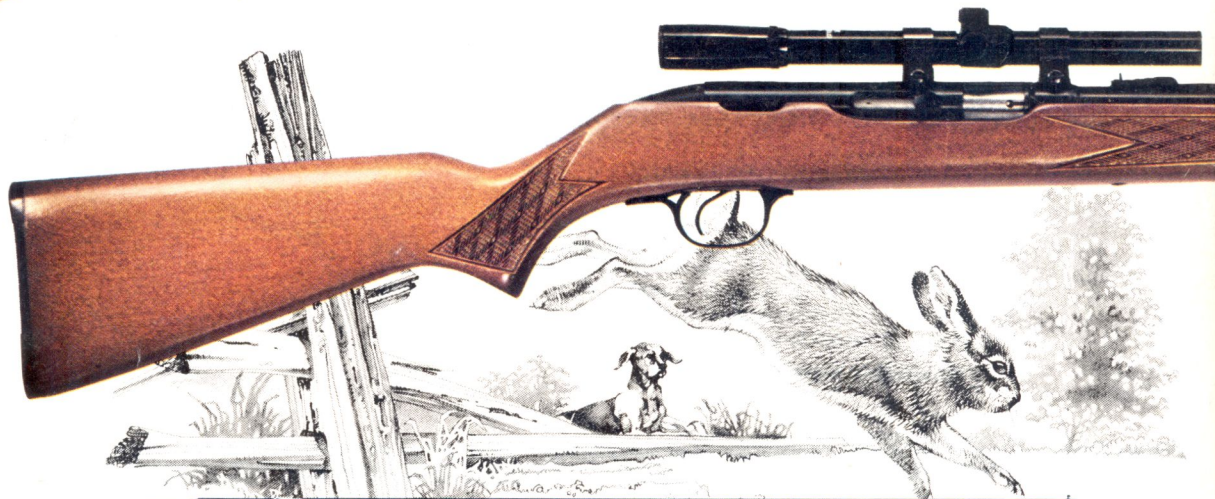

PUMP ACTION SHOTGUN

MODEL 67-VR 12 OR 20 GAUGE VENTILATED RIB

Barrel: Chambered for 2¾" or 3" shells. **Action:** Hammerless, side ejection, solid steel receiver. Top tang safety. Trigger must be released and pulled for each shot. **Magazine:** 4-shot plus one in chamber. One less for 3" shells. **Stock:** Walnut finished hardwood. Tapered slide handle. **Length:** 47½". **Weight:** 6¾ - 7 lbs. Lengths and chokes, 12 and 20 ga. 28" mod. or full.

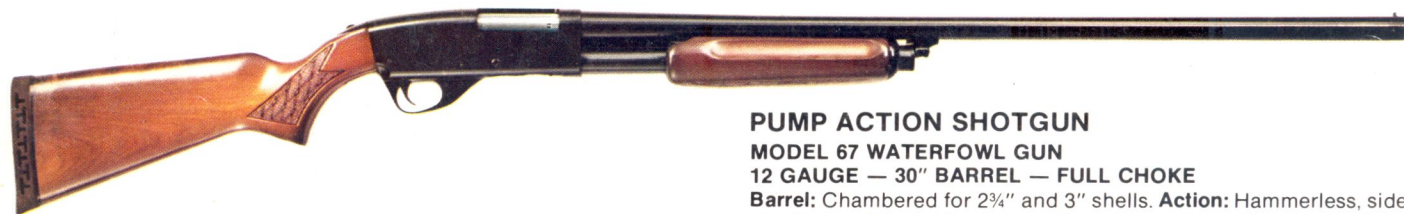

PUMP ACTION SHOTGUN

MODEL 67 WATERFOWL GUN

12 GAUGE — 30" BARREL — FULL CHOKE

Barrel: Chambered for 2¾" and 3" shells. **Action:** Hammerless, side ejection, solid steel receiver. Top tang safety. Trigger must be released and pulled for each shot. **Magazine:** 4 shots plus one in chamber; one less for 3" shells. **Stock:** Walnut finished hardwood. Tapered slide handle. Rubber recoil pad. **Length:** 49½". **Weight:** About 7½ lbs. Barrel length, 30"; choke, full.



PUMP ACTION SHOTGUN

MODEL 67 SLUG GUN 12 GAUGE

Barrel: 12 ga. chambered for 2¾" and 3" shells. **Length:** 21". **Action:** Hammerless, side ejection. Solid steel receiver. Trigger must be pulled and released for each shot. Top tang safety. **Magazine:** 4 shots plus one in chamber. One less for 3" shells. **Stock:** Walnut finished hardwood stock. Tapered slide handle. **Sights:** Ramp front and folding leaf rear. **Length:** 38½". **Weight:** About 6 lbs. Length and choke 21"; slug bore.



PUMP ACTION SHOTGUN

MODEL 67 12, 20 OR 410 GAUGE

Barrel: 12 and 20 ga. chambered for 2 $\frac{3}{4}$ " and 3" shells; 410 ga. for 2 $\frac{1}{2}$ " and 3". **Action:** Hammerless, side ejection, solid steel receiver. Top tang safety. Trigger must be released and pulled for each shot. **Magazine:** 4-shot plus one in chamber; one less for 3" shells or 410 ga. **Stock:** Walnut finished hardwood. Tapered slide handle. **Length:** 45 $\frac{1}{2}$ " - 47 $\frac{1}{2}$ ". **Weight:** About 6 $\frac{1}{4}$ - 7 $\frac{1}{4}$ lbs. Lengths and chokes, 12 ga. 28" mod. or full. 20 ga. 28" mod. or full. 410 ga. 26" full.



AUTOLOADING RIFLE WITH 4X SCOPE

MODEL 887-T — With 1541 4X scope and mount

AUTOLOADING RIFLE

MODEL 887 22 CALIBER

Barrel: Round, tapered with crowned muzzle. Chambered for 22 long rifle cartridges. Length 20". **Action:** Auto-loading with 22 long rifle only. Trigger must be pulled for each shot. Slide safety. **Magazine:** Tubular; holds 15 long rifle cartridges. **Stock:** One piece, walnut finished hardwood. **Sights:** Sporting front and rear sight with elevator. Receiver grooved for scope mounting. **Length:** 40". **Weight:** About 6 lbs.



CENTER FIRE RIFLE

MODEL 110-E BOLT ACTION

Barrel: Medium weight. Length, 22". Recessed bolt face, double locking lugs. **Magazine:** 4 shots plus 1 in chamber. **Stock:** Monte Carlo, checkered. **Length:** Overall, 42 $\frac{1}{2}$ ". **Weight:** 7 lbs. **Calibers:** Standard — 243, 30-06.



BOLT ACTION RIFLE

MODEL 246 22 CALIBER

Barrel: Round, tapered with crowned muzzle. Chambered for 22 short, long and long rifle cartridges. Length 20". **Action:** Streamlined, cocks on opening of the bolt. Thumb safety at rear of receiver. Double extractors for positive extraction and ejection. Recessed bolt face. **Magazine:** Tubular, holds 15 long rifle, 17 long, 22 short. **Stock:** Pistol grip. Walnut finished hardwood. **Sights:** Sporting front and rear sight with elevator. Receiver grooved for scope mounting. **Weight:** About 5 lbs. **Length:** Overall, 39".



SINGLE SHOT RIFLE

MODEL 120 22 CALIBER

Barrel: Crowned muzzle. Chambered for 22 short, long and long rifle cartridges. Length 24". **Action:** Hand cocked independent of bolt. Rebounding safety lock for added safety. **Stock:** One piece, walnut finished hardwood. **Sights:** Blade front and open rear sight with elevator. Receiver grooved for scope mounting. **Length:** 40". **Weight:** About 5 lbs.

Ask your dealer about these models

PREFERRED BY SPORTSMEN



Savage

SAVAGE ARMS DIVISION, EMHART INDUSTRIES, INC.
WESTFIELD, MASSACHUSETTS 01085

911 Printed in U.S.A.

An **EMHART** Unit

