

CAUCASUS JOURNAL OF SOCIAL SCIENCES



VOLUME 13

2020



POLITICS AND
INTERNATIONAL
RELATIONS

EDUCATION

HISTORY AND
ANTHROPOLOGY

LAW

HUMANITIES
AND ART

BUSINESS
AND ECONOMICS

PUBLIC HEALTH
AND PSYCHOLOGY

Caucasus Journal of Social Sciences

Volume 13
Issue 1

The University of Georgia Publishing House

Tbilisi

2020

UDC(uak) 908 (479) (06)

k144

Printed at The University of Georgia.

Tbilisi, Georgia.

Copyright © 2020. All rights reserved by the University of Georgia. Permission to make digital or hard copies of part or all of this work for personal or classroom use is granted without fee provided that copies are not made or distributed for profit or commercial advantage.

No responsibility for the views expressed by authors in the Caucasus Journal of Social Sciences is assumed by the editors or the publisher.

Caucasus Journal of Social Sciences

The University of Georgia.

Georgia, Tbilisi, 0175.

M. Kostava Street 77, Building IV.

Tel: (+995 32) 255 22 22

Email: cjss_editor@ug.edu.ge

Copyright © 2020

Caucasus Journal of Social Sciences

ISSN 1512-3677

Caucasus Journal of Social Sciences

Editors

Marc Daniel Lyn Carper

Ken Goff

Managing Editor

Julieta Andguladze

Abuladze Konstantine Tbilisi Teaching University “Gorgasali”
Alasania Giuli The University of Georgia
Begiashvili Malkhaz The University of Georgia
Bobokhidze Mariam The University of Georgia
Davies Janette Oxford University
Dzebisashvili Lasha The University of Georgia
Ghudushauri Tinatin The University of Georgia
Gvelesiani Mariam The University of Georgia
Ivaneishvili Baia
Kakachia Kornely Tbilisi State University
Kaladze Natia The University of Georgia
Kartozia Alexandre Tbilisi State University, the European University
Viadrina
Kazakhashvili Nata The University of Georgia
Licheli Vakhtang The University of Georgia
Meparishvili Marina The University of Georgia
Meshvelishvili Tea
Meskhishvili Nino
Michael John Vickers
Nadareishvili Mamuka Chachava Clinic
Nanobashvili Ketevan
Raupp Edward Stefano Moshi Memorial University College
Reisner Oliver The Humboldt University
Robakidze Maia
Sanadze Manana The University of Georgia
Söderlind Ulrica Stockholm University
Tsiskadze Mariam The University of Georgia
Tsitskishvili Rusudan
Waßmer Martin
Zedelashvili David

Caucasus Journal of Social Sciences
Volume 13, Issue 1, 2020
Contents

History

| | |
|--|----|
| <i>Berikashvili David</i> Silver Coins of Queen Rusudan from Samshvilde | 6 |
| <i>Alasania Giuli</i> The date of death of Tamar, the Georgian King of the kings | 26 |
| <i>Hamid Asad Pour, Masoud Vali Arab</i> The Georgian of Shushtar at the Safavid Era (10421144 AH) (16201722AD) | 46 |
| <i>Meshvelishvili Tea</i> Gurcistan Province Register Document as a source for research the History of Georgian and Ottoman Empire | 60 |

Law

| | |
|--|----|
| <i>Metreveli Archil</i> The freedom of personal self-determination as the prime principle for “The Religion or Belief Manifestation Test” in the ECHR Case-Law | 75 |
| <i>Mariam Skhulukhia</i> Online Dispute Resolution in Georgia: The Benefits and Challenges | 94 |

Health

| | |
|---|-----|
| <i>Elene Golovachova, Tinatin Mikadze, Manana Kalandadze</i> Association between oral habits, mouth breathing and malocclusion in Georgian preschoolers | 109 |
|---|-----|

Berikashvili David
The University of Georgia

Silver Coins of Queen Rusudan from Samshvilde

(Discovery of 2019)

On July 24, 2019, a pit burial was discovered near the ruins of Samshvilde Sioni Cathedral on the territory of the former settlement of Samshvilde (Kvemo Kartli region, South Georgia). Even though it was damaged by the occupation of the later periods, the artifacts uncovered there have helped determine the burial's chronology and cultural context.

Along with disarticulated human remains, a completely corroded iron ring, pottery fragments, ten well-preserved silver coins were discovered in the grave.

The present article is the first publication dedicated to this discovery. It provides information about preliminary results and brings the new numismatic finds into scientific circulation as new data for an understanding of the history of Samshvilde and medieval Georgia in general.¹

¹ The bio-archaeological remains, palynological and textile samples are under research and will be published in a separate article in 2022.

Sioni Cathedral is one of the most remarkable architectural monuments on the territory of former settlement Samshvilde. According to an old Georgian inscription ("Asomtavruli") on its eastern façade, it was built between 759 - 777 (Chubinashvili, 1969. 27).

It is not clear when precisely the Cathedral was ruined, but following the tradition, this should happen after an earthquake in the 10th century. This opinion is supported by the three-nave basilica of the 10th century, standing near Sioni Cathedral ruins and in the masonry of which yellowish sandstone blocks, characteristic of Sioni Cathedral, are re-used.



Figure 1. Samshvilde Sioni Cathedral. 2019. (Photo by D. Berikashvili)

In order to investigate these and other aspects, geophysical and archaeological works were planned and carried out around Sioni Cathedral in 2015-2016 (Berikashvili, Gabunia, Gagoshidze, Odilavadze, Ivanishvili & Lomidze. 2015. pp. 115-125). During these two years, 18 graves of the high medieval period were discovered to the

North and North-East of the Cathedral. Based on the artifacts, all they belong to Samshvilde citizens of middle and high social status (Berikashvili, Grigolia, Kvavadze, Miuller-Bieniek & Coupal. 2017. pp. 10-16).

As archaeological research on this part of Samshvilde indicates, it was a very active urban area of the city and was closely connected with the Cathedral. Moreover, after Sioni Cathedral was destroyed, this area continued to function as a cemetery, and a certain number of graves must have been located here during this period.

From this perspective, *Grave No.4*, discovered between archaeological trenches N8 and O8 to the north of Cathedral ruins (Fig. 1), had the most importance. The grave was located some 15 m. to the North from the Sioni ruins. Its depth reached 1.45 m from the present ground surface.



Figure 2. *Grave No. 4. Sioni Area. (Photo by D. Berikashvili)*

Based on the present data, it is hard to imagine the original construction of the grave, as it has been damaged by subsequent construction activity. For the same reason, it is difficult to determine the initial position of the deceased, but it can be concluded that

an important person was buried there in a Christian manner. However, the archaeological material discovered in the grave helps us to determine its chronological frames and cultural belonging.

Archaeological Finds

The corroded ring, a tall, an ovoid jug, a yellowish, middle-sized pot, and ten well-preserved silver coins were discovered in *Grave No. 4*.

It is noteworthy that the ring was placed on the finger of the deceased's right hand, and despite the skeletal damage, it was still fixed *in situ*. Due to the strong corrosion, it is difficult to determine the exact form of the ring, but based on the similar materials from different archaeological sites, it can be assumed that the ring had a simple, circular shape.



Figure 3. *Grave No. 4. Sioni Area. Samshvilde. (Photo by W. Gagné)*

Similar circular iron rings are well-known from the Sioni cemetery (Ramishvili., 1970, p. 125. Pl. XXVII.3), Zhinvali cemetery (Mindorashvili. 2015. Pl. VII. 4, 5.), Amidasturi cemetery (Lagiashvili. 2011. p. 94, Pl. XX. 225) and from burials at Goriskana and Gheliskari (Mindorashvili. 2015. Pl. VIII.3) in Eastern Georgia.

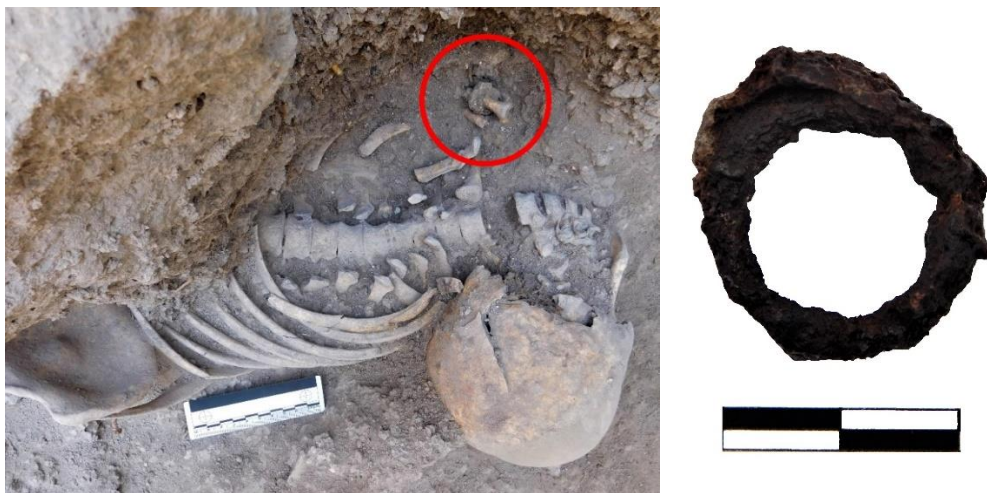

Figure 4. Corroded Iron Ring from the Grave No.4. (Photo by D. Berikashvili)

Alongside the ring, two pottery items were discovered in *Grave No.4*. The first is a clay pot with two handles, and another is a tall, ovoid jug with one handle.

The pot is 26 cm high, the diameter of the mouth is 21 cm, and the diameter of the flat base is 19.5 cm. The shoulders of the pot are decorated with horizontal combed lines, and there are two opposed handles (Fig. 5,1). This type of pottery is well-known from Dmanisi (Djaparidze., 1969. Pp. 57-76; Djaparidze., 1956; Kopaliani. 1996. Pl. XLVI. 1), Rustavi (Archvadze., 1969. pp.120-135; Chikoidze., 2007. P.3. Pl. XXI, 6,8), Sioni (Ramishvili. 1970) and Narli Dara (Mindorashvili. 2013, pp. 212-226; Tvalchrelidze, Bakhtadze and others. 2014. Pp.128-158) and other archaeological sites of 10th-13th centuries.



Figure 5. 1. The pot with two handles from Grave No. 4. Samshvilde Sioni Area. 12th-13th cc.
2. The ovoid Jug from Grave No. 4. Samshvilde Sioni Area. 12th-13th cc.
(Restorer by T. Tordia; Photo by D. Berikashvili)

The second pottery item from Grave No. 4 is a tall, ovoid jug with one handle. Its extant height is 36 cm. The diameter of the shoulders 23.5 cm and the diameter of the base is 12 cm. Even though some parts are missing, it was still possible to reconstruct its shape and determine the date. Based on similar materials from medieval archaeological sites such as Rustavi fortress (Chikoidze. 2007. 3. Pl. XXIII.8-10), Dmanisi fortress (Kopaliani. 1996), Kvetera (Mindorashvili. 2010, pp. 268-269, Pl. IX) and Zhinvali (Ramishvili. 1983; Bakhtadze. 2013, p.97, p. 119; p. 100. Pl. 122) Samshvlde jug also belongs to 11th to 13th centuries.

Based on the typology and chronology of the pottery, the date of the *Grave No 4* can be determined to be between the 11th and 13th centuries. Moreover, this date is supported by the numismatic finds from the same grave.

Numismatic Finds

During the excavation of *Grave No.4* ten silver coins were discovered. They were located on the right side of the body, between ribs and right arm. There were textile traces on some of the coins, which suggests that they were originally placed in a "Kisa" (a small wallet) that was placed in the grave. (Fig. 6).

Furthermore, it became clear that we are dealing here with well-preserved silver coins of Queen Rusudan (1223-1245) of Georgia with Georgian-Arabic inscriptions on the obverse and reverse and an image of Jesus Christ that makes their chronology indisputable. The coins differ in terms of their quality and minting, but their imagery is still identical²:

1: AR, D.: 25 mm: Wt.: 2.79 g (Pl. III.1)

Obverse: Frontal bust of Christ with nimbus. "IC XI" ["Jesus Christ"] to left and right. In the left hand ornamented book of Gospels. The cover is decorated with three relief beads. An "Asomtavruli" inscription surrounds the image
ՆՇԸՂԻԲՆԻԳՇՈԳՒՆԻԳՇԻՏԻԾՇԻՎԻ [in the name of God, was struck in the K'oronikon "un" (=1230)].

Reverse: the name Rusudan - ʃʊḥ ["RSN" – Rusudan] - within an ornamented frame. The whole surrounded by an Arabic inscription: ملكة الملكات جلال الدنيا والدين روسدان بنت تامار ظهير المسيح ("Queen of Queens; Glory of the World and Faith, Rusudan, Daughter of Tamar, Worshipper of the Messiah").

² A single description will account for all the coins. Minor variations are noted in the catalogue.



Figure 6. *The Coins from the Grave No 4. (Photo by D. Berikashvili)*



2: AR, D.: 26 mm; Wt.: 2.79 g (Pl. III.2). Obverse: As **1**. Heavily worn. Four relief beads. Reverse: As **1**. Arabic inscription slightly damaged.

3: AR, D.: 25 mm; Wt.: 2.83 g (Pl. III.3). Obverse: As **1**. Partly worn. Four relief beads. Reverse: As **1**.

4: AR, D.: 27 mm; Wt.: 2.62 g (Pl. III.4). Obverse: As **1**. Four (?) relief beads. IC XC ["Jesus Christ"]
Reverse: As **1**.

5: AR, D.: 28 mm; Wt.: 2.50 g (Pl. IV. 1). Obverse: As **1**. Three tips of a cross in nimbus. Four (?) relief beads. Reverse: As **1**.

6: AR, D.: 28 mm; Wt.: 2.72 g (Pl. IV. 2). Obverse: As **1**. Three tips of a cross in nimbus. Four relief beads. Reverse: As **1**.

7: AR, D.: 28 mm; Wt.: 2.60 g (Pl. IV. 3). Obverse: As **1**. IC XC ["Jesus Christ"]
Reverse: As **1**, except for the central frame decorated with four circles alternating with five- and six-pointed stars.

8: AR, D.: 27 mm; Wt.: 2.45 g (Pl. IV. 4). Obverse: As **1**. Four relief beads. Reverse: As **1**.

9: AR, D.: 27 mm; Wt.: 2.61 g (Pl. V. 1). Obverse: As **1**. Three tips of a cross in nimbus decorated with relief beads. Four relief beads on Bible. Reverse: Reverse: As **1**, but with a six-pointed star beneath Rusudan legend.

10: AR, D.: 25 mm; Wt.: 2.52 g (Pl. V. 2). Obverse: As **1**. IC XC ["Jesus Christ"].
Five relief beads on Bible. Reverse: As **1**, except for the central frame decorated with four circles alternating with five- and six-pointed stars.

Conclusions

As can be seen from the description of the coins, despite the slight differences, all of them represent silver dramas of Queen Rusudan.

It is well known that in the previous period in Georgia, as well as in the whole of the Middle East, so-called irregular-shaped copper coins were in use. The usage of copper alloy for minting the coins was associated with the so-called "Silver Crisis." However, from the beginning of the 13th century, when the "Crisis" ended, the minting of the regular shaped silver coins began in Georgia during Queen Rusudan's reign (Dundua, 2006. 223).

Although Rusudan's drama is one of the most impressive silver coins in Georgian numismatics, many questions remain unclear, particularly the place of its minting. The main reason why there is still no clear answer to this question is the fact that the geographical location of the mint is not indicated directly on the coins. In addition, no written sources provide information about the innovation initiated by Queen Rusudan. Therefore, it can be said that all opinions expressed today regarding this question remain at the level of assumptions.

Only a few attempts have been made to identify the geographical areas where Queen Rusudan's drama were minted. For example, Eugeny Pakhomov, a Russian historian and numismatist, believed that the minting of Rusudan's silver dramas began in Kutaisi, in Western Georgia, when Queen Rusudan migrated there after the invasion of Jalal-Ad-Din into Eastern Georgia (Pakhomov 1910. 109).

Unlike Pakhomov, David M. Lang, the Professor of Caucasian studies at the University of London supported the hypothesis that the mint of Rusudan's silver drama could be only in Tbilisi in 1230. This was the period when Tbilisi was liberated and reoccupied by Georgians again after a long time (Lang 1955. 31).

There is also a hypothesis proposed by Georgian numismatists Giorgi and Tedo Dundua, who conclude that Rusudan's drama were minted in "Tskhumi," present-day Sokhumi in Abkhazia. This idea is not, however, supported by archaeological evidence and therefore needs more support (Dundua, 1995.27-28; Dundua G., Dundua T. 2006. 269; Dundua T., Dundua G. 2015. 82).

Although the subject of the present article is not an in-depth investigation of the geographical area where Rusudan's silver drama were minted, we consider that the most realistic assumption is that of David M. Lang, who assumed Tbilisi to be the leading centre for the minting of these coins. Furthermore, the geographical area of distribution and discovery of Rusudan's drama, confined mainly to Eastern Georgia, also supports this hypothesis.

Another problematic issue related to Rusudan's silver dramas is that fact that almost in every case, their exact archaeological contexts are uncertain and coins are out of archaeological stratigraphy. One rare exception is the Zhinvali excavation, where five silver dramas were discovered by archaeologist Ramin Ramishvili in 1973 (Ramishvili., Jorbenadze., others...1981. Pp. 129-143; Rcheulishvili. 1983. P. 63). Another example comes from Ujarma Citadel, where Rusudan's four silver dramas were unearthed by the archaeologist Giorgi Lomtadze (Lomtadze., 1953. Pp. 11-12).

Two more discoveries are associated with Khandaki village (Central Georgia) and Dedoplistskaro (East Georgia). In Khandaki, numismatist David Kapanadze discovered a drama with a "unique obverse and reverse" in 1915. This discovery is discussed by the author in his work published in 1955 (Kapanadze., 1955. Pp. 70-71; Pl. VI; 1957. Pp.79-81). In addition, the discovery in Dedoplistskaro in 1989 also has high scientific value. The Dedoplistskaro coin hoard contains 60 coins, among which there are 38 silver dramas of Rusudan. The Dedoplistskaro hoard is carefully discussed by the numismatist Medea Tsotselia (Tsotselia, 2010. p.220).

In 2016 a summary of work on these issues appeared in a publication that combined all the known cases of Rusudan's silver drama coinage (Paghava., Spanderashvili et al. 2016). There are discussions of distribution areas, the minting location, memorability, circulation, countermarking and alloy composition. Of particular importance is alloy composition, as there is still a significant lacuna in this sphere of studies in Georgian numismatics. Exceptions to the rule are published in 1943 (Kapanadze., 1943) and 2013 (Paghava., Geradze. 2013), where the results of Georgian and Ildegizid Medieval coin alloys are represented. It must be mentioned that in present day numismatics only statistical, visual, iconographic and geographical data no longer meet the scientific challenges. We believe that alongside the traditional approaches, analyses based on physical-chemical, petrographic, archaeometric, spectral and other technical knowledge must be carried out when examining the new numismatic series.

In this regard, our article is no exception. Its main goal is to bring newly discovered, well-documented numismatic material into scientific circulation and any interested parties. As for complex studies, this direction is still theoretical and as already mentioned, a separate article will be dedicated to these issues.

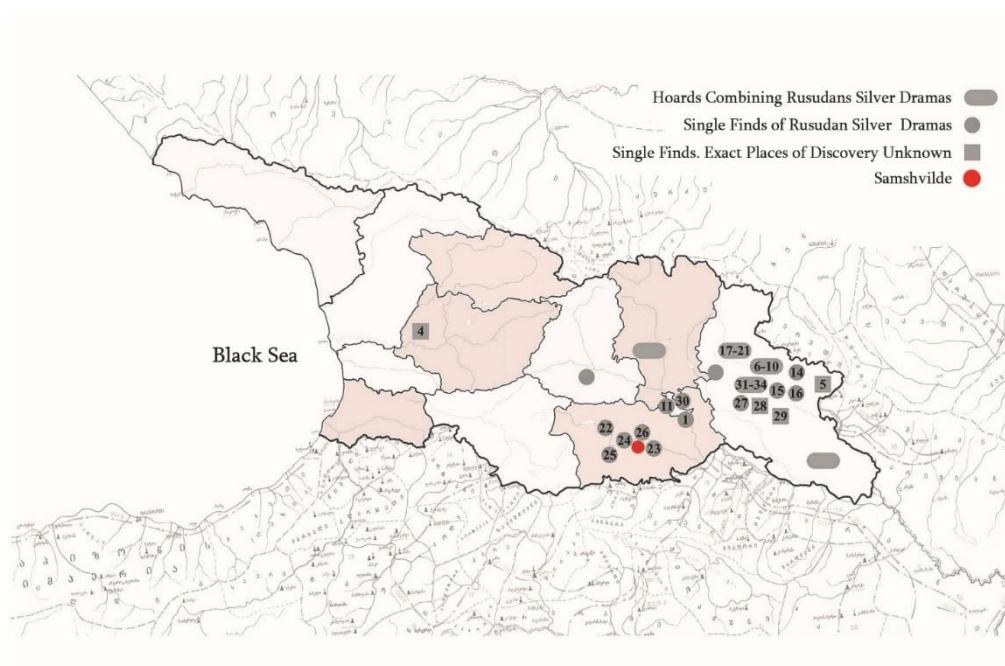
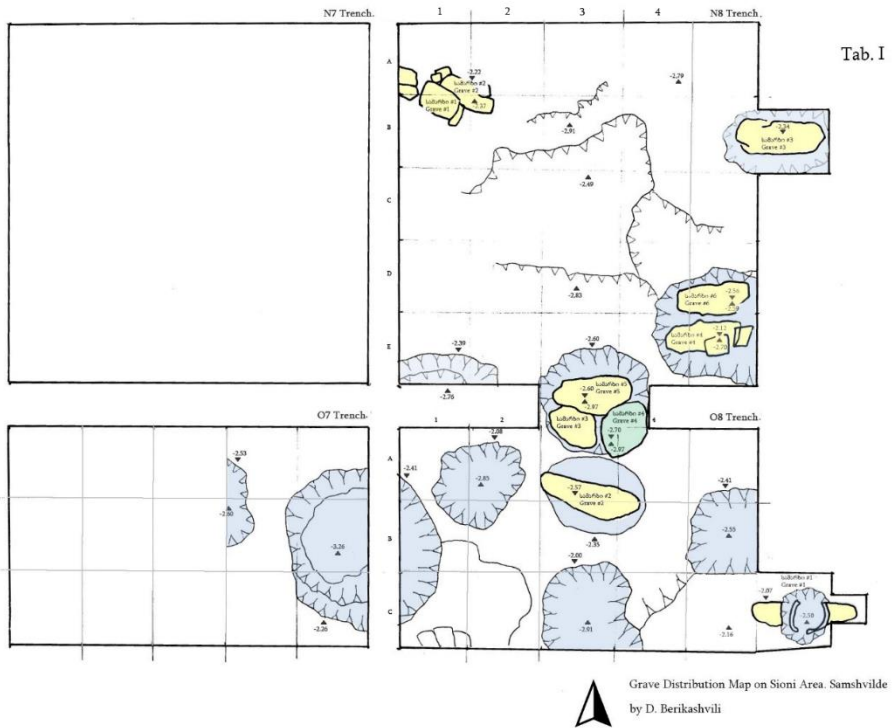

Figure 7. *The locations where silver coins of Rusudan were discovered:*

1. Tbilisi surroundings; 4. West Georgia. Exact location unknown; 5. Kakheti; 6-10. Telavi surroundings. "Telavi Hoard"; 11. Tbilisi. The gorge of Riv. Mtkvari; 14. Akhalsopeli, Kakheti; 15-16. Kvareli, Kakheti; 17-21. Akhmeta Region (?), Kakheti; 22-25. Kvemo Kartli; 26. Village Arakhlo. Bolnisi Region; 27. Manavi Castle surroundings; 28. Exact location unknown. Kakheti Region; 29. Kakheti Region; 30. Tbilisi surroundings. 31-34. "Manavi Hoard". Manavi Castle surroundings³.

³ *The map of discoveries of Queen Rusudan's silver dramas (Material for the Corpus, Minting Location, Memorability, Circulation, Countermarking, Alloy Composition) by: Irakli Paghava, Roland Spanderashvili, Giorgi Gogava, Davit Mikeladze, Evgeni Chanishvili, Teimuraz Gabriadze. 2016. Tbilisi. The exact origin of some dramas are*

Tables



uncertain. For this reason these areas are not shown on the map. We express our gratitude to the all authors for sharing this map.

Tab. II

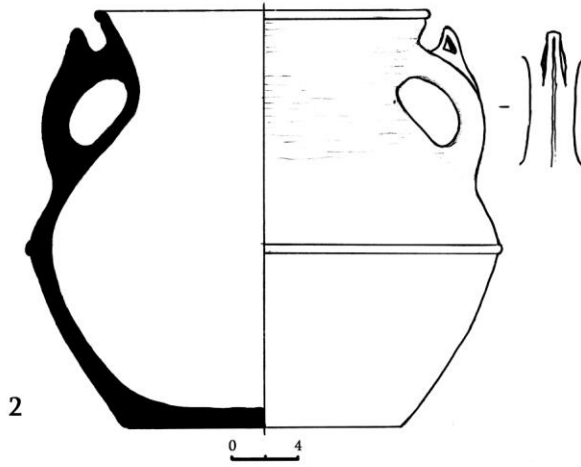
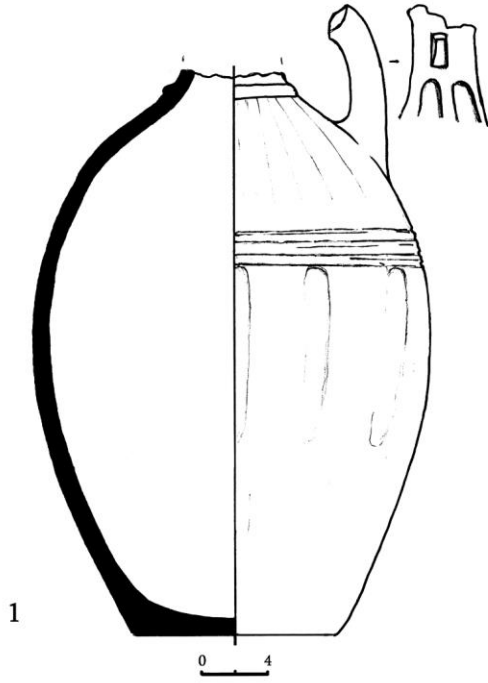

Tab. III



Tab.IV



Tab. V



References

- Archvadze, T. 1969. For the History of Pottery Production in Medieval Georgia. FSAD. Vol. II. Tbilisi. Pg. 120-135. (In Georgian).
- Bakhtadze, N. 2013. Ceramics in Medieval Georgia. Tbilisi. (in Georgian with English Summary)
- Berikashvili, D; Gabunia, T., Gagoshidze, G., Odilavadze, D., Ivanishvili, Ir., Lomidze V. The Scientific Results of Samshvilde Archaeological Expedition of the University of Georgia in 2015. Tbilisi. 2015. Pg. 115-125. (In Georgian).
- Berikashvili, D., Gabunia, T., Gagoshidze, G., Odilavadze, D., Bukhsianidze, M., Grigolia, G. 2015. The Results of Samshvilde Archaeological Expedition of the University of Georgia. Tbilisi. 2015. Pg. 115-125. (in Georgian).
- Berikashvili, D., Bukhsianidze, M., Kvavadze, E., Bitadze, L., Gabunia, T. 2016. The Results of Samshvilde Archaeological Expedition of the University of Georgia. Tbilisi. 2016. Pg. 12-13. (in Georgian).
- Berikashvili, D., Grigolia G., Kvavadze El., Miuller-Bieniek, A., Coupal Is. 2017. The Results of Samshvilde Archaeological Expedition of the University of Georgia in 2017. Pg. 10-16. (In Georgian)
- Berikashvili, D., Pataridze M. 2019. Samshvilde Hoard. Tbilisi. (in Georgian with English Summary)
- Chikoidze Ts. 2007. The Habit and the Culture of the Ordinary Population of Rustavi. Archaeological Sites of Medieval Georgia. I. Tbilisi. Pg. 3. XXI. 6,8.
- Chubinashvili, N. 1969. Samshvilde Sioni. Tbilisi. (in Russian).
- Djaparidze V. 1956. Georgian Ceramics. (X-XIII cc.). Tbilisi. (in Georgian)
- Dundua G., Dundua T. 2006. Georgian Numismatics. Artanuji I. Tbilisi. Pg.223-225. (in Georgian).
- Dundua T. 1995. West and East according to Numismatical Materials. Tbilisi. Pg. 27-28. (in Georgian).
- Dundua T., Dundua G. 2015. Catalogue of Georgian Numismatic. Part 3. Pg. 82. Tbilisi. (in Georgian).

Djaparidze V. 1969. The short results of Dmanisi Archaeological Expedition of 1965-1966. SSMAE. Vol.I. pg.57-76. Tbilisi. (in Georgian).

Gagoshidze, G., Chantladze N. 2009. Monophisite Monuments in Georgia. I. Kvemo Kartli. Tbilisi (in Georgian with English Summary).

Kapanadze, D. 1943. The Composition of Georgian Coins. Moambe of the Academy of Science of Georgia. Vol. IV. №6. Tbilisi. (in Georgian).

Kapanadze, D. 1955. Georgian Numismatics. Moscow. (in Russian).

Kapanadze, D. 1957. The Family Sign of Bagrationi on Georgian Medieval Coins. Numismatic Digest. GIM. Vol. 26. Part 2. Moscow. (in Russian).

Kopaliani J. 1996. Dmanisi Tsikhe. Tbilisi. (in Georgian)

Lang D. 1955. The reoccupation of Tiflis by Rusudan in 1230 is marked by the resumption of silver minting after the lapse of over a century. Studies in the Numismatic History of Georgia in Transcaucasia. New York.

Lagiashvili, G. 2011. Archaeological Excavationsn at "Amidasturi" St. George's Church. Tbilisi. Pg. 94. Tab. XX. 225. (In Georgian)

Lomtadze, G. 1953. The Results of Ujarma Archaeological Excavations. Scientific report dedicated to archaeological studies in 1952. Tbilisi. pp.11-12. (in Georgian).

Mindorashvili, D. 2015. Archaeology of Georgia II-III. Batumi. Tab.I. 28-31. (In Georgian).

Mindorashvili, D. 2013. Narli Dara Former Settlement. Moambe of the Georgian National Museum. Vol. IV. Tbilisi. Pg. 212-226. (In Georgian).

Mindorashvili, D. 2010. Archaeological Materials of Kvetera Fortress. Tbilisi. Pg. 268-269 (in Georgian with English summery).

Muskhelishvili, L. 1943. Samshvilde Sioni Inscription and Building Data. MOAMBE. XIII. Tbilisi. (in Georgian). Pg. 97.

Paghava, Ir., Geradze, G. 2013. The Alloy Composition of the Georgian and Ildegizid Coins of the 12th-13th Century. Pro Georgia, 23. Tbilisi

Paghava I., Spanderashvili R., Gogava G., Mikeladze D., Chanishvili Ev., Gabriadze T. 2016. Silver Coinage Emission by Queen Rusudan (Material for the Corpus, Minting Location, Memorability, Circulation, Countermarking, Alloy Composition). Historical digest. Vol.1. Tbilisi. pg.206-258. (in Georgian with English Summary)

Pakhomov Ev. 1910. Georgian Coins. Part I. St. Petersburg. (in Russian).

Pakhomov Ev. 1970. Georgian Coins. The hoards of Coins of Azerbaidjan and other Republics of Caucasus. Vol.I-IX. Baku. (in Russian).

Ramishvili, R. 1970. Sioni. Archaeological Sites of Iori river Gorge I. Tbilisi. (In Georgian).

Ramishvili, R. 1983. Archaeological Investigation in Aragvi Gorge. Tbilisi. (In Georgian).

Ramishvili R., Jorbenadze B., Gogelia D., Ghloni M., Chikhladze V., Robakidze Ts., Margvelashvili M., Muxigulashvili N., Rcheulishvili G., Tsiklauri J., Loidze Ts., Kalandadze Z., Tsiklauri I., Tsereteli K. 1981. Archaeological studies of Aragvi Gorge. PAI. 1978. Tbilisi. (in Russian). pp. 129-143.

Rcheulishvili R. 1983. Excavations of former settlement Zhinvali. AO-1981. Tbilisi. Pg-63. (in Russian).

Tvalchrelidze, Z., Bakhtadze, N., Chkhvimiani, J., Meshveliani, T. 2014. The Unknown Type of Medieval Living House from Kvemo Kartli. Moambe of the Georgian National Museum. Vol. V.(50-B). pg. 128-158. Tbilisi. (in Georgian with English Summary).

Tsotselia, M. 2010. Coin Finds in Georgia (6th Century BC – 15th Century AD) Wetteren.

Plates

Pl. I. Grave distribution map on Sioni Area. Samshvilde.

Pl. II. The pottery discovered in Grave No. 4. Sioni Area. Samshvilde.

Pl. III-V. Silver Coins of Queen Rusudan of 13th century Grave №4. Sioni Area. Samshvilde.

Giuli Alasania
The University of Georgia

The date of death of Tamar, the Georgian King of the kings

Recent publications about the death of Tamar, the King of the Kings, (M. Kadagidze, 2001; G. Abdaladze, 2006; Ts. Ghvaberidze, 2009; Sh. Darchiashvili, 2010; M. Bakhtadze, 2011; T. Kenkebashvili, 2011; G. Japaridze, 2012; M. Pataridze, I. Paghava, 2013) have again raised a question which seems to be unsolvable.

Keywords: King Tamar, Georgia, History

In 1966, B. Silagadze placed the death of Tamar in 1207 based on the data of Ibn al-Athir (Silagadze, 1966)⁴. In the same year, S. Kakabadze agreed with this date⁵ (Kakabadze, 1966). A 1974 article by T. Natroshvili and G. Japaridze put the death of Tamar in 1210. The work of J. Odisheli followed this (Natroshvili, Japaridze, 1976),⁶ also in 1974, which considered all earlier published research and sources, including numismatic material, and put the date as 1207. In 1975 Sh. Darchiashvili agreed with 1210 (Darchiashvili, 1975)⁷ based on brief Armenian inscriptions, which were outlined in his research published in 2010 (Darchiashvili, 2010)⁸. Research by G. Otkhmezuri (Otkhmezuri, 1981)⁹ was published in 1981 in which the scholar, using a different interpretation of the Gunia-Qala inscription, renders groundless the information of the first chronicler of Tamar as if Tamar granted the titles of Atabeg and Amirspasalar to Ivane Mkhargrdzeli simultaneously. Due to this fact, some researchers consider the year of the death of Zakaria Mkhargrdzeli (1212) or the next year (1213) as

⁴ Silagadze, B. (1966). XIXIII ss. saqarTvelos istoriis zogierTi sakiTxi ibn al-asiris cnobaTa Suqze.

krebulSi saqarTvelo rusTavelis xanaSi [*Some Issues of the History of Georgia of the 12-13th cc. in the Light of the Data of Ibn al-Asir, Georgia in the Epoch of Rustaveli*]. Tbilisi: Metsniereba.

⁵ Kakabadze, S. (1966). shota rustveli da misi vepkhist'qaosani [Rustaveli and his Work *The Knight in the Panther's Skin*]. pp. 228-230.

⁶ Natroshvili, T. Japaridze, G. (1976). kartuli ist'oriuli kronologiis erti sak'itkhi [One Issue of Georgian Chronology], *Tsiskari*, 1.

⁷ Darchiashvili, Sh. (1975). XIII sauk'unis dasats'qisis sakartvelos kronologiis sak'itkhisatvis. ["For the Issue of the Chronology of Georgia of the early 13th century"] *Mnatobi*, 2, p. 151.

⁸ Darchiashvili, Sh. (2010). dziebani kartul-somkhuri urtiertobebis ist'oriidan. [Searches from the History of Georgian-Armenian Relations], somkhuri lap'idaruli ts'arts'erebi [Data of Armenian Lapidary Inscriptions about Georgia in the 12th c. – 1st third of the 13th century], Tbilisi, Artanuji.

⁹ Otkhmezuri, G. (1981). XII-XIII sauk'uneebis mijnis kartuli lap'idaruli ts'arts'erebi rogor ts'art'orio ts'qaro [Georgian Lapidary Inscriptions of the turn of the 12th-13th centuries, as a historic source], Tbilisi, 1981.

the date of the death of Tamar (Brosset,1886)¹⁰. However, 1216 (Kekelidze, 1941)¹¹ and 1215 (Kenkebashvili, 2011) ¹² are also suggested in scholarly literature. According to G. Otkhmezuri, Vache is named as the "msakhurtukhutsesi" [master of servants] in the list of the inscription instead of Ivane. According to the scholar, this means that in the year of Tamar's death, which he assumes was 1207, Vache was the holder of this title while Ivane was the Atabeg by that time¹³. In the research of the second edition of the Russian translation of the so-called second chronicler of Tamar, Mamisa Berdznishvili agrees with the date of 1207¹⁴.

Many of the researchers listed earlier place the death of Tamar in 1207 or 1210; however, the sources remain almost the same in both cases. Different conclusions come from different interpretations of the same sources.

For dating the death of Tamar as happening in 1210, numismatic data is decisive. The "Silver Crisis" existing in the Middle East from the 11th century occurred in Georgia, too, demonstrated by the minting of copper coins. Those copper coins were proclaimed as silver coins. That significant financial reform in Georgia was

⁸ Brosset, M. (1886). *L'Histoire de la Georgie. Additions et éclaircissements*. 298 (1212); P. Ingorokva, a collection of writings, 1, 1963, 143, chronicles and other materials of Georgian history and literature, collected, chronologically arranged and explained by T. Zhordania, 1, Tbilisi, p. 1892, p. 300 (1213); Janashvili, M. (1917). *Queen Tamar*, Tbilisi (However it is mentioned that this date is disputable), p. 74; Lolashvili, I. (1984). *Mravalkaredi*, Tbilisi, 116; Metreveli, R. (1965). *davit IV aghmashenebeli [David IV the Builder]*, I. Javakhishvili, *kartveli eris ist'oria [History of the Georgian Nation]*, 2, pp. 290, 385; Sanadze, M. Beradze, T. (2015). *shesavali sakartvelos ist'oriashi [Introduction to the History of Georgia]*, Tbilisi, p. 156.

⁹ Kekelidze, K. (1941). *ist'oriani da azmani sharavandedtani [The Histories and Eulogies of the Sovereigns]*, attempt to recover the text, Tbilisi, , p. 40.

¹⁰ T. Kenkebashvili. *Chronological Paradigms, Essays from the chronology of the history of Georgia of the 13th century*, Tbilisi, 2011, p. 42.

¹³ G. Otkhmezuri, "Georgian Lapidary Inscriptions of the turn of the 12th-13th centuries, as a historic source", Tbilisi, 1981, pp 20-32.

¹⁴ *Life of the Queen of Queens Tamar*, translation and introduction by V. D. Dondua, research and comments by M. M. Berdzenishvili, Tbilis (Russian), 1985, p. 62.

carried out in the times of David IV. Fair as well as unfair copper coins were minted. The "Silver Crisis" in Georgia lasted until the reform carried out during the reign of Rusudan, when in 1230, silver coins were issued.¹⁵

During the reign of Tamar, fair and unfair copper coins were minted. During her co-rule with King Giorgi (1179-1184), a coin on which the date is not indicated was minted. It mentioned "King of the Kings Giorgi" and "the King and Queen Tamar." Identification of the coin in the literature is different.¹⁶

According to k'horonikon 407 (11870), King Tamar minted her own coin. The coin is unfair. Some coins of this type 430 (1210) are printed without a change their design. The coins have the same mintage

The observations of the famous scholar E. Pakhomov should be taken into consideration concerning this issue. According to his research, noting a new date was usual in Muslim countries, although there was a changing of mintage.¹⁷ It is noteworthy that k'oronikon 407 (1187) of King Tamar and the coin's design issued in 430(1210) is unchanged. This rule was evidently reflected on the numismatic monuments of Tamar's epoch: of 1774 of King Giorgi III¹⁸, of 1187 and later of 1200 of King Tamar, on the coin of "Javachruler" of Lasha Giorgi (The date is not indicated on the coin. Presumably it was minted in 1205-7), later on the coin of 1210, 1227 of King Rusudan and later on the coins minted in 1230. These coins were of different types according to the dates ¹⁹. The dates on the coins do not indicate the time of the coronation of the king. This event has to be connected to the political-economic changes in the country. The dates

¹⁵ D. Kapanadze. Georgian Numismatics, Tbilisi, 1950, pp. 48.

¹⁶ D. Kapanadze connected the inscription with the Tamar's father 9 D. Kapanadze. Georgian Numismatics, p. 48-49), E. Pakhomov with her first husband (E. A. Пахомов. Монеты Грузии, Тбилиси, 1970,89).

¹⁷ E. A. Pakhomov. Coins of Georgia, Tbilisi, 1970 (Russian), 85.

¹⁸ It is the first case in the Georgian numismatique of indicating of the date by the Georgian k'oronikon 394 (1174). This means the time of minting of coin.

¹⁹ D. Kapanadze. Georgian Numismatics, Tbilisi, 1969,69-86.

mentioned above show the date of the coin type and not minting and issuing date.

During the reign of Giorgi III, a fair coin appeared with the year 1774 is printed on it again for the first time after the 10th century. Parallel samples of such fair and unfair coins are also found during the reign of Tamar and Giorgi Lasha. The majority of researchers believe that coins were minted in the name of Tamar during her reign several times: a biased and dateless coin which together with Tamar bears the name of Giorgi and its identification is different in the literature, a widely-used biased coin which bears the date UZ (407=1187), and precisely the same coins with a different date UL (430=1210); and a fair coin issued in 1200.

The dating of Tamar's coin to the year 1210 was questioned by Sargis Kakabadze, who was the first to place the death of Tamar in the year 1207. Others adhered to this version later. Some time ago, Ts. Ghvaberidze studied these coins. In her opinion, "k'oronikon 430 = 1210 ... is a mechanical error made on the same mintage. In particular, this date 407 arose based on the resemblance of the graphic outline of letters- z z- z and l - l. It is known that in the "Asomtavruli" alphabet the only difference between "ზ" ("Zen") and "ლ" ("Las") is a small vertical line coming down on the left side."²⁰ The researcher makes this assumption based on one more argument that the version of the above-mentioned coin type (of Tamar, dated 1210 [3758, 4175] is saved in the depositories of the National Museum of Georgia. On the backside of the coin, 583 AH is written, which corresponds to k'oronikon 407, i.e. 1187.²¹ Ts. Ghvaberidze supports her assertion by another observation that "the approved coin type was minted with the same date during the entire reign of this or that Georgian king. This happened during the reign of Giorgi III, Tamar, Giorgi Lasha and Rusudan.

²⁰ Ts. Ghvaberidze. When did King Tamar pass away? - Works of the Institute of History and Ethnology, 2009, p. 99

²¹ Ts. Ghvaberidze. When did King Tamar pass away? p. 98.

It seems that this was a rule established by the Royal Household of Georgia. It was undoubtedly in force during the minting of Tamar's coin dated k'oronikon 407 = 1187 as well"²².

Attention should be paid to another opinion of Ts. Ghvaberidze regarding the fair coin dated by k'oronikon 420 (= 1200) on which apart from Tamar, her spouse David is mentioned (David is not mentioned by the royal title). "The above coin was minted until the end of Tamar's rule bearing this date,"²³ i.e. 1200. The author discusses the situation in the Near East where the so-called "silver crisis" ended from the 1190s and the issue of high pureness and weight (2.8-2.9 g) dirham began and according to him, "the monetary reform carried out in 1200 CE was a political-economic measure relevant to that period in Georgia ..."²⁴ According to Ts. Ghvaberidze, this reform "for certain reasons (unfortunately these "certain reasons" are not specified – G. Alasania) was hindered as a result of emission of coins of the wrong form of Giorgi Lasha (1210) and Jalal Ad-Din (1226), but Queen Rusudan resumed this change by the monetary reform carried out in 1227." According to the researcher, "Queen Tamar could not have resumed the type of coins established in 1187 -- coins of wrong minting -- two decades later without any changes."²⁵

The numismatic data will be reviewed again later. Now, we will remember that in some cases a mistake was made in the inscription of coins. For example, the fair coin minted by Rusudan in 1227 is found with a different dating as well: in k'oronikon the second letter is inverted and in the date instead of "Dvk" (koronikon 447) there is Dvk 1217 – (koronikon 437) when Lasha Giorgi was on the throne.²⁶ Another mistake made by craftsmen is known when the legend about Tamar (the same as on Tamar coins of 1187) is inscribed on the reverse

²² Ts. Ghvaberidze. When did King Tamar pass away? p. 99.

²³ Ts. Ghvaberidze. When did King Tamar pass away? p. 99.

²⁴ Ts. Ghvaberidze. When did King Tamar pass away? p. 100.

²⁵ Ts. Ghvaberidze. When did King Tamar pass away? p. 100.

²⁶ D. Kapanadze. Georgian Numismatics, Tbilisi, 1950, 53.

of the coin dated by 1210 CE (k'oronikon 430) and the reverse of Lasha Giorgi's coin issued in 1210 is inscribed on the reverse²⁷ In the opinion of G. Abdaladze, it seems then both coins were minted in the State Mint in 1210 CE and the craftsmen confused with mintages.²⁸

It is essential to set the date of seizure of Kars, the death of David Soslan, and his campaign to Iran too set the date of the death of Tamar more accurately. There is a variety of opinions in literature about this. All Georgian sources do not mention all these facts. Considering all sources, it appears that these facts happened during the life of Tamar. The seizure of Kars is omitted by the so-called first historian of Tamar, while after the death of David Soslan an attack on the city of Ani under Sultan of Ardabil is described. This was followed by a Georgian attack on Ardabil and afterward on other Iranian cities: "They came to Marand ... city of Tavrezh ... Miana ... Zangan ... city of Khuarasan and Kazmini ... and approached the internal Romgur which is Khuarasan ... and send precious stones to the King herself, sun and sun of the suns ... The King became joyful."²⁹ The so-called second historian of Tamar narrates only about the seizure of Kars "on the 23rd or 24th year of her rule."³⁰

The chronicler of the period of Lasha-Giorgi also places these facts within the period of Tamar. However, unlike the first historian of Tamar, the story of the seizure of Kars by Georgians is told here. It is followed by information about the death of David Soslan, after which, according to the source, "they destroyed the cities of Persia and ruined Marandi and the country of Eran. They went so far

²⁷ D. Kapanadze, *The Georgian numismatics*, Tbilisi, 1969, pp. 78,81.

²⁸ G. Abdaladze. *Once Again about the Date of the Death of King Tamar*, a collection of scientific works, collection of scientific works of the Sighnaghi (Kakheti) branch of TSU, V Sighnaghi, 2004, 12.

²⁹ *Kartlis tskhovreba* ("The Old Georgian Chronicles"), prepared for publication, foreword and glossary by Ilia Antelava and Nodar Shoshiashvili, "Nike" Publishing House, Tbilisi, pp. 372-378.

³⁰ *Kartlis tskhovreba* (1996), p.405; *KARTLIS TSKHOVREBA*,(2008), 508. .

that the names of Georgians were not heard". The same chronicler returns to these facts in the period of Lasha Giorgi, son of Tamar, and wrote: "Their parent (i.e., the parent of Giorgi Lasha – G. Alasania), the Great King of Kings Tamar made them (Zakaria Mkhargrdzeli - G. Alasania) conduct a campaign and seize Kars, then conducted a campaign, went and entered the Great Persia, ruined Ardaveli, destroyed cities and fortresses and filled the kingdom with plunder."³¹

The information about the seizure of Kars dated 1199 CE provided by Vakhushti Bagrationi is clearly based on information received from the so-called second historian of Tamar. However, "23rd" is omitted there, and only "24th" is left. Then the death of Soslan, dated 1199, the facts of Ani and Ardaveli are mentioned, which are followed by the campaign of Zakaria into Iran and finally, the death of Tamar in 1201³². Because all the events listed here are not dated in the sources or are dated differently, attempts to set the dates of all these facts more accurately continue in the scientific literature until now.

During an analysis of the above information of the Georgian sources about the attack on Ardebil and afterward other cities of Iran, Ivane Javakhishvili refers to the Armenian historian Vardan who considers 1210 as the date of these events, the dateless data of the Armenian chronicles Kirakos Gandzakeli and the Arab historian Ibn Halikan who dated these events by 602-603 AH, i.e., 1206-1207 CE. However, because Ibn Halikan "had taken the data about this campaign ... from the narration of the chronicler Ibn Batish who considered the date as 606 AH, i.e. 1209-1210 BC," the research does not exclude that Vardan, Kirakoz and Ibn Halikan had combined two campaigns: the first, to Ardebil in 1207-8 and the second one, during which the Georgians reached Rom-Guri in 1210.³³

³¹ Kartlis tskhovreba, p.301; KARTLIS TSKHOVREBA (2008), 356..

³² Vakhushti Bagrationi. Description of the Georgian Kingdom. Kartlis tskhovreba, IV, text, established according to all basic manuscripts by S. Kaukhchishvili, "Soviet Georgia", Tbilisi, 1973. pp. 189-191.

³³ I. Javakhishvili, History of the Georgian Nation, Writings, II, Tbilisi, p. 289

The dates defined by Ibn Halikan were questioned by T. Natroshvili and G. Japaridze, who considered Ibn Batish, according to which Marand was seized in 606 (1209-1210), to be more trustworthy³⁴. Based on this information, the researchers dated the campaign in Iran in the autumn of 1209³⁵.

It is noteworthy that G. Japaridze did not mention the campaign in Iran in his fundamental research.³⁶ When the research of T. Natroshvili and G. Japaridze – "Attempt to Establish One Date" – was published, and the work of R. Kiknadze "Parsadan Gorgijanidze³⁷ and "The Histories and Eulogies of the Sovereigns" (1975) in which one rather noteworthy observation is presented that the so-called first historian of Tamar had not existed, which changes the situation completely. Despite this, it was undeservingly committed to oblivion. This is about the Muslim attack on Ani during the fast preceding Easter and the counterattack of Georgians on Ardebil. R. Kiknadze provides the days of Easter and "Eid al-Fitr" and the table of the beginning of Ramadan in 1205-1210, and as it appears, the Easter precedes Ramadan only in two cases, in 1205 (601 AH, April 10, April 22) and 1206 (602 AH, April 2, April 11). R. Kiknadze defined the date under question as 1205, which seems logical, i.e., the information of the Arab author Ibn al-Athir about the Georgian invasion of the Islamic country from Azerbaijan in 601 (1204/5)³⁸ is confirmed. According to a well-substantiated conclusion of R. Kiknadze, "the Sultan of Ardebil destroyed Ani on April 10, 1205, on the day of Easter. Tamar was informed about this fact a week later, on April 17, in Geguti. Five days later, on April 22, the 30-day Muslim Fast, Ramadan, began. After its completion, on May 22 of the same year (on the first day of the month of Shawwal, 601 AH), on the day of "Eid al-Fitr", the Georgian

³⁴ T. Natroshvili, G. Japaridze, Attempt to Establish One Date, p.157

³⁵ T. Natroshvili, G. Japaridze. Attempt to Establish One Date, p. 157.

³⁶ G. Japaridze, Georgia and the Islamic World of the Near East, Tbilisi, 1995.

³⁷ R. Kiknadze, Parsadan Gorgijanidze and "The Histories and Eulogies of the Sovereigns, 1975.

³⁸ Materials of the history of Azerbaijan from "Tarih-al-Kamil" by Ibn al-Asir, Azfan, Baku 1940, 130.

army raided Ardebil."³⁹As for the following facts, according to the first historian of Tamar, the Mkhargrdzelis – Amirspasalar (Commander-in-Chief) Zakaria and Master of Servants, Ivane proposed that Tamar conduct a campaign into Iraq, to Romgur, which is Khuarasan. These persons, in the same way, are also mentioned by the chronicler during the campaign to Ani (1205, 10 April)⁴⁰ As seen from the inscription of Gunia-Kala, Ivane was granted the title of Atabeg during the life of Tamar, while the title of Amirspasalar (Commander-in Chief) was granted to him after the death of his brother, Zakaria. Before that, he was the Master of Servants and was replaced by Vache in this post⁴¹.

Sh. Darchiashvili reviews Armenian records from which it is clear that Lasha Giorgi was enthroned in 1210 (inscription of Haghbat of 1210)⁴² and Tamar was not alive that year or that Lasha was the sole king in 1210/11, but there was not the same respect towards him as had been towards Tamar in the related inscriptions. Sh. Darchiashvili notes that Tamar is mentioned in inscriptions as "great," "goodservant," "blessed by God," "queen of queens." Zakaria Mxargrdzeli" calls her "Lord" while himself calls "slave." In a Bagavan inscription of 1210/11 Amirspasalar Zakaria informs us that: "During the reign of Alasha, in the hope of the Lord, I, Amirspasalar Zakaria, came from Khlat to the sacred brotherhood of Bagavan ...", i.e., after the unsuccessful campaign to Khlat⁴³. Above-mentioned the 1210 Haghbat inscription was not considered to be

³⁹ R. Kiknadze, "Parsadan Gorgijanidze³⁹ and "The Histories and Eulogies of the Sovereigns", 1975, 1975, p. 128.

⁴⁰ Kartlis Tskhovreba, 374, 373; Kartlis tskhovreba(2008),p.471, 469

⁴¹ G. Otkhmezuri, Georgian Lapidary Inscriptions of the turn of the 12th-13th centuries, as a historic source, pp. 20-22.

⁴² Sh Darchiashvili. The issue of chronology of the early 13th century of Georgia – Mnatobi, 1975,2, p. 151-159; Sh Darchiashvili. Research of the Georgian-Armenian relations . The information of Armenian Lapidary inscriptions concerning Georgia in the XII- first three decades of the-XIII cc.,pp. 56,58.

⁴³ Sh. Darchiashvili, The Issue of the Georgian chronology of the early 13th century, Mnatovi, 1975, 2, p. 151-159; Shanshe Darchiashvili, Searches from the History of Georgian-Armenian Relations, Data of Armenian Lapidary Inscriptions about Georgia in the 12th c. – 1st third of the 13th century, Tbilisi, 2010, p. 152.

trustworthy by I. Javakhishvili. According to the inscription, it was minted in the year of the coronation of Lasha Giorgi, while Zakaria Mkhargrdzeli mentions the King and not Kings here⁴⁴. According to the researcher, the second coronation of Lasha and the beginning of his sole kingdom must be implied here. The 1206 Marmet inscription "During the reign of Lasha" is certified in the work⁴⁵, which I. Javakhishvili also did not trust. An analysis of 1221 Haghbat inscription is offered according to Hohanes, appointed as the saint bishop of Haghbat in 1205, as dated by a large part of researchers (dated by 1208 by a small number of researchers), considers Tamar and Lasha Giorgi to be co-Kings. According to well-supported opinion of Sh. Darchiashvili, the above sources question the date of the death of David Soslan established in the scientific literature: 1207. The author continues to discuss the death of David Soslan, remembers the date of the Battle of Basian - 1202/3. For some reason, however, this date is 1202, which is established accurately in scientific literature. According to the so-called first historian of Tamar, David Soslan died soon after the Battle of Basian. The researcher does not consider it correct to date the death of David by 1207. But as I. Javakhishvili dated the Battle of Basian in 1206 and the death of David in 1207, the author exercises particular caution and dates the death of David in 1205/6 instead of 1205, after which, in his opinion, the reign of Lasha Giorgi as the co-king began. It is also noteworthy that according to the material provided in his research, this date must be 1205 or 1208, more likely, the first one.

The date of the death of David Soslan was addressed by B. Bulia in her work "Images of Historic Persons in the Temple of the "Baptist" Monastery." Based on analysis of images of Tamar, David and Lasha Giorgi, based on the observation

⁴⁴ Sh. Darchiashvili, Searches from the History of Georgian-Armenian Relations, Data of Armenian Lapidary Inscriptions about Georgia in the 12th c. – 1st third of the 13th century, p.56.

⁴⁵ Sh. Darchiashvili, Searches from the History of Georgian-Armenian Relations, Data of Armenian Lapidary Inscriptions about Georgia in the 12th c. – 1st third of the 13th century, p. 63.

made by Ekvtime Takaishvili, the researcher considers that the scene of the coronation of Giorgi Lasha at the age of 13 is represented on the fresco which is dated 1205-6 by the researcher. Afterward, the author considers that "David Soslan is depicted as undoubtedly alive in the frescoes of the temple," which, in her opinion, is "an additional for those scholars who have established 1207 as the date of the death of Soslan." At the same time, the author explains why it became necessary to coronate Lasha during David's life⁴⁶.

Interesting data for clarification of the issue are provided from Armenian inscriptions in the research of G. Abdaladze⁴⁷. R. Kiknadze, based on Parsadan Gorgiojanidze and Vachushti Bagrationi, concludes that David Soslan must have died on April 10 of 1205⁴⁸.

According to Ibn al-Athir, Georgians seized Kars in 603 (1206/7), but the fight for Kars continued for many years and when nobody provided assistance to its possessors against Georgians, they surrendered. "The Chronicle of Abkhazs" totally agrees with it according to which "from k'oronikon ukz (427- 1207) FROM CREATION (6811-1207) Kars was seized and the Queen Tamar died. At that time, her son Lasha was twelve years old during the first campaign of the army"⁴⁹. According to the above source, possibly in about 1205 the first campaign to Kars was organized. That year Giorgi Lasha put the king's crown on his head, and Tamar's army approached Kars for the first time. "During that period, her (Tamar's) son was twelve years old" ["The Chronicle of Abkhazs"]⁵⁰.

⁴⁶ Marine Bulia, Images of Historic Persons in the Cathedral of the "Baptist" Monastery – Antiquities of Georgia, 7-8, 2005, p. 190.

⁴⁷ Sh. Darchiashvili, Searches from the History of Georgian-Armenian Relations, Data of Armenian Lapidary Inscriptions about Georgia in the 12th c - 1st third of the 13th century, pp. 212, 216; G. Abdaladze. Once Again about the Date of the Death of King Tamar, a collection of scientific works, V collection of scientific works of the Signaghi (Kakheti) branch of TSU, Signaghi, 2004, p. 12.

⁴⁸ Kiknadze R. K. Source Studies Essays of the History of Georgia. Parsadan Gorgijanidze and Kartlis Tskhovreba, Metsniereba, Tbilisi, 1980, 147.

⁴⁹ T. Zhordania, Chronicles, I, Tbilisi, 2004, p. 294.

⁵⁰ T. Zhordania, Chronicles, I, p. 294.

An anonymous Persian chronicler of the 13th century⁵¹ also tells us about the several-year siege of Kars. According to the second historian of Tamar, in the 23rd or 24th year of her rule, Tamar asked about Kars, "because Sargis Tmogveli, Shalva Toreli, and the Meskhis fought for a long time but could not seize it ... So she decided and sent David with the army. She sent Zakaria and Ivane with him and ordered them to stay there and fight strongly and it lasted for so long that Tamar went to Javakheti and waited for the news there".⁵² At the end of the battle, it is said that "the remaining people asked David that Tamar came and they trusted her. She came and they put the locks of the fortresses before her son Giorgi and then before Tamar and asked for peace and vow..."⁵³ The chronicler of the period of Lasha Giorgi mentions in the section on Lasha that "his parent, the Great King of Kings, Tamar, conducted a campaign for his fate (on his behalf?) and seized Kars". David is not mentioned here, however, in the section of Tamar, in the list of "the participant of all of these victories and actions" was Tamar's husband David, Kars is also mentioned.⁵⁴ As it seems, David Soslan participated in the battle for Kars, but it was not seized during his life. According to the comparative study of data of the sources, G. Japaridze concluded that Georgians occupied Kars Fortress in December 1206 or January 1207.⁵⁵ According to the information provided by Ibn al-Athir, following the seizure of Kars, the Muslims waited for the further activation of Georgians with fear, but "the Lord protected the protectors of Islam, sent death to the Queen of Kurjs and afterward confrontation began between them and he stopped their

⁵¹ N. D. Miklouho-Maclay, geographical compositions in Persian. A new sources on the historical geography of Azerbaijan and Armenia, scientific notes of the Institute of Oriental Studies of the USSR, volume IX, 1954, p. 208;

Data of the "Wonders of the Universe" about Georgia and the Caucasus. Persian text with the Georgian translation, introduction and comments issued by R. Kiknadze, Tbilisi, 1978, pp. 32, 43.

⁵² Kartlis Tskhovreba, p. 405.; KARTLIS TSKHOVREBA, 2008, 508.

⁵³ Kartlis Tskhovreba(1996), 405; Kartlis Tskhovreba, 2008, 508-509.

⁵⁴ Kartlis Tskhovreba, pp. 301, 299-300; Kartlis Tskhovreba, 2008, 354.

⁵⁵ G. Japaridze, Georgia and the Islamic World of the Near East, p. 162.

cruelty by the end of the year."⁵⁶ Even though the Queen and not the King is clearly written in the above information from Ibn al-Athir, several researchers believe that it was David Soslan. As previously mentioned, the surviving sources do not confirm this and [place the death of David in 1205.

Despite the publication of several research studies, the issue of Tamar's death calls for attention again and different dates are specified in the textbooks too. But, unfortunately, all sources which have reached us, must to be dated.

Several assumptions are expressed in the literature regarding the above fresco of the Baptist Monastery: that in this case Lasha's coronation by the Lord is shown. The legitimacy of his future power⁵⁷ shows Giorgi Lasha prior to this or that coronation and prepares the society for painless transfer of power later (particular importance must have been attached to this fact considering the internal political crises of that period)⁵⁸; that Giorgi Lasha's coronation was depicted on the fresco preserved in the Baptist Monastery (according to the records of E. Takaishvili). "Due to the age of Giorgi Lasha, his first coronation is depicted during the life of Tamar and David, in about 1205-1206⁵⁹.

All information from all sources certainly begins with doubt, and one may cast doubt on the information of Ibn al-Asir by which Tamar's death is dated by 1207, even though this date is confirmed by a number of other properly reviewed sources which have been mentioned several times. The information from Georgian chroniclers confirms this date. However, in some cases, they are

⁵⁶ Materials of the history of Azerbaijan from "Tarih-al-Kamil" by Ibn al-Asir, Azfan, 1940, p. 131.

⁵⁷ Z. Skhirtladze. The royal ktetor portrait in the main temple of Gareji Baptist Monastery, Soviet Art 11, (1983), 96-110; M. Pataridze, I. Paghava, Numismatic depiction of the coronation of Giorgi Lasha, a historical collection 3, 2013, 208-209.

⁵⁸ M. Pataridze, I. Paghava, Numismatic depiction of the coronation of Giorgi Lasha, a historical collection 210. ANTONY EASTMOND. ROYAL IMAGERY IN MEDIEVAL GEORGIA, PENNSYLVANIA, 1998, 137.

⁵⁹ M. Bulia, Images of Historic Persons in the Cathedral of the "Baptist" Monastery – Antiquities of Georgia, 7-8 (2005), 186-8.

questionable. At the same time what is introduced instead is not convincing either. The chronicler of Lasha Giorgi indicates as a date of death of Tamar k'oronikon four hundred twenty seven ($780+427=1207$), but notes that Tamar was in reign twenty-three years".⁶⁰ According to the second chronicler of Tamar, after the seizure of Kars: "twenty third or twenty fourth year of her reign she asked about Kars",⁶¹ that coincides with the date of chronicler of Lasha Giorgi. At the same chronicle, seizure of Kars is followed by the other evidence: "And to whom these affairs made by Tamar and her troops within ten seventeen (in Georgian "atchvidmetsa") seem not sufficient."⁶² By the assumption of Th. Jordania here joint years of Tamar and her husband David are implied, from 1189,⁶³ but if David had been alive in times of the seizure of Kars that is doubtful. It is noteworthy that Jordania, who does not place the death of Tamar in 1207, does not accept the date of Ibn al-Athir, the evidence of the latter put by mistake in 1208-9. Jordania also reads "atchvidmetsa" as 17. That is wrong. If so, it had to be "atshvidmetsa". Here we have "atchvidmetsa," that is $10+17=27$, which we had to add to 1179, the beginning of Tamar's reign, that is 1206, the seizure of Kars.

The first Chronicler of Tamar sums up the years of Tamar's reign: "seized by the Sea Pontos to Gurgen and from Speri to Daruband and all Caucasians Trans-Caucasians and beyond up to Khazaria and Scythia... during her 12 years' reign."⁶⁴ In this context, 12 is mentioned twice. In the manuscripts, 12 is mentioned the most, although there is also 11. I. Javakhishvili in the first case read 11, in the second one, 12.⁶⁵

⁶⁰ Kartlis tskhovreba (1996), p.300; Kartlis tskhovreba (2008), p.355 507.

⁶¹ Kartlis tskhovreba (1996), p. 407; Kartlis tskhovreba (2008), p.508.

⁶² Kartlis tskhovreba (1996), p.; Kartlis tskhovreba (2008), p. 507.

⁶³ Chroniques (by Th. Jordania, 2004), p. 296.

⁶⁴ Kartlis tskhovreba (2008), p. 408.

⁶⁵ I. Javakhishvili. The Historians of the king Tamar. - The goals, sources, and methods of history in early times and at present. -Book I,- The works,8, Tbilisi, 1977, p.222.

K Kekelidze decided that 11 as well as 12 was a proof mistake and replaced them by 31⁶⁶. In the opinion of Mikheil Bakhtadze, the reign of Tamar started in 1179 and 1184, because if we accept the latter, the seizure of Kars appears to have taken place in 1207 or 1208, which is impossible in his opinion. The main argument of the researcher is that "Overall, David Soslan was not alive during that time,"⁶⁷ which is presumably correct. M. Bakhtadze refers to N. Shoshiashvili, who also considers Tamar's reign from 1179, and added 31. Perhaps here the most fruitful joint years of Tamar and David are implied from Lasha Giorgi's birth until his first coronation (1193-1205).

All of the information from Armenian written sources contradict the above. They prove only that Tamar was not alive in 1210 and Lasha was enthroned that year. This is clearly confirmed by the Haghbat inscription of 1210. "which was inscribed in the year of the coronation of Tamar's son the King of kings Giorgi."⁶⁸

However, if we assume that Tamar had passed away in 1207 and the second coronation of Lasha Giorgi took place in 1210, what happened in 1207-1210? Maybe we should remember the information of Ibn al-Asir about the unrest in Georgia which followed the death of Tamar and assume that Lasha was not allowed to be enthroned. No particular military activity is seen from Georgians until a certain time, and attacks of Georgians on possessions of Ayubians were resumed only in 605 AH, 16.07.1208 – 5.07. 1209 and campaign was conducted to Archeshi and Khlat. The above events are reviewed by G. Japaridze in detail.

Returning to the numismatic data, which is decisive for clarification of the issue and is mentioned in the literature several times, fair and biased coins were minted in the period of Lasha Giorgi too. There is a controversy in the literature

⁶⁶ History and eulogies of the haloed (Attempt of restoration of the text). By editing and research of K.Kekelidze, Tbilisi, 1941 (Russian), p. 19; Kartlis tskhovreba, Tbilisi, 2008, p. 408.

⁶⁷ M. Bakhtadze. Once Again about the Date of the Death of King Tamar, works on the history of Georgia, Ivane Javakhishvili State University of Tbilisi, II, 2011, 221.

⁶⁸ Sh Darchiashvili. Research of the Georgian-Armenian relations.p. 57.

regarding the dating of a fair coin which is comparatively rare and has Georgian and Arabic inscriptions: "Ch. of the King Giorgi, son of Tamar, ruler of Javakhs" (read by N. Berdzenishvili⁶⁹) and in Arabic "the Supreme King, the beauty of the country and religion, Giorgi, son of Tamar, sword of the Messiah". N. Berdzenishvili did not have a definite answer to this question. The researcher reviewed various opportunities and supports the assumption that at the moment of minting the coin "Lasha was still a co-King."⁷⁰ According to D. Ninidze, mentioning only Giorgi on the coin means that at the time of the minting the coin, only Giorgi Lasha was on the throne. This happened after Tamar's death and that Giorgi's enthronement as the sole king in the southern region of Georgia was especially celebrated in this manner because king of Georgia "was particularly the Lord of the Javakhs here."⁷¹ Ir. Paghava studied the above-mentioned coin in detail and concluded that it was minted in the years of reign of Giorgi as the co-king.⁷² In his opinion, the likelihood of issuance of this coin after the death of Tamar is lower."⁷³

We have many Lasha's biased coins dated by 1210 with (or sometimes without) Georgian and Persian inscriptions, in both cases dated by k'oronikon (430-1210) without AH. It is assumed that this coin was minted for internal use.⁷⁴

There is one more unique fair coin minted in the name of Lasha Giorgi with the image of the crowned king, which was addressed by several researchers and recently and rather widely. It was covered by Maia Pataridze and Irakli

⁶⁹ I. Paghava. The coins of " - "Lord of the Javakhs" - complex analysis.- Historical collection.I, "Mxedari", 2011, p. 297.

⁷⁰ N. Berdzenishvili, Diary (Report) of 1933 Javakheti Expedition, Issues of the History of Georgia, 1, Tbilisi, 1964, p. 145.

⁷¹ D. Ninidze, History of the Branches of Royal House of Bagrationi, Tbilisi, 2004, p. 23.

⁷² Irakli Paghava, Coins of the Lord of the Javakhs, a comprehensive analysis, a historical collection, 1, Tbilisi, 2011, 291-344.

⁷³ Irakli Paghava, Coins of the Lord of the Javakhs, p. 303.

⁷⁴ Kapanadze, Georgian numismatics, Tbilisi, 1950, p. 51.,

Paghava.⁷⁵ In the opinion of the researchers, Lasha's coronation is depicted on the coin. The date is specified on the coin by k'oronikon which is read as 430, at the same time the Arabic and Arabian diagram date which is read as 606 AH (6.VII, 1209-24. VI 1210). Based on this date, G. Abdaladze considers that Tamar died in the first half of 1210 and her son, Lasha Giorgi was enthroned. Here one can recall that Giorgi III enthroned in 1156 issued coin in 1774, Tamar enthroned in 1184 just in 1187 minted coin. Thus, a coin minted in 1210 is not a reliable argument for clarifying the coronation date. However, this date is confirmed by the above-mentioned Haghbat inscription.

If Tamar died in 1207, how should we explain the gap until 1210? Do we have some additional arguments why the coin was not minted until 1210? Then, we should either agree with the assumption of Ts. Ghvaberidze that Tamar's coin was not minted in 1210 and the coins of 1187 are dated erroneously, or we should consider the opinion of all other researchers, including J. Odisheli who dates the death of Tamar in 1207 and those who date a part of coins minted in the name of Tamar by 1210. As J. Odisheli mentions in his research, he specially studied the coins of Queen Tamar dated 1210 and saved in the numismatic depositories of S. Janashia State Museum of Georgia and concluded that the above coins were minted in the name of Tamar and dated by k'oronikon ul, i.e., 1210 (480+780)⁷⁶.

Using the arguments provided, we may assume that Tamar did not mint the 1210 coin. It was minted after her death by others in her name during a confrontation between the two governmental groups to prevent Lasha Giorgi and his supporters from engaging in active governance.

⁷⁵ M. Pataridze, I. Paghava, Numismatic depiction of the coronation of Giorgi Lasha, a historical collection 3, 2013, pp. 214-254.

⁷⁶ J. Odisheli, For Determining the Date of One Issue of Georgian Historical Chronology – the Death of King Tamar, historical essays, 2010, p. 291.

The situation drastically changed very soon. The captivity of Ivane Mkhargrdzeli during the campaign to Khlat (1209-1210) became a heavy burden for the Georgian state (redemption in the amount of 100,000 (80,000 or 200,000) dinars, return of 2,000 or 5,000 captives, and 21 fortresses⁷⁷. A wound received during the battle resulted in the death of Zakaria Mkhargrdzeli, according to the Armenian authors, Vardan, Stepanoz Orbeliani and the data of Armenian inscriptions, in 1212,⁷⁸ or 1211 (Smbat Sparaspet)⁷⁹ arranging the marriage of Ivane's daughter, Tamta to Avhad (the future life of Tamta was very hard) shook the power of the Mkhargrdzeli which was absolutely protected during the reign of Tamar and during the following years. Presumably, this allowed the supporters of Giorgi Lasha to enthrone him as a sole ruler and mint a coin in his name in 1210. However, despite everything, due to unstable conditions, they did not continue Tamar's reform during which a fair coin was minted in 1200 CE, and they continued the tradition of minting a biased coin again. And if this is the case, when must all of this have happened? As established by G. Japaridze, Ivane Mkhargrdzeli was taken captive in the month of 19 Rabi' as-San in 607 AH/10.X.1210; however, he mentions another date specified in Arabic sources – the month of 19 Rabi' as-San in 606, i.e., October 21, 1209, Wednesday⁸⁰, after which Lasha's supporters could freely act (G. Japaridze, pp. 168-169).

In 1975 a conference dedicated to N. Berdzenishvili was held in Javakhishvili Institute where the issue of the death of Tamar was discussed. Some scholars did not accept the date of 1207 supported by L. Tuchashvili, who also supposed that Lasha's coronation was postponed until 1210. This helped to create a myth

⁷⁷ G. Japaridze, *Georgia and the Islamic World of the Near East*, Tbilisi, 1995, p. 169.

⁷⁸ Vardan Araveltsi. *World History*, translated from Old Armenian by Nodar Shoshiashvili and Eka Kvachantiradze, Tbilisi, 2002, 158, 233.

⁷⁹ G. Japaridze (About the date of the death of Queen Tamar, *A historical collection*, 2, TB. 2012, 356

⁸⁰ G. Japaridze, *Georgia and the Islamic World of the Near East*, 168, 169.

about the "parental" care of Lasha Giorgi by Mkhargrdzelis and their panegyric⁸¹.

Thus, based on the reviewed material, it is established that:

- The enthronement of Lasha born in 1192-93 as the co-king began in 1205 after the death of his father, David Soslan;
- The Georgian campaign to Iran and struggle for Kars, which apparently stopped after the death of David, took place the same year;
- Kars was seized at the end of 1206 or at the beginning of 1207;
- Tamar died in 1207. This was followed by internal confrontation among the Georgians, between supporters of Lasha Giorgi and Mkhargrdzelis;
- Because of the unstable position of Lasha Giorgi and opposition of Mkhargrdzelis, the enthroning of Lasha for the second time, as well as the minting of the coin with his name as a sole king and ruler, was not possible till 1210.
- Considering all the evidence mentioned above, the conclusion made by Ts. Ghvaberidze concerning the mistake made on the coin of 1187 issued in 1210 seems the most convincing.

⁸¹ Proceedings, Series of history, 1975, 3, p. 164.

*Hamid Asad Pour*¹,

*Masoud Vali Arab*²

The Georgian of Shushtar at the Safavid Era (10421144 AH) (16201722 AD)

The history of Georgian's ruling of Shushtar dates back to the reign of Shah Safi. During the reign of Shah Safi, one of his outstanding servants, Vakhastu Khan was chosen to serve as the governor of Shushtar. This person's entering into Shushtar, who had promoted from being a special servant to the Biglarbeigi position, is considered as a turning point in the development of Shushtar. Vakhusti khan and his brothers were promoted in the Safavid court because of their loyalty to this dynasty. Therefore, Vakhastu Khan was appointed as the governor of Shushtar, and his brother, Zulfiqar Khan, was appointed as the ruler of Kandahar. They could protect Shushtar and Kandahar very well using their tact so that the Georgians ruling of Shushtar lasted for 102 years. Finally, the ruling period of this clan was declined and disappeared by Nader Shah. This research aims at investigating the sociopolitical situation of Shushtar at the time of Vakhastu Khan and his successors.

Keywords: Safavids, Georgians, Vakhastu Khan clan, Shushtar.

¹ Assistant professor of history, Faculty member, Persian Gulf University, Bushehr, Iran

² Ph.D. candidate of history, Persian Gulf University, Bushehr, Iran

During 946, 947, and 960 AH (1524, 1525, and 1538 AD), Shah Tahmasp I attacked the Caucasus under the pretext of jihad desiring to earn great wealth. After these fights, the Safavids earned a lot of trophies, and many Georgian women and children also came to Isfahan, the capital of the Safavid. These women and children established the basis of a "third force" that was later organized by Shah Abbas I. In order to reduce and balance the power of Tajik and Ghezelbash, Shah Abbas I made use of the "third force" element, which included Georgians, Circassians, and Armenians. The power of this element gradually increased at the time of Shah Abbas (I), so that Allahverdi Khan was one of the Georgian generals at the time of Shah Abbas. After the death of Shah Abbas and at the time of Shah Safi, the power of Georgians increased to the point that Shah Safi became suspicious of the Emam Gholi clan, who were the children of Allahverdi Khan, and ordered their massacre.

Another Georgian clan at the time of Shah Safi, which was given the Biglarbeigi position, was the Vakhushti Khan clan which had a significant effect on the development and prosperity of Shushtar. Here, the question is what roles the Georgians of Shushtar played in the social situation of Shushtar in 1042 1144 AH (1620-1722 AD). The hypothesis is that the Georgians of Shushtar had a significant effect on the prosperity, agricultural development, and the construction of public buildings in Shushtar.

There is no independent investigation on the Georgians clan of Shushtar, and the only source that referred to this clan is the biography of Shushtar. The sources of the Safavid period have provided only some rudimentary information in this regard.

The importance of the current study, which is a library research study using a descriptive-analytic method, is that it investigates the arrival of Georgians and their impact on the political and social situations of Shushtar. Furthermore, using the primary sources of the Safavid era and all the sources related to this era, this study attempts to examine the actions and services of the Georgian

Vakhashtu Khan clan, who were selected as the biglarbeigi of Shushtar by Shah Safi.

The literature on the arrival of Georgians at Shushtar

Shah Tahmasp I attacked the Caucasus four times under the pretext of jihad in 946, 947, and 960 AH (1524, 1525, and 1538 AD). Tahmasp's motive to send troops to the Caucasus may have been the same as those his ancestors Junaid, Ismail, and Haidar, who intended their armies to gain experience from the wars and earn trophies in this way. The majority of the captives brought to Iran from the Caucasus during the reign of Shah Tahmasp I were children or women. The descendants of these children and women established the basis of the "third force" that was later organized by Shah Abbas I (Seyouri, 2007).

In order to reduce the power of Tajiks and Ghezelbash, whose power was rising and who were conflict with each other, Shah Abbas I sought a solution. His solution was to create the "third force" consisting of Circassians, Georgians, and Armenians who were first brought to Iran in the time of Shah Tahmasp (I). Later, they became known as the slaves of Shah. After accepting Islam, these slaves were employed in the army and other sections of the royal houses (Navaei and Ghaffari Fard, 2007).

Using Georgian, Circassians, and Armenian slaves, Shah Abbas created a permanent army that was always available. These slaves had only one purpose: to show loyalty to the king. The new regiments of slaves created by Shah Abbas included cavalry formations of up to 10,000-15,000 soldiers armed with ordinary guns and weapons. Shah Abbas also created an army composed of gunmen and gunners and increased the number of the royal soldiers – who were mainly chosen from the slaves – to 3,000 (Seyouri, 2007).

This "third force" gradually gained reputation at the time of Shah Abbas, and their power increased. However, the influence of this force in the Safavid

dynasty was not limited to Shah Abbas's time alone. Their presence was also evident during the reigns of his successors.

Shah Abbas's grandson, Sam Mirza, the son of his eldest son – Mohammad Baqir who became known as Safi – succeeded the throne. Sam Mirza took his father's name, Safi, on the throne. During the reign of Shah Safi, some influential members of the Georgian clan like ImamQuli Khan and his sons were killed. ImamQuli Khan was the son of Allahverdi Khan, who was Shah Abbas' commander in chief. This action by Shah Safi reflected the great influence and power of Georgians, especially the ImamQuli Khan clan, had in the Safavid dynasty. This caused Shah Safi to order their deaths due to his fear of this clan, or as some said, because of his jealousy (Seyouri, 2007).

During the reign of Shah Safi, the Georgian element gained so much power that traces of it are still evident in the city of Shushtar in Khuzestan. The oldest sources that point to the presence of Georgians are the Jahan Ara history of Abbasids by Vahid Qazvini, the biography of Shushtar by Seyyed Abdullah Jazayeri Shushtari, and Tohfatal Alam by Mir Seyyed Abdul Latif Shushtari. In this regard, a detailed description of an influential clan of Shushtar named "Vakhashtu Khan" is written by the author of "biography of Shushtar."

One of the most famous Georgian clans of Shushtar was the "Vakhashtu Khan clan" who were considered as the special slaves of Shah Safi (1038-1052 AH) (1616-1630 AD) and promoted to the position of Biglarbeigi (AlHosseini Qomi, 2004; Vahid Qazvini, 2004). In public view, the members of this clan were known for their beauty. They were located in the vicinity of Salasel castle of Shushtar.

Social and political situation of Shushtar at the time of Vakhashtu Khan

The Vakhashtu Khan clan were the special slaves of Shah Safi from 1042 AH to 1144 AH (1620 AD to 1722 AD) who ruled Shushtar for 102 years. On the arrival

of Vakhashtu khan at Shushtar, who possessed "Sheshpar Ghoorchi" ¹⁸² position, the elders, sadat (Marashi, Ghiri and....), scholars, and the elites of Shushtar rushed to welcome him (Kasrawi, 2010).

During Vakhashtu Khan's ruling, the presence of their relatives and their devotees, including "Gorgin Beig" and "Eldorom Beig," increased in Shushtar. Gorgin Beig was later promoted to the status of "Mirshekari" (Imam Ahvazi, 2000; Jazayeri Shushtari, 2009). In the Safavid era, Mirshekari status was considered a second-rank position, comprising more than two hundred members responsible for maintaining birds of prey (goshawk). Birds of prey were used for hunting cranes, geese, and ducks (Navaei and Ghaffari Fard, 2007). Furthermore, "Mansour Khan" and "Zulfiqar Khan" were the brothers of Vakhashtu Khan that Zulfiqar Khan Biglar Beigi later became the ruler of Kandahar (AlHosseini Qomi, 2004; Hosseini Monshi, 2006).

It can be implied from the sources of the Safavid era that "Vakhashtu Khan" was very well-known for the development and prosperity of the agriculture and horticulture of Shushtar and for respecting the peasants. He developed Shushtar by planting trees and increasing agricultural productions (Vahid Qazvini, 2004).

Shah Safi did not disregard the actions taken by Vakhashtu Khan in the province of Shushtar. Therefore, he was promoted by Shah Safi when he returned from Kandahar, where his brother was its ruler, and a fixed salary and pension was considered for him like the Khans (Jazayeri Shushtari, 2009).

During the Safavid era, many battles happened between the kings of the Safavid dynasty and the Ottoman Empire. The first battle in 920 AH (1498 AD) was called the "Battle of Chaldiran." In the Safavids were defeated. The winner of this battle, Shah Suleiman Osmani, conquered Tabriz, the Safavid capital (Seyouri,

⁸² "Sheshpar Ghoorchi": Ghoorchian: They were the special guards of the Safavid Shah. Their commander was called Ghoorchi Bashi. The title of almighty was exclusively used for these positions: The governors, Biglar Beigis, The Khans, The kings, the supreme minister, Ghoorchi Bashi and so on (Navaei, and Ghaffari Fard, 2007).

2007). These battles continued even during the successors of Shah Ismail, and each of the Safavid kings applied some particular military tactics in these battles, sometimes leading to their victory and other times to their defeat. At last, a peace treaty was signed between the Safavid and the Ottoman in 1048 AH (1626 AD), ending the relentless bloodshed. One of the main consequences of this peace treaty was the tranquility and peace of the people of Khuzestan, which led to the improvement of agriculture in this region (Jazayeri Shushtari, 2009).

In addition to Vakhashtu Khan, others, including his minister, Haji Mohammad Sharif Ibn Khaje Ghasem Ibn Khaje Ali led the development of Shushtar. One of the close relatives of this minister, Khaje Hedayatollah Ibn Khaje Nematollah, who had lived in India for several years, was not satisfied with life during the reign of Vakhashtu Khan as he was blind (Jazayeri Shushtari, 2009). Khaje Hedayatollah was one of the anonymous poets of Shushtar who wrote the Biography of Shushtar, which is a primary source of the Safavid era.

During the reign of Vakhashtu Khan, "Haji Mohammad Taghi Kalantar," a very generous and good-natured man, held the Kalantar Bashi office (Sheriff). He and Vakhashtu Khan founded the Najaf Abad village as well as the castles of "Papi" and "Fili" and "Afozuni" in 1042-1078 AH (1620-1656 AD). Haji Mohammad Taghi Kalantar made every attempt to settle the peasants in these places, providing them with agricultural tools and seeds. The author of the book "The Biography of Shushtar" wrote about a poet named "Molla Kasebi" who produced a poem about the village of Najaf Abad and was a contemporary of Vakhashtu Khan.

Vakhashtu Khan reigned for thirty-seven years. Fathali Bieg, Eselmes Beig (Aslan Khan), Kalbali Beig, Badadeh Beig and Aslan Beig his children. He had many servants, each of them was a great emir in their own positions (Jazayeri Shushtari, 2009).

Sources of the Safavid era have referred to the actions taken by Zulfiqar Khan (the brother of Vakhshu Khan), who was the Beiglarbeigi of Kandahar. He repelled Aurang Zeib's attack on Kandahar, a provincial area contested by the Safavid and the Mughal of India in 1061 AH (1639 AD) (Qazvini, 1988). In fact, the power of Zulfiqar Khan in Kandahar province caused the Mughal kings of India to consider a military attack for seizing Kandahar as a last resort (Afshar Yazdi, 2001). Zulfiqar Khan passed away in 1071 AH (1639 AD) (Navaei, 1981; Vale Qazvini Isfahani, 2003).

The successors of Vakhshu Khan

A) Fatali Khan

Fath Ali Khan was to govern Shushtar after the death of his father, Vakhshu Khan. Fatali Khan ruled Shushtar from 1105 to 1178 AH (1683 to 1756 AD) and, like his father, respected Sadats and scholars and was the instructor of those who sought perfection. Eselmes Beig Khan (Aslan Khan), who was the governor of Shushtar on behalf of Fatali Khan, welcomed Seyyed Nematollah Jazayeri with great honor. Moreover, Aslan Khan procured the requirements for Seyyed Nematollah Jazayeri as if it deserved the lord of wisdom, also a home was provided for Seyyed in the vicinity of the grant mosque of Shushtar (Imam Ahvazi, 2000; Jazayeri, 1997; Marashi, 1986; Niroumand, 2005; Shushtari, 1984).

Fath Ali Khan, like his father, attempted to make Shushtar a prosperous and developed city. He also constructed many monuments, including Shah Abad, Ali Abad, Dolat Abad, Fath Abad places, Aghili gardens, Mahi Bazan dam, Hesam Abad mansion, and the Khan's bathroom. Furthermore, he reconstructed most of the mansions of Salasel castle and Kaiser bridge (Shadravan) that had been destroyed in the past (Kasrawi, 2010). While Fath Ali Khan was the ruler of Shushtar, he attempted to remove the silt from the Glougard aqueducts and

Choubband lands from mud, but his efforts were fruitless. It should be mentioned that the Sadat clan, Marashi Sadat clan, and Jazayeri Sadat clan were respected well by Fatali Khan (Ibid, p. 139).

B) Kalb Ali Khan

Safavid Shah Soleiman died on Dhu al-Hijjah 1105 AH (September 1683 AD), and Shah Sultan Hussein came to the throne on Muharram 1106 AH (October 1684 AD). He sent Aslan Khan (Eselmes Beig) – the son of Vakhastu Khan who was Gollar Agassi (the head of special servants) – to Kandahar and summoned Fath Ali Khan to Isfahan, the capital of the Safavids. In addition, he appointed the government of Shushtar to the other brother of Fath Ali Khan, i.e., Kalb Ali Khan, who entered the city of Shushtar in Jumada II 1106 AH (March 1683 AD). The Safavid king made benefit from the power of Vakhtashu Khan Georgian clan to solve external problems as well as to ameliorate the internal affairs, because the merit of this clan in controlling the affairs in Shushtar has been proven (Jazayeri Shushtari, 2009; Kasrawi, 2010).

During the ruling of Kalb Ali Khan on Shushtar (about 1106 to 1111 AH) (1684 to 1689 AD), there was a flood and the gardens and crops in Shushtar were destroyed. This flood is considered an introduction to the destruction of Shushtar, because some parts of the Mizan dam and Magham dam (Ali position) were destroyed, causing much destruction in Shushtar (Jazayeri Shushtari, 2009). Regarding Aslan Khan's ruling on the province of Kandahar, there is not much detailed information in the resources of the Safavid era (Naeini, 1974; Nasiri, 1994). The selection of Aslan Khan for ruling Kandahar Province happened in 1106 AH (1684 AD), and he became the ruler of Kohgiluyeh in 1114 AH (1692 AD). Upon reaching Kohgiluyeh, he came to Shushtar and stayed in Khajeh garden. Although Abudllah, the son of Aslan Khan, was a jovial and luxurious person. Since he loved his father very much, he constantly traveled to

Kohgiluyeh to visit his father. In this regard, when Aslan Khan became the ruler of Astarabad, his son quickly went to visit him. Another son of Aslan Khan, Mohammad Ali Beig (Khan), was the deputy of the ruler of Shushtar. Aslan Khan died in 1121 AH (1699 AD) in Astarabad (Jazayeri Shushtari, 2009).

C) Isa Khan and Abdullah Khan:

From 1111 to 1113 AH (1689 to 1691 AD), Isa Khan, the son of Zulfiqar Khan (Vakhashtu's brother), was the ruler of Shushtar. He favored peasants and was also very interested in Shushtar and respecting the poor, but his reign was very short. In 1113 AH (1691 AD), Abdullah Khan, the son of Aslan Khan (Vakhashtu's son) became the ruler of Shushtar and was its ruler for eleven years (1113-1124 AH) (1691-1702 AD) (ibid, pp. 141-142).

D) Mehr Ali Khan

In 1129 AH (1707 AD), Mehr Ali Khan, the son of Kalb Ali Khan, became the ruler of Shushtar. His brother, Haji Muhammad Khan, became the deputy of the ruler of Shushtar. However, this appointment did not last long, and Abdullah Khan became the ruler again. These changes showed the weakness of the Georgian government in Shushtar, especially Abdullah Khan. On Jumada AlAwwal 1134 AH (February 1712 AD), the Soltani war began in Gloun Abad between the Safavid army and the troops of Afghan Mahmud who defeated the Safavid army put Isfahan, the capital of the Safavid, under the siege. During the siege of Isfahan, Mehr Ali Khan, the son of Kalb Ali Khan, was appointed ruler (Jazayeri Shushtari, 2009).

The End of the Vakhashtu Khan Clan

The quick ascent of the Vakhashtu Khan clan in administrative affairs was not very evident in the history of Iran. Mirza Tahmasp, the son of Shah Sultan

Hussein, who survived the siege of Isfahan was crowned in Qazvin on Safar 1135 AH (November 1713 AD). Mohammad Ali Khan, the son of Aslan Khan, was appointed as his minister of the state (Imam Ahvazi, 2000; Jazayeri Shushtari, 2009; Kasrawi, 2010). The minister of state of a king who had no power would be without any authority as well.

From 1135 to 1144 AH (1713 to 1722 AD), Tahmasp Quli (Nader Shah) came to Isfahan and dethroned Shah Tahmasp II and appointed his young son, Abbas Mirza III as king. The government of Shushtar had been subjected to many seditions and rebellions. On the one side, the government of Shushtar was at the hands of Douragh and Hoveizeh Arab sheiks, and on the other side, Bakhtiari Khans were covetous towards Shushtar. Moreover, the ruling of the Vakhastu Khan clan also continued in a very weak manner (Jazayeri Shushtari, 2009). In addition to the three powers mentioned, there were disobedient Turks in the Safavid army. They were incompatible with the Georgian Vakhastu Khan clan and sometimes leaned towards Arab sheiks and sometimes tended towards Bakhtiari Khans (Ibid, p. 172).

Furthermore, the situation of Shushtar became more complicated and chaotic when the Heydari-Ne'mati disputes between Shushtarians was added to this chaotic situation. Heydari-Ne'mati are two contrasting sects which were in an ongoing and violent conflict with each other in the Safavid and Qajar eras in most cities of Iran, including Shushtar. The Heydari group followed to Qutb al-Din Heydar, one of the Safavid elders, and the Ne'mati group followed Shah Ne'mat Allah Vali. During Tasua and Ashura (martyrdom day of Imam Hossein), the conflicts between the two sects increased intensely so that Heydari and Ne'mati neighborhoods sometimes leaned towards Arab sheiks or Bakhtiari Khans, and sometimes tended towards Vakhastu Khan clan, and sometimes showed animosity and hatred towards Turkish Safavid army (Ravandi, 2003).

In general, the ruling intervals in that period brought numerous disasters for the people of Shushtar. Finally, with the coming of Nader Shah Afshar into power,

no myth of the power of Arab sheiks remained, not a trace of Bakhtiari Khan's defiance. With the rise of Nader Shah Afshar, the Vakhshatu Khan clan had no role in the government, and Georgian rule of Shushtar came to an end after a hundred and two years (1042-1144 AH) (1620-1722 AD) (Kasraw, 2010).

Conclusion

The first appearance and position of the Vakhshatu Khan clan were as the special servants at the court of Shah Safi (1038-1052 AH) (1616-1630 AD), but their remarkable policies and tact led to their promotion to the position of Biglarbeigi. The Biglarbeigi of Kandahar province, which was the border of Iran and the Gorkani government of India in the Safavid era was of the utmost importance. In addition to the development and prosperity of Shushtar, the Vakhshatu Khan clan also had the duty of guarding and preserving the Kandahar province. The political existence of the Vakhshatu Khan clan was significant in three different aspects. First, this clan did many services to the Safavid dynasty in their various positions for a long time. Second, the loyalty of this clan to the Safavid dynasty is praiseworthy because, for a hundred and two years of being the governor of Shushtar and being Biglarbeigi in the province of Kandahar, they never rose against the Safavids. Third, this clan was also present at the Safavid court holding the "Sheshpar Ghoorchi" position which remained in the Vakhshatu Khan clan until the end of the Safavid dynasty.

It should be noted that this clan also paid attention to the agricultural prosperity and the development of Shushtar as well. Furthermore, new neighborhoods were built during their ruling, and agricultural tools were developed, which was an essential step toward the agricultural development and prosperity of Shushtar.

After the decline of the Safavid dynasty, this clan was involved in the conflicts of Arab sheiks and Bakhtiari. It was also involved in disputes between Heydari and

Nem'mati neighborhoods gradually declined. Finally, with the arrival of Nadir Shah Afshar and the founding of the Afsharieh dynasty, the reign of this clan, which cared about the prosperity and development of Shushtar, ended after hundred and two years.

References

- Afshar Yazdi, I. (2001). The history office of documents collection and historical sources. First Edition, Tehran: Endowments institute of Professor Iraj Afshar.
- Al-Hosseini Qomi, Gh. A. bin Sh. (2004). Kholaseh alTavarikh. Second edition, Tehran: Tehran University Press.
- Hosseini Monshi, M. M bin M. (2006). Riyadh al-Ferdos Khani. First Edition, Tehran: Endowments institute of Professor Mahmoud Afshar.
- Imam Ahvazi, M. A. (2000). The history of Khozestan. First Edition. Tehran: Association of cultural figures and works.
- Jazayeri Shushtari, S. A. (2009). Biography of Shushtar. Edited by Mehdi Kadkhodaei Tarahi. Ahvaz: Tar Ava publication.
- Jazayeri, S.M. (1997). The genius of jurisprudence and Hadith, Seyyed Ne'matullah Jazayeri. Qom: Islamic Thinking Assembly.
- Kasrawi, A. (2010). The five-thousand-year history of Khuzestan. Third Edition. Tehran: Donyaye Ketab publication.
- Khafi, Sh. A. (2001). The reputation protector, Zobde alTavarikh. First Edition, Tehran: the Ministry of Culture and Islamic Guidance publication.
- Marashi, A. A. (1986). The genealogy of Marashi clan. Vol. 1. Tehran: Bina publication.
- Naeini, M.J. (1974). Jafari Encyclopedia. Tehran: Association of Scientific works.
- Nasiri, M. I. (1994). The order of Shahriyaran. First edition. Tehran: Endowments institute of Professor Iraj Afshar.
- Navaei, A. (1981). Iran's political documents and correspondence, Shah Safi. Second edition. Tehran: Association of Iran culture.
- Navaei, A. and Ghaffari Fard, A. GH. (2007). The history of political, social, economic and cultural developments in Iran in the Safavid era. Tehran: SAMT publication.
- Niroumand, M.B. (2005). A memory of Shushtar. First edition. Tehran: Association of cultural figures and works.
- Qazvini, A.H. (1988). The benefits of the Safavids. First Edition. Tehran: Institute for Cultural research and studies.

Ravandi, M. (2003). *The Social History of Iran*. Second Edition, Tehran: Nehah Publications.

Seyouri, R. (2007). *Iran in the Safavid era*. Translated by Kambiz Azizi. Eighteenth edition, Tehran: Nashre Markaz publication.

Shushtari, M. A. K. (1984). *Tohfato Alam*. By the efforts of Samad Movahhed, First Edition. Tehran: Tahouri library.

Vahid Qazvini, M. T. (2004). *Jahan Ara history of Abbasids*. First edition. Tehran: Research institute for humanities and cultural studies.

Vale Qazvini Isfahani, J. (2003). *Iran during the periods of Shah Safi and Shah Abbas the second*. Second Edition. Tehran: Association of cultural figures and works.

Yazdi, Sh. A. (2008). *Zafar Nameh*. Edited by Saeed Mir Sadeq and Abdul Hossein Navaei, First edition. Tehran.

Gurcistan Province Register Document as a Source for Research the History of Georgian and the Ottoman Empire

The Gurcistan Province Registers Document (Gurcistan Province Registers Document, I-III, 1941, 1947, 1959) was established in 1595 during the reign of Mehmed the 3rd for the conquered South-Eastern parts of Georgia. The document comes in several parts and consists of the Turkish texts, their translations, and the research itself. The researchers found the translation of the Ottoman texts to the Georgian language quite difficult because the document is written using Siyakat handwriting which is very complicated to read. Siyakat handwriting was invented specifically for the purposes of protecting secret documents, for making these documents quickly, and for their support. Syakat writing was originally invented in Abbasid Iran and later it spread to Anatolia. In the 15th century, Siyakat writings are found in the administrative and financial documents of Ottoman Empire. This handwriting was later refined by Katibs of Mehmed 3rd (the conqueror) – Husami Rumi and Tajizade Jafer Chelebi. Not only is Siyakat writing is prominent for its originality, it also has distinctive writing manners for specific periods in history.

Keywords: History of Georgian and the Ottoman Empire

The Gurcistan Province Registers Document (Gurcistan Province Registers Document, I-III, 1941, 1947, 1959) was established in 1595 during the reign of Mehmed the 3rd for the conquered South-Eastern parts of Georgia. The document comes in several parts and consists of the Turkish texts, their translations, and the research itself. The researchers found the translation of the Ottoman texts to the Georgian language quite difficult because the document is written using Siyakat handwriting which is very complicated to read. Siyakat handwriting was invented specifically for the purposes of protecting secret documents, for making these documents quickly, and for their support. Syakat writing was originally invented in Abbasid Iran and later it spread to Anatolia. In the 15th century, Siyakat writings are found in the administrative and financial documents of Ottoman Empire. This handwriting was later refined by Katibs of Mehmed 3rd (the conqueror) – Husami Rumi and Tajizade Jafer Chelebi. Not only is Siyakat writing is prominent for its originality, it also has distinctive writing manners for specific periods in history. (Muhittin Serin, *Siyakat Islam Encyclopaedia*, v. 37 p.291-291). Taking the of regularity of Georgian phonetics into consideration, S. Jikia made a Turkish transcription and translated the text. The researcher compared geographical terminology to the terminology of old Georgian literary texts. By doing this, it became possible to restore lost Georgian geographical names. The researcher worked hard to read Georgian names with Turkish transcription. It is a known fact that conveying Georgian words with the Arabic alphabet is difficult. That is why most of the primary names are lost. The restoration of primary national names and their transcriptions from the Turkish language is the greatest achievement of the researcher. This research plays a crucial role in studying the history and toponymy of the southern part of Georgia. The document also gives us important information concerning the Ottoman fiscal system and the types of taxes. In it, we can see terms that are typical for Ottoman administrative system. In addition, it is a very important document in the polytrophic and linguistic point of view.

Mikhael Svanidze states in his publication that “Gurcistan Province” and “Childiri Province” are the same administrative units. The same theory is mentioned in the introduction of Childiri Province Cebe Dokument and also in his publication “ From the History of the Establishment of Childiri (Akhaltzikhe) Province” (“From the History of the Establishment of Childiri (Akhaltzikhe) Province,” M. Svanidze, Matsne #3, 1964) Administrative division Samtkhe - vSaatabago and its Social and Economic Situation according to the Gurcistan Province Register Document, M. Svanidze, TSU works, v. 121 pp. 291-308). M. Svanidze asserts that the “Gurcistan Province Register Document” was made before “Childiri Province Register Document.” In fact, the “Gurcistan Province Register Documents” is thought to have been useful when Ottomans conquered, described, and composed Kanun-Name for a certain territory of Georgia. After that, it was named the “Gurcistan Province Registers Document.” Throughout the times when Ottomans conquered various parts of Georgia, the term “Gurcistan Province Registers Document” has stayed unchanged. That’s why, in 1595, during the description of Childis Province Registers Document, the name of the document was not replaced, but stayed the same as the “Gurcistan Province Register Document.” In the same publication, the scholar demonstrates specific administrative depictions and differences of Samtskhe-Saatabago, contrary to Ottoman provinces.

Kanun-Name (the book of laws) is present as the introduction in the documents. There were various directives for Kanun-Name in Islamic states. According to the traditions of old Persia, the laws (and most importantly tax laws) were introduced to people from a prominent position. During the Mongolian times, Chingiz Khan had his laws known as “Yasa-i Kadim-i Cengiz Han Yarguname” which regulated military and political duties. The legislative tradition of these laws was used even during the reign of Kazan Khan, the governor of Ilkhanate. After conquering new territories, the Ottomans did not include any changes in these laws, and even at the times when they did, the changes were quite insignificant. We can see the resemblance in the Akkoyunlu

(Oghuz Turkmen) historical source – Uzun Hasan’s kanun-names – as well. It was operating in eastern Anatolia, on the current territories of Azerbaijan and Iraq. After the Ottomans conquered Iraq, Safavid Kanun-names was abolished and Uzun Hasan’s Kanun-names was set to work instead. Unfortunately, no orders regarding setting/removing these taxes by Ottoman governance exist to day. Only according to the later documents can we confirm the existence of the market taxes and the rules of Timari distribution. Moreover, the minting of Ottoman coin Akhchi had begun in 1328.(Osmanli Kanunnameleri , Omer Lutfi Barkan, v 1 p. 311)). Sultan Murad I (1362-1389), with the help of Rumelian Beylerbey, specified the possession of Timars. It was during the reign of Sultan Mehmed II (1432-1481) when Kanun-names were officially set to work. Mehmed II’s Kanun-names were thoroughly studied by Mehmed Arif(Kanun-Name I Mehmed Fatih, M. Arif, pp.9-32), but Kanun-names as the part of the document of Sinjak registers, are present after the reign of Beyazet II (1481-1511), before that we have them only as ferman and individual laws. The development and improvement of the Ottoman legislative system after Mehmed II is connected to the reigns of Suleyman Kanun (1520-1566) and Ahmed I (1603-1617). The book of Suleyman Kanun went through many changes and improvements and the laws of land ownership by Ahmed I, that indicated certain precedents of owning land and its taxation proved the existence of early marketplaces (Книга Законов Султана Селима А.С. Тверитинова р.4). It is also interesting to take into consideration Kanun-names by Selim the First (1470-150), which have been researched by A.S Tvertinova. The first ferman that indicated the importance of registering documents was published in 1536 by Suleyman Kanun. As Turkish researchers state, in the case of committing a crime “Siyasetname” was published regarding administrative laws, this Ferman was supposed to be part of Kanun-name, that consequently, would lay the foundation of invention Suleyman the First legislative system base (Mufassal Osmanlı Tarihi M. Cezar M.Sertoğlu p 782). Selim I complete Kanun-name is unfortunately lost. Tertinova suspects that existing document might be kept in

the documents of Manisa Kadias (Книга Законов Султана Селима А.С. Тверитинова). The author states that the initiative of the invention of the legislative base during the reign of Selim I is connected with the instillation of principles of the Ottoman ruling system for provinces, such as Kayseri, Rumi, Diyarbakir, Mardin, Urfa and so on, dated by 1516-1518. Consequently, according to Tveritinova's theory, the end of the formation of the Ottoman feudal structure is connected with the reign of Suleyman I and not the period of Suleiman Kanuns.

The primary reason for starting up Kanun-names was for Kazasker society to tax the peasants, regulate the distribution of Timmers and determine and regulate taxed amounts. In the case of any conflict between the governors, they were guided by the various points in Kanun-names. In the earlier periods, for example in the Ilkhan states, existed specific books for regulating taxes, called Kanun-i Memeklet (state law) (Halil Inalcık, İslam ansiklopedisi; Kanunname, 2001, v. 24 pp 333-334). The existence of similar documents comes from the the Abassid period. In the Ottoman Empire as well, Kanun-names were inseparable parts of the books. It was approved by Sultan Turga (Tugra – is a special signature of Ottoman Sultans) and was made into law. The oldest Kanun-name is present in the Bursa Sanjak registration book (1487). This Kanun-name included information regarding the taxing amount set to Timmar owners, land ownership, and the rules of giving hereditary rights regarding the ownership of lands. It listed the exceptions and requirements for releasing from the taxation. Sanjak Kanun-names were made by the sovereigns or judges in order to differentiate Timmar owners and peasants, tax-paying farmers and vakif (cleric domains) that were free of taxes. English researcher Heath Lowry does not agree with Halil Inalcık, who states that Kanun-names were written only for the purpose of differentiating of taxation from peasants and Timmar owners. Heath Lowry asserts that Kanun-name was an imperial legislative codex that included regulations of all types of tax-payers in the state. Consequently the researcher concluded the name and types of Kanun-names. The taxes made explicitly for

peasants were called kanunname-i reaya liva-i. The researcher indicated that most of the Kanun-names that were in the document were written for the citizens of that specific category, as most of the citizens of the empire were agricultural. The taxes for the city citizens were regulated by two types of laws: port taxes, iskele kanunname, for seaside cities (Halil Inalcık does not mention as the part of his works these types of kanun-names), the laws for regulating taxes coming from the markets: bac i bazar kanunnamis and the regulating laws made for different tribes living in the empire (Rumelya) kanunname-i yörükân Naldöken, Ofcabolu, Tanrıdat , Kocacık (The Ottoman Liva Kanunnames Contained in The Defter-I Hakaniö Heath W.Lowryö The Journal of Ottoman Studies II, 1981 pp 44-50). Heath Lowry as well does not agree with Halil Inalcık who stated that Kanun-names consisted of general, standard rules used by rulers and judges to settle issues of peasants and owners of Timaris. Heath Lowry states that Kanun-names were made precisely according to the originality of a region. There is another opinion regarding admitting kanun-names as inseparable parts of the book. After analyzing various documents, Heath Lowry states that there are no kanun-names in 40% of the document, but they are present in the various parts of the texts. The majority of the book consists of blank papers that are thought to be intended for Kanun-names ((The Ottoman Liva Kanunnames Contained in The Defter-I Hakaniö Heath W.Lowryö The Journal of Ottoman Studies II, 1981 pp 52-54) Sanjak kanun-names can be divided into several groups geographically: Anatolia Provinces and Bursa kanun-names and on the other hand east region of Anatolia – Malatia, Diarbakir, Erzurum, Musul, Harfut and Mardin. Kanun –names of Rumelia Sanjak are part of another category, there we see the mixture of Ottoman, Byzantian and Slavic states. We see different points about Reayas and Sifahies and representatives of Kazasker society (İslam ansiklopedisi;2001; v.24 pp335).

Omar Lutfi Barkan published the information regarding Kanun-names written in the book in the collection of Ottoman Kanun-names in 1943 (XV ve XVI nci asırlarda Osmanlı İmparatorluğunda Zirai Ekonominin hukuki ve mali esasları,

Ömer Lütfi Barkan, V. 2, Kanunla, 1942). The book of law states the rules of taxation of Reaya, different types of duties, the rules of assigning Timar and so on. The Ottoman tax system is divided into several parts: Rusum-i, Sheria- taxes, which are made based on Shariat (Zekat, Kharaja, Jizya) and Takalif-i, urfiye- which are based on tradition (Avariz) (History of Turkey, M. Svanidze, 2007, p.83). Based on the book of laws, we will show the essence and content of certain taxes.

Isfench **یسفنج** is a tax set on non-Islamic citizens that consisted of 25 Akhchas. As it is written in the book of laws: "After paying this tax, the payments of farm duties, half duties and Donum are not required (Gurcistan Province Register Document, S. Jikia, v II)." The oldest data regarding Isfench tax is dated to the reign of Bayazit I and content-wise, it has the same load as in our case, the taxation of non-Muslim males and is equal to 25 Akhchas (İspence, Halil İnalçık, İstanbul, 2001). Isfench taxes are more frequent after Suleyman Kanun's conquer of Siberia, though this tax is not as frequently seen in the regions of West Anatolia. Moreover, there is no evidence of these taxes in the documents of Anatolia and Arabic provinces. After East Anatolia and the south-west province of Georgia, Samtskhe-Saatabago, was conquered by the Ottomans, they actively started taxing population with Isfench tax. Isfench specifically for non-Muslim citizens, and the same tax content-wise called Resmi Chifti (Osmanlılarda Raiyyet Rüsümü, Halil Inalcik, Belleten, Ankara 1959, v. XXIII) was set for Muslims. This theory was shared by I.H Uzuncharshili and O.L Barkan. N. Shengelaia, when speaking about Isfench taxes, gives an example of the theory of Derzhavin , according to whom, Isfench tax was a fee set to collect Yanichar army by Christian children of Bulgaria that would be taken for every five years (Ottoman Taxes according to the Gurcistan Province Register Document, TSU works, v 91, 1960). G. Tivadze states that Isfench was taken instead of paying the expense, and it entailed tax on the Christian population instead of military services (Samtskhe Saatabago, Tivadze). The book mentions the names of a number of people and the final amount of Isfench based on Livas.

The next taxing system mentioned in the document is called Bennak **بناك** (Origin comes from Persian term bil and nak, in Turkish belnak, belnak>benlak>bennak). The total amount of this tax is relatively less, as Bennak is a tax set on Muslim citizens. As F. Emejen asserts, Bennak is a tax on a married Muslim and unmarried Muslim pays Mucerret tax (İslam Ansiklopedisi ,v 5, pp 458-459). It may be because of this as N. Shengelaia asserts, the book has mixed taxes of Mucerret and Bennak. D. Tivadze states that Bennak was paid by Muslims who were not in the military. By another definition, Bennak was a payment set for married couples that did not have a Chiftlik (farm). In the book of laws, Bennak tax has 18 Akhchas. The largest amount of Bennak was set for Fanaki Liva and the least amount was for Akhaltsikhe Liva (Ottoman Taxes according to the Gurcistan Province Register Document, TSU works, v 91, 1960). In the Ottoman taxing system, we see two types of Bennaks: Caba bennak and Ekinlu (ekinlü). Peasants who had less than a half of a land paid Ekinlu bennak, whereas married peasants who had no land paid caba bennak. These types of peasants worked on lands of others and in return paid Donum resmi (İslam Ansiklopedisi v 5, pp 458-459). Donum is one of the taxes set for land ownership. The book of Kanun names states about Donum taxes as well: "If peasants comes from another province and based on Tapu will plough and plant the Sipahi's (landowner land, than after paying set Behre tax, one akhcha will be taken from better two donums, whereas one akhcha will be taken from three worse donums. Donum, by length and width is not more or less than 40 regular steps of land. It is set by law, that cropland of reia that has been left for three years without cultivation will be taken from the owner on the bases of Tapu and will be given to someone other."(Gucrisran Province Register Document, S. Jikia, v.2, p. 2)

In Georgian Vilaliet, a peasant who paid isfenji, was free of paying Resmi Donum tax. Chifti (**çift resmi چيفت رسمي**) tax is set to a landowner peasant every year. This Chifti akcha contain the least amount of 22 akhchas and the most amount

of 57 akhchas. Non-muslim population paid isfenji tax instead of Resmi chift tax, non-muslim Georgians did not pay Chift resmi as well. The book of laws states that peasant does not pay chifti tax. N. Shengelia asserts that the Ottoman conquerors might have compromised, but in return heavily taxed the population.

Another tax that is discussed in the document that has gained the attention of many researchers is Tafu fee (تاپو). Tafu was taken when land was passed from one owner to another (History of Turkey, M. Shengelia, 2007, p. 80). In the case of Tapu fee, the peasant had to cultivate the land. According to V. Gabashvili Tafu was a written form of land-tenure and the payment of profit (Georvian Feudal orden in XVI-XVII cc, V. Gabashvili, 1958, p. 217). The kanun names of the document mention tapu taxes as well: "If somebody dies in Reaya and has no land left, the land is passed to the child, as inherited possession. If the person does not have any children, the land does not pass to the bother. Instead, it obeys Tapu's rules. But if the brother pays the tapu taxes that others pay, the land will not be passed to other person (Gucrisran Province Register Document, S. Jikia, v.2, p. 1) Tapu tax depended on the quality of the land, because of this the amount of fee was merging between 40-30 akhchas and in case of small lands 20-10 akchas (History of Turkey, M. Svanidze, 2007, p. 80). The tax of tapu and deshtiban is frequently mixed and mentioned together.

Besides the tapu fee, the book of laws mentions murakhasiye tax, (the word is pronounced differently in Turkish authors some use markhasiye some murrakhasiye, Georgian scientists V. Gabashvili and N. Shengelia use murrakhasiye). According to Ottoman book of laws this is a tax taken from non-muslim impropiators, though these people don't play Jiziye fee (Osmanlı Müesseseleri Tarihi , Mehmet Ünal İsparta, 1997 pç 165) In the east Anatolia Armenian peasants paid Jizia Markhazia, same as murrhhasiye, in this case they were free of isfench fee (1540 Hç 947 Tarihli Kanunnamelere göre Musulö Amıd ve Erzurum Sancaklarında Zırai Gelirlerin Mukayeseli Tahlil ,Unal Taşkıım, p 8) .

The document states: “based on murrhasiye tax mentioned in Gurjistan document, each person was taxed on two akhchas. According to a note written in the new Sultan book, in order to facilitate reia state, each household should have been taxed not more than two akhchas” (Gurcistan Province Register Document v 2. P.4).

In the document, we frequently come across Badhava (bad i hava بادى هوا) and marriage taxes. We see definition in the book of laws: “marriage fee (“arus resmi” mentioned in kanun-names as resm-i arus, arü- siyye, arüsane, gerdek resmi, arab.arus means - bride) is taken from 60-60 brides and 30-30 widows if they live on the territory of Mirliva. In the case of the marriage tax for timar owners, they took half on Siphahie places, whereas the other half on Mirliva places was taken by Sanjak military leaders. The marriage fee of a girl, no matter where she was getting married from, is paid by a father for a person whose reia she is becoming. Widow pays timar fee to a person that owns land where she lives(Gurcistan Province Register Document, S. Jikia, v 2. P.3). Yoruks (Turkish tribes living in Anatolia and Rumaliya(Yörükler İslam Ansiklopedisi, Faruk Sümer, p 570) who were assigned separately, did not have permanent homes. Thus they were taxed with the same amount on widows and brides. Bad-i hava tax consisted of several fees: taxes, marriage fees, tafu and household fees.

The Ottomans also set taxes on valleys and kishlags, (kışlak vergisi, resm-i yaylak). Pastures were taken into consideration as well. The book of laws states: “processing and fencing those pastures that indigenously were fenced by town residents, or those who were used by villagers and castle residents was prohibited” (Gurcistan Province Register Document, S. Jikia, v 2. p.2). The tax set on the valleys was one sheep out of 300. It was taken by timari owner or mültezim (same as iltizam- a person in Ottoman Empire who had to collect taxes (İslam Ansiklopedisi , Mehmet Genç, 2000 v 22, pp 154-158) in January. The Ottomans also had overwinter taxes, which consisted of six akhchas on married

reia and three akhchas on sole reia, in the case of processing the land, reia did not have to pay overwinter fee.

The book of laws also mentions tax on herds, (*resm-i ağnam*) one akhcha was set on two sheep. Moreover one akhcha was set on every ten sheep. The book of laws mentions sheep-fold fee: "medium sized sheep should be taken from each herd, and if the amount of sheep is less than herd, one akhcha should be taken from every ten sheep (Gurcistan Province Register Document, S. Jikia, v 2. p.3)". The book does not mention anything about the amount of fee on pigs. This same tax set on the non-muslim population in the Ottoman empire is written as *resm-i hınzır* and entailed one akhcha fee on a single pig. In some kanun names it reached 2.5 akhchas (Ottoman Taxes according to the Gurcistan Province Register Document, N. Shengelia, TSU works. V. 91, 1960, p. 298). The amount of fees paid for pigs was much higher than fees paid for sheep, which was meant by Ottomans to demolish this species.

In the document, we come across Oshur (*öşür*) taxes. It was taken for gardens, vineyards, vegetable gardens and so on. As crops was highly spread in Georgia, according to the 1/3rd part of the document, these fees were taken. The tax was determined by Qile (weighting unit of crops). In Sanjaks, sometimes one Qile of wheat was 12 akhchas. In other places, it was ten akhchas. Additionally, the amount of other types of crops such as barley, rye, flax seeds and millet was determined by Qile as well. Oshur tax was also set on bees, fishing, and obtaining mills.

Not only has the document given us information regarding taxes, but also it informs us regarding the originality of the Ottoman ruling system. The document mentions administrative units of Vilayet: Sanjak (*liva*), Nihaye, village. In the Vilaiet of Akhaltsikhe, there were eight Sanjaks and 28 nihayes within them (Gurcistan Province Register Document, S. Jikia, v 2. p.6-11). Official state terms seen in the document include: Begi, Pasha, Serasker, Mirmiran, Belarbeg, Vizier,

Sanjak-beg, Mirliva, Miralai, Mirialem, Yenichar, Sipah, Dizdar, Yuzbash, Chavush, Subash, Emin, Qatib, Ketkhuda, Kadi, and Muezin..

In the head of Eialet was Belarbeg, the same as Mirmiran. After him was the Sanjak-beg (same as mirliva) who ruled a Sanjak. His duties also included mobilization of Timari owner Sipahies for the war. Subashes were representatives of Sanjak-beg in Nihaye.

Kadies were actively involved in ruling Sanjaks, who managed the court according to Shariat. This term, coming from Arabic, entails executing and agreeing on arguments. In Ottoman Turkey, Kadias had legislative and administrative powers. The institute of Kadias was divided into two parts. On the higher level were mevlev kadias (mevleviyet kadılıkları –mevleviyet – the term used for the highest cast of Kadias) and Kazi Kadias (kaza kadılıkları) (Islam Ansiklopedisi pp. 467-468)). The term “kad” is first seen in the period of Osman Gaz. According to the source of Ashik Pashazade we find that after conquering Bilejik some Turkun Pakih was appointed, and he read khutba for Osman Gazi. In the period of Sultan Mehmed II, the civil and administrative division is beginning to form. During his reign, the kadi hierarchy is mentioned in kanun-names. Kadias were appointed on the basis of Sultan’s Berrat. Anatolian and Rumelian Kaziaskers managed the appointment of kadias. Clerical work was happening in Rusmane department. If the appointment of any kadia was not demonstrated in the document, the berrat would lose all its powers (Islam Ansiklopedisi p. 66-73). Before the 15th century, Kadia’s salaries were quite small, so bribery was widely spread. During the reign of Mehmed the II, Kadia’s salaries were increased. The people who had studied in Medrese and had worked at Divan, were appointed as kadias. Others who were doing educational activities in Medrese were appointed in Kaza as kadi. For example, people who had been working for 20 years doing educational activities were appointed as kadias with the salary of 45 akhchas. The kadias who had a length of service in Hagia Sophia medrese, were on the highest level and were appointed as kadias

of Elaiet were called taht kadılığı or mevleviyet and had a salary of 5,000 akhchas. Kadias who had salaries of 300 akhchas were assigned as Devterdars. The others who had salaries of 500 akhchas were assigned as beglarbeks, who were kadias passed to Asket class. In the 15th-16th centuries at the council of Divan, kadias were appointed as Kaziskers (highest military judges) of Rumelia and Anatolia as Padishah presented and approved them. This form of assigning Kadias changes after the reign of Mehmed the II, and the grand vizier was the one who approved them. Whereas in the 16th century kadias of the mevleviet class were approved by grand vizier on the basis of the agreement of Shehulislam. Kadias had their own trusted people in the court who were called naibi (nâib - نايب), depending on the size of kaza (Administrative unite governed by Kadies), the court could have more than one naibi, kadias also had one more assistant "kassam" who had to distribute belongings of the late. Before the end of 16th century, in every Sanjak and eialet existed so-called mobile kadias. They heard and decided arguments between villagers, Sanjakbeks, aliabeks, subashes, zeamets and timati owners (, XIV-XVII YY. Osmanlılarda Devlet Teşkilatı ve Sosyal Yapı, Yusuf Halacoğlu 1991 pp 90-112).

Vilaiyet had miralay (the higher post of military), chavushes. In general these officials were considered as subordinates of alay-beg. Cheribashes- also known as higher posts of military officials were after alay-beg, whereas dizdars were fortress commanders.

The document also mentions Emin and Ketkhud, Subash and Zaimb. In the book of laws where it states about charging a punishment for some crime, Sanjak-beg and Subashes are included in the investigation of a crime. "Sanjak-beks and Subashes are prohibited in arresting a criminal and take something from them and free them without investigating a crime until the crime is proved by vilaiet kadi. ... Sanjak beks and subashes should not walk in the community with many guides and should not take anything without money" (Gurcistan Province

Register Document, S. Jikia, v 2. p.5). Subash meant military leader. He was responsible for the security of kazas in sanjak.

The book mentions Imams, bishops, and monks, from financial officials: Emin, document ketkhud and katib. According to the document, Emins were working in the sakhaso of Sultan, whereas at the places belonging to Sanjak-beg worked Sinjak military leaders (maybe subashes) (Gurcistan Province Register Document, S. Jikia, v 2. p.4) The lowest social class reia (reaya - راياء)- peasants, was a general name for reaya-tax paying class, though in kanun-names city residents are mentioned as a separate group. In kanun-names, for example, city residents do not pay Chiptlik fee, but if they possess the land on the border of the city- they pay the fee.(Islam Ansiklopedisi p. 490-493) Except for the set taxes, peasants also had to take care of roads, fix bridges, and transport goods.

Gurjistan registers document is the best document indicating Ottoman fiscal and local ruling organization. After researching the document, it is clear that Ottoman conquerors maximally tried to take as many fees from populations as possible to satisfy the state's growing needs. Though it should be noted that during some period in time, Georgian landownership rules were under Ottomans influence In the end, Ottoman rules for land ownership and using a land wholly demolished it and these rules had to shift to their own (Исторический очерк турецкой системы землевладения Д. Бакрадзе р. 29). It is clearly shown in the document that the Ottoman taxing system had a specific approach to the Christian population. It was taxed with a higher amount of fees than Muslims. At the end of the 16th century, Samtskhe fully became influenced by the Ottoman ruling system. The majority of the population became Muslim and others who did not change religion had to run to other parts of Georgia. As V. Gabashvili states, "this document is the only literary text that least considers the originality of Georgian feudal system." (Geordian Feudal Orden in XVI-XVII cc, V. Gabashvili. 1958, p. 344)

References

1. ჯიქია ს. „გურჯისტანის ვილაიეთის დიდი დავთარი“, I-III 1941,1947,1959 წ.
2. Serin Mühittin, İslam ansiklopedisi, Siyakat ტ. 37
3. Barkan Ö.L. Osmanlı Kanunnameleri 1950, ტ.I
4. Arif M. Kanun-Name-i Ali Osman 1330, İstanbul
5. Тверитинова А.С. Книга Законов Султана Селима; 1969
6. Sertoğlu M. Cezar M.; Mufassal Osmanlı Tarihi, Istanbul; 1957
7. İnalçık Halil, İslam ansiklopedisi;, Kanunname, 2001; ტ. 24
8. ჯიქია ს.; თსუ შრომები#91
9. Lowry Heath. The Ottoman Liva Kanunnames Contained in The Defter-I Hakani; The Journal of Ottoman Studies II, 1981
10. Barkan Ö.L XV ve XVI nci asırlarda Osmanlı İmparatorluğunda Zirai Ekonominin hukuki ve mali esasları. Inci cilt, Kanunlar, 1942
11. სვანიძე,მ. თურქეთის ისტორია, 2007
12. İnalçık Halil,Osmanlılarda Raiyyet Rüsümü”, Belleten, Ankara 1959, c. XXIII
13. შენგელია ნ.ოსმალური გადასახადები და ვალდებულებანი „გურჯისტანის ვილაიეთის დიდი დავთრის“ მიხედვით“ თსუ შრომები, ტ. 91, 1960
14. ტივაძე გ., სამცხე -საათაბაგო /სამხრეთ საქართველო / თურქ დამპყრობელთა ბატონობის ქვეშ და რუსეთის როლი მის განთავისუფლების საქმეში : დისერტაცია; 1950
15. ვ. გაბაშვილი „ ქართულის ფეოდალური წყობილება XVI-XVII სს. ში ; თბ. 1958 წ.
16. Yusuf Halacoğlu, XIV-XVII YY. Osmanlılarda Devlet Teşkilatı ve Sosyal Yapı, 1991

Metreveli Archil

The University of Georgia

The freedom of Personal Self-Determination as the Prime Principle for "The Religion or Belief Manifestation Test" in ECHR Case-Law

Abstract: This article focuses on the case law under Article 9 of the ECHR in the field of classifying an act as a manifestation of a particular religion or belief. It aims to criticize the long-time rigid practice of the European Commission and the European Court, which grants them the Power of Assessment in this regard. Namely, in the light of the general principles of the freedom of religion and belief, the author explains why it is natural and necessary for the Court to give up its Power of Assessment and leave the issue entirely in the scope of personal self-determination. In arguing own view, the author relies upon the Court's approach developed in the Case - Osmanoglu and Kocabaş v. Switzerland (ECHR. 2017).

Keywords: Freedom of Religion and Belief; Manifestation of Religion or Belief; Individual Dimension of the Freedom of Religion or Belief; Freedom of Personal Self-determination in choice of Religion or Belief and their Manifestation Forms.

In 2017, the European Court of Human Rights (hereafter "the Court") delivered final judgment on the Case - Osmanoglu and Kocabaş v. Switzerland (29086/12.10/01/2017). In this case, the applicants, who were Muslims, were required to have their daughters exempted from compulsory mixed swimming lessons at their primary school on religious grounds. Although the Swiss Government refused their request, the applicants continued to resist. Accordingly, the national authorities imposed fines on them. The Court held that there was an interference in the parents' right to freedom of religion or belief on the part of the State. Namely, although the parents' resistance was not directly derived from the Koran, it still was undoubtedly motivated by their sincere faith. While there was a legitimate aim to restrict applicants' rights, the Court undeniably proved a precedential approach. Previously, the European Commission of Human Rights (hereafter "the Commission") and the Court, in such cases, usually used the so-called "Arrowsmith Test" (with minor modifications). The test considers that the manifestation of the religion or belief ("practice") does not cover every act, which is merely motivated or influenced by a religion or a belief but only those, which actually express the religion or belief in question. In the present case, the Court essentially argued that to recognize an act as the manifestation, it is not always necessary the direct accordance with the conviction, in question and person's sincere faith that he or she is acting in accordance with own belief is also sufficient.

Precisely this same approach revealed by the Court, in the Case of Osmanoglu, is the inspiration of the present article, which urges us to analyze and criticize the formation and development of "The Religion or Belief Manifestation Test"⁸³ (hereafter "the Manifestation Test") entirely.

⁸³ The practice of the Commission and the Court to assess whether or not the particular act represents an actual Manifestation of the religion or belief, in question.

The author describes and discusses all the objective conceptions on which is or should be based the freedom of individuals to determine their social behavior and relationships freely, without any interference and according to own faiths solely. Based on this theoretical foundation, the author develops the attitude that when classifying a particular act as the manifestation, the Court should finally give up its power of assessment and leave the issue entirely in the field of personal self-determination.

General principles

Religious conviction is one of the most important foundations for sincere believers in personal self-understanding, perception of the universe, and determination of their relationship with it. In other words, religious convictions, on the one hand, shape the inner identity of the believer and, on the other hand, define their outward behavior. Usually, one's social life and personal relationships, shaped by religious convictions, are not merely subjective interpretations of religious concepts but strict and direct obligations. Hence, every person must be free to express their inner convictions, including in the forms they consider appropriate, without unjustifiable interference from other individuals or the State.

1. Two dimensions of the freedom of religion or belief

Universally, the freedom of religion or belief recognizes and protects the right to *hold* (Forum Internum) religious conviction, as well as the right to *manifest* it (Forum Externum). Thus, the freedom of religion and belief combines two dimensions - *Internal* and *External*.⁸⁴ In discussing these dimensions, apart from

⁸⁴ UDHR Art. 18; Convention Art 9; ICCPR Art 18.

their proprietary content, the most important issue is the difference between their *absolute* and *non-absolute* natures. In particular, according to Article 9 of the European Convention on Human Rights (hereafter the "Convention") and Article 18 of the International Covenant on Civil and Political Rights (hereafter the "ICCPR"), the *Internal Dimension* is an absolute and unrestricted right but its *External Dimension* - is not. Hence, the freedom to manifest a religion or belief shall be subject only to such limitations as are prescribed by law and are necessary for a democratic society in pursuit of one or more of the legitimate aims.⁸⁵

Notwithstanding this fundamental difference, the essential separation of the *Internal* and *External* dimensions of the freedom of religion and belief is impossible. Moreover, the external behavior and relationships of the believers are formed by the influence of their inner faith, and on the contrary, the ability or disability of free manifestations of inner faith necessarily affects the internal dimension of their belief.⁸⁶ Consequently, the fundamental separation of these dimensions makes meaningless both of them, since, as far as it is impossible to separate a particular religious practice from the religion in question, it is also impossible to separate the freedom of manifestation of religion from the freedom to hold it. Therefore, legislation or practice that recognizes and protects only the freedom to hold a religious conviction and not, at the same time, the freedom to manifest it, is not a mere violation of the *External Dimension* of this freedom but also represents a gross intervention in the person's inner world and directly or indirectly impacts on his or her personal identity. The same applies to undue interference with the exercise of the freedom of manifestation of religion or belief, which limits or abolishes one's freedom to live and relate according own conviction.

⁸⁵ Convention Art 9 (2); ICCPR Art 18 (3).

⁸⁶ KOKKINAKIS v. GREECE (14307/88. 25/05/1993). § 31.

2. The classical forms of religion or belief manifestation

All of the international norms set forth above explicitly describe the generally recognized forms by which one may manifest own religion or belief (individually or collectively and in public or in private), in particular, *worship*, *teaching*, *observance*, and *practice*. When discussing the essence of these forms, it is important to answer fundamental questions: does this list have *circumscribing* or *broadening* intentions?

First, it must be underlined that worship, teaching, observance and practice are interpreted broadly but not exhaustively and cover wide-ranging acts based or motivated by religion or belief.⁸⁷ Furthermore, it is of primary significance that the Court's case-law, under Article 9 of the Convention, does not include an exact and exhaustive definition of these terms. In the absence of general definitions, the Court always seeks to determine whether a particular action represents one of them. However, even in such a case, its purpose is not necessary to classify the action into only one of the four forms. Therefore, often one action corresponds not only to one, but to two or three forms of the manifestation.⁸⁸ This indicates that the Court defines the forms of the manifestation through some practical experience and does not rely upon the preliminarily considered exact and exhaustive concepts. Thus, the Court, in principle, is not closed to

⁸⁷ See: UN Human Rights Committee (HRC), CCPR General Comment No. 22: Article 18 (Freedom of Thought, Conscience or Religion), 30 July 1993, CCPR/C/21/Rev.1/Add.4. § 4. And UN Declaration on the Elimination of All Forms of Intolerance and of Discrimination Based on Religion or Belief (1981). Art. 4.

⁸⁸ Cf.: KUZNETSOV AND OTHERS v. RUSSIA (184/02. 11/01/2007). § 57, KOKKINAKIS v. GREECE (14307/88. 25/05/1993). § 31, EWEIDA AND OTHERS v. THE UNITED KINGDOM (48420/10, 36516/10, 51671/10, 36516/10. 15/01/2013). § 89, JAKÓBSKI v. POLAND (18429/06. 07/12/2010). § 45. Etc.

recognizing such act as the manifestation which has not yet been practiced but actually represents the manifestation of one's religion or belief.

While the Court continuously examines all particular acts independently as to whether it is placed in one or more of the four recognized forms, it is clear that an exact and exhaustive understanding of the content of these forms could not exist even during the elaboration of the Convention (as well as the UDHR and the ICCPR). Thus, their statutory fixation, given the Convention's (as well as the UDHR's and the ICCPR's) human rights spirit, should have been more of a Broadening intention of the right, rather than the Circumscribing one.⁸⁹

3. The impossibility of exact and exhaustive definition of the "Manifestation Forms"

Significantly, no International Act protecting the freedom of religion and belief includes the definition of the terms "religion" or "belief." On the other hand, all competent definitions of these International Acts grant the broadest content to these terms.⁹⁰ Furthermore, the legal definition of these terms is also inappropriate at the national level.⁹¹ The absence of such definitions is quite rational since, in addition to the general absence of a homogenous and universal understanding of these concepts, it is expressly important that the existence of such a strict definition would be essentially inexpedient. In particular, it would

⁸⁹ The Broadening intention of these forms is directly emphasized through the Study of Discrimination in the Matter of Religious Rights and Practices. Arcot Krishnaswami. Special Rapporteur of the Sub-Commission on Prevention of Discrimination and Protection of Minorities. UN. New York. 1960. p.17.

⁹⁰ For the UDHR see Arcot Krishnaswami. 1960. P 1. (Footnote 7), For the Convention - Guide on Article 9 of the Convention - Freedom of thought, conscience and religion. European Court of Human Rights. Updated on 31 August 2020. § 14, For the ICCPR - General Comment No. 22: Article 18 (Freedom of Thought, Conscience or Religion). § 2.

⁹¹ Guidelines for Review of Legislation Pertaining to Religion or Belief. OSCE. ODIHR. (2004). II.A.2.

resist the goal of the freedom of religion and belief, which intends to embrace any religious convictions to ensure that all believers have the right to freely adopt and practice any religious convictions, which they confess by their inner faith, based only on their personal choice. Thus, on the one hand, the absence of the legal definition of the terms "religion" and "belief" and on the other hand, the absence of an exact and exhaustive definition of the terms "worship," "teaching," "practice" and "observance," equally point to the primary broadening intention of both dimensions (internal and external) of the freedom of religion or belief.

The above consideration relates to the problem of legal and conceptual understanding of the terms "religion" and "belief." However, this problem does not have only this dimension. It also involves a principle of logical confrontation. In particular, the rule of logical reasoning first implies a precise understanding of the core doctrines (religion or belief) to properly understand their consequent concepts (worship, teaching, practice, and observance). In this sense, it is virtually impossible to argue that the national authorities or the Court have any power or competence to define whether an act is an actual manifestation of religion or belief in question. Since in the absence of a legal definition of religion or belief, they cannot rely on any legal basis in their decision-making, as they operate predominantly in the scope of legal categories.⁹² This logical dilemma is also evident from a reversed perspective. In particular, it is difficult to guarantee that the national authorities or the Court in assessing any act as the manifestation of particular religion or belief will not assess the religion or belief itself and, nevertheless, be able to prove objectively that they are in direct and close nexus with them. Assessing a link between the

⁹² Cf. MANOUSSAKIS AND OTHERS v. GREECE (18748/91. 26/09/1996). § 41.

conviction and the act, considering the diversity of the religions and beliefs protected by the freedom of religion and belief, is extremely difficult.⁹³

Summary of General Principles

The reasonings and arguments developed above can be summarized as follows:

1. The freedom of religion and belief is a consolidated right that integrally includes both internal and external dimensions. Thus the ability or disability of a person to freely manifest their own religion or belief and to form and practice corresponding social relationships and behaviors necessarily has a direct influence not only on the external but also on the internal dimension of his/her freedom of religion and belief;
2. The classical forms of the manifestation of religion or belief – worship, teaching, practice, and observance – do not have a precisely established exact and exhaustive understanding. They are broadly interpreted and intended to extend rather than limit the freedom of religion and belief;
3. The fact that the terms "religion" and "faith" are not subject to legal definition in itself creates a logical problem of the legal definition of the forms of their manifestation.

All of this indicates that the right to *manifest* a religion or belief, likewise the right to *have* a religion or belief, is a matter of a genuinely subjective personal self-determination. Therefore, national authorities and the Court, which have

⁹³ For example, the organs of the Convention (namely, Commission) has experience when, in deciding, whether the restriction on the right to manifest one's religion was justified, had to discuss if the religion in question was identifiable itself. Cf. X. v. the UNITED KINGDOM (7291/75. 04/10/1977).

not, in principle, any competence to assess the essence of this personal sphere, cannot, in principle, hold any power to assess its legitimacy. This preliminary conclusion will be the guidance we will rely on in the second part of this article.

"The Manifestation Test" – the Practice of the Organs of the Convention

While the arguments discussed in the preceding chapter, in principle, fully protect the right of personal self-determination in the choice of forms of manifestation of their convictions, the practice of the Organs of the Convention in this respect still seems to be contradictory. This part of the article aims to describe, analyze, and criticize this practice.

1. *Arrowsmith v. the United Kingdom*⁹⁴

In 1978, the European Commission of Human Rights delivered a decision on a case where the applicant was a United Kingdom citizen. She was a pacifist who urged British soldiers to leave the military service and not go to war in Northern Ireland. While the applicant could prove her pacifist beliefs, she could not prove that the "practice" of handing out relevant leaflets to soldiers was a legitimate manifestation of her beliefs and not an act merely motivated by her belief. British courts convicted her and sentenced her to imprisonment. The applicant submitted a complaint to the Commission and claimed a violation of her freedom of belief under Article 9. The Commission accepted that Article 9 covered the applicant's belief but distributing leaflets did not constitute a "practice" of Pacifism because it seemed political opposition to a particular government policy. The Commission interpreted a distinction between acts, which are

⁹⁴ *ARROWSMITH v. THE UNITED KINGDOM* (7050/75. 12/10/1978).

"merely motivated or influenced by a religion or belief," and the acts, which actually "manifest" the belief in a "practice." The "test" focused upon whether a particular manifestation is necessary in order for someone to practice personal belief (in which case an exemption is available), as opposed to situations in which the act in question is simply inspired by personal belief (in which case an exemption is unavailable). The Commission noted that not every act motivated or influenced by a belief will suffice to be a "manifestation" and ruled that there was no "Manifestation."⁹⁵

This precedent has become so-called the "Arrowsmith Test," according to which the "manifestation" of religion and belief does not "cover" every act which is merely motivated or influenced by a religion or a belief, but only those that "actually express" (or is "intimately linked" to) the belief in question. The Organs of the Convention repeatedly used the Arrowsmith Test" in different variations.⁹⁶ It is remarkable that in parallel with this test, the Organs of the Convention adopted a different approach in several cases. In particular, they have replaced the term "does not cover" with the term "does not protect," which would substantially change their approach.⁹⁷ Because, in contrast to the principle that the manifestation does not "cover" any act motivated or influenced by the religion or belief in question, it is principally correct that the right to manifest a religion or belief does not unconditionally protect any act, including the classical forms of the manifestation, such as "worship, teaching, practice, and observance." Nevertheless, the approach of the Organs of the

⁹⁵ *Ibid.* § 71.

⁹⁶ Cf: *C. v. the UNITED KINGDOM* (10358/83. 15/12/1983); *VERENIGING RECHTSWINKELS UTRECHT v. THE NETHERLANDS* (11308/84. 13/03/1986); *VAN DEN DUNGEN v. THE NETHERLANDS* (22838/93. 22/02/1995); *PORTER v. THE UNITED KINGDOM* (15814/02. 08/04/2003). *PRETTY v. THE UNITED KINGDOM* (2346/02. 29/04/2002); *PICHON and SAJOUS v. FRANCE* (49853/99. 02/10/2001); *SKUGAR AND OTHERS v. RUSSIA* (40010/04. 03/12/2009).

⁹⁷ For example: *KALAÇ v. TURKEY* (20704/92. 01/07/1997). § 27. see also *LEYLA ŞAHİN v. TURKEY* (44774/98. 10/11/2005). § 105;

Convention did not change substantially, and the right to choose a precise form of the manifestation did not remove in the sphere of personal self-determination of individuals (or even communities). The fundamental problem of the Arrowsmith Test –imposing the burden on the applicant to prove that a particular act is a direct and obligatory requirement of a particular religion or belief – has remained unchanged for a long time.⁹⁸

2. Eweida and Others v. the United Kingdom⁹⁹

The Arrowsmith Test was significantly extenuated, but not radically changed in 2013. In the present case, two applicants – Ms. Eweida and Ms. Chaplin – complained that their employers had placed restrictions on their visibly wearing Christian Crosses at work. Two other applicants – Ms. Ladele and Mr. McFarlane – complained that they had been dismissed for refusing to carry out certain duties which they considered incompatible with their religious beliefs. In this case, the Court made extensive and modified interpretations of the essence of the connection between religion and belief and the forms of their manifestation. In particular, the Court noted that in order to count as a "Manifestation," the act in question must be intimately linked to the religion or belief. Furthermore, the existence of a sufficiently close and direct nexus between the act and the underlying belief must be determined on the facts of each case. In particular, there is no requirement on the applicant to establish that he or she acted in fulfillment of a duty mandated by the religion in question.¹⁰⁰

⁹⁸ Other authors earlier also criticize this approach, for example, cf: Uitz, R. (2007) *Freedom of Religion in European Constitutional and International Case Law*, Strasbourg: Council of Europe Publishing, pp. 28-29.

⁹⁹ EWEIDA AND OTHERS v. THE UNITED KINGDOM (48420/10, 59842/10, 51671/10, 36516/10. 15/01/2013).

¹⁰⁰ *Ibid.* § 82.

Thus, the Court identified two important aspects. First, the Court has retained that part of the Arrowsmith Test which excludes from the "manifestation" acts which are in some way inspired or influenced by the religion or belief in question but do not directly express it or which are only distantly connected to it. Second, it extenuated the applicants' burden of proof by stating that there is no requirement on the applicant to establish that he or she acted in fulfillment of a duty mandated by the religion, in question".¹⁰¹ While the latter was a quite significant modification, the maintenance of the first aspect still left the problem of recognition of the freedom of personal self-determination in connection with the acts motivated by personal beliefs.¹⁰²

3. Hamidović v. Bosnia and Herzegovina¹⁰³

The Court has revealed a principally new approach to classifying an act motivated or inspired by personal beliefs as "manifestation" in 2017. In the present case, a Muslim applicant was called to give evidence at the criminal trial. He duly appeared at the trial as summoned but refused to remove his skullcap when asked to testify, arguing that it was his religious duty to wear it at all times. He was expelled from the courtroom, convicted of contempt of court, sentenced to a fine, and later was sentenced to imprisonment for his principal non-payment. The applicant submitted a complaint before the Court under Article 9. The parties agreed that the punishment imposed on the applicant for wearing a skullcap in a courtroom constituted a limitation on the manifestation of his religion. This is in line with the official position of the Muslim community in

¹⁰¹ The Court followed very similar approach in the case S.A.S. v. FRANCE (43835/11. 01/07/2014). § 55.

¹⁰² Other authors earlier also mentioned this *modification*; for example, cf. Slotte, P. (2015) International law and freedom of religion and belief: Origins, presuppositions and structure of the protection framework. Routledge Handbook of Law and Religion. Edited By Silvio Ferrari. p. 109.

¹⁰³ HAMIDOVIĆ v. BOSNIA AND HERZEGOVINA (57792/15. 05/12/2017).

Bosnia and Herzegovina, according to which the wearing of the skullcap does not represent a strong religious duty, but it has such strong traditional roots that many people consider as a religious duty.¹⁰⁴ Without discussing the merits of this issue, the Court went on to examine the extent to which the restrictions imposed on the applicant's "freedom to manifest a religion" complied with the principles set out in Article 9 (2) of the Convention. In that way, the Court indirectly recognized that an act, which is not closely related to a particular religious doctrine, could still be regarded as its "manifestation" if the actor sincerely believes that the act constitutes a direct religious obligation. Moreover, the Court explicitly declared that there was no reason to suspect that the applicant's conduct was inspired by his sincere religious beliefs.

It should be emphasized that in discussing this case, the Court again referred to the reasonings developed in the *Arrowsmith* and *Eweida* Cases,¹⁰⁵ but did not restrict itself to the severe assessment test used in the case of *Arrowsmith* or its modified version used in the case of *Eweida*. This fact is important for a clear demonstration of coherence development of the "Manifestation Test."

Moreover, it is generally accepted that a person may follow a practice of religion that differs from the general practice of the religious community to which he or she belongs, and this right is protected by the freedom of religion and belief.¹⁰⁶ Accordingly, national authorities and the Court are required to observe this fundamental principle and, in all relevant cases, exercise extreme caution in examining the connection between personal and collective practices of religion. In no case, however, they should not rely solely on the generally recognized (by a community) forms of a particular "practice" to classify personal conduct or

¹⁰⁴ *Ibid.* § 30.

¹⁰⁵ *Ibid.* §§ 41, 125.

¹⁰⁶ Guidelines for Review of Legislation Pertaining to Religion or Belief. OSCE. ODIHR. (2004). II.B.2.

action as a "manifestation" of religion. For in such a case, the freedom of religion and belief will lose its personal nature and original essence.

4. Osmanoglu and Kocabaş v. Switzerland¹⁰⁷

The fundamental innovation regarding the Manifestation Test the Court was made in 2017. In this case, the applicants were Muslim parents who wanted, on religious grounds, to have their daughters exempted from compulsory mixed swimming lessons at their primary school. Although the Koran laid down the precept that the female body has to be covered only from puberty, the applicants stated that their faith instructed them to prepare their daughters for the precepts that would be applied to them from puberty onwards. Their request for an exemption was refused. Under the applicable Cantonal law, pupils could not be exempted until they reached puberty. The applicants continued to refuse to send their daughters to swimming lessons. The authorities accordingly imposed minor-offense fines on them. The applicants alleged before the Court that the obligation to send their minor daughters to mixed swimming lessons was contrary to their religious convictions. The applicants submitted a complaint before the Court under Article 9 of the Convention and Article 2 of Protocol No. 1 to the Convention. As Switzerland has not ratified the Protocol, which is in principle the *lex specialis* in relation to Article 9 of the Convention, the Court considered the case under Article 9 of the Convention.

The Court held that the case concerned a situation where the applicants' right to manifest their religion was in issue. Therefore, they were entitled to rely on this aspect of Article 9 of the Convention. The Court considered, furthermore, that the applicants indeed suffered interference with the exercise of their right to freedom of religion as protected by that provision.¹⁰⁸ However, the interference

¹⁰⁷OSMANOĞLU AND KOCABAŞ v. SWITZERLAND (29086/12. 10/01/2017).

¹⁰⁸ *Ibid.* §§ 41, 42.

had pursued a legitimate aim, namely to protect international students from any form of social exclusion.

It is noteworthy that the Court in this case referred only to the modified approach set forth in the Eweida case, not to the severe Arrowsmith Test, which gives hope that the latter may finally be ignored. Moreover, unlike the Case of Hamidović, where the Court relied on a collective assessment, in the Osmanoğlu case, neither there was no similar argument in the case file¹⁰⁹, nor did the Court develop reasoning in this regard.

As for the modified Eweida approach in particular, a "close and direct nexus between the act and the underlying belief," it is not necessary to interpret this nexus only in the contextual sense, but, moreover, in the sense of the act of faith. This implies that a "close and direct nexus" can be expressed in the firm faith of the person that his or her belief precisely compels such an act. One argument is that even when there is a close and direct contextual connection between an act and a belief, that act still requires a "firm faith" to be fulfilled. Thus, as faith is of primary importance, it must be a decisive factor even when there is no close and direct contextual connection between the belief and the act, or it is not a direct religious obligation.

Summary of the Manifestation Test development

All of the above mentioned indicates that the practice of the Organs of the Convention concerning the development of the Manifestation Test is conventionally divided into four stages:

¹⁰⁹ On the contrary, the Case states that only a small number of Muslim parents living in Switzerland request such an exemption. *Ibid.* § 97.

1. *The Arrowsmith's Severe test* - to consider an act as a manifestation, it must constitute a direct obligation of the religion or belief in question. Furthermore, the burden of proof of the conformity of the act and conviction is on the applicant;

2. *The Eweida's Modification* - to consider an act as a manifestation, it must have a close and direct connection to the religion or belief in question. However, a person is not obliged to establish that he or she acted in fulfillment of a duty mandated by the religion in question;

3. *The Hamidović's Change* - to consider an act as a manifestation, it can be not a direct religious duty, but could still be regarded as manifestation if it has such strong traditional roots that it is collectively considered as such.

4. *The Osmanoglu's Innovation* - to consider an act as a manifestation, it is not necessary to be directly derived from that religion or belief, but the actor's sincere faith that she or he acts in accordance with his or her own religion or belief is sufficient.

This experience of the Organs of the Convention indicates that the Manifestation Test has an interesting and necessary evolution, which, in turn, gives us hope that it will eventually progress into a right of personal self-determination.

Conclusion

Although the Manifestation Test had a long and complicated evolution, the recent approach demonstrated by the Court in the *Osmanoğlu* case is obviously hopeful. According to this approach, an act may be regarded as the manifestation of religion or belief even if that does not constitute a direct duty of the religion or belief in question as long as it is understood as such by its author's sincere belief. Indeed, the right to manifest a religion or belief, as well as the right to have them, is, in its essence, a matter of highly personal self-determination. Therefore, it is logical that the classification of any act as the manifestation of a particular religion or belief must be based principally on its author's sincere faith that her or his religion or belief requires precisely such an act and not even the assessments of relevant religious community or institute. Through this innovation, however, the Court has clearly emphasized the personal nature of the faith. Accordingly, the individual freedom of the manifestation of religion or belief is released from the obligation of precise coherence with specific doctrinal dogmas and rules of conduct and, thus, from the collective power of religious communities or institutions.

It is also important to note that this approach may deserve some critique. For example, such an argument may be the threat to "abuse" the freedom of religion and belief as a universal human right, and an attempt to protect and justify under it acts that would not otherwise be protected and justified. For instance, if an act is classified as a manifestation of religion or belief, it will enjoy higher protection than the same act under the general right to Freedom of Expression. This higher guarantee implies that Article 9 (Freedom of thought, conscience, and religion) and Article 10 (Freedom of expression) of the Convention cover different legitimate aims for restrictions. For example, unlike the Freedom of Religion and Belief, the Freedom of Expression may be subject to such restrictions as "interests of national security." The same can be said, in principle, about the right to Freedom of Assembly and Association (Art. 11 of the Convention).

Article 18 of the Convention (Limitation on use of restrictions on rights) says: "The restrictions permitted under this Convention to the said rights and freedoms shall not be applied for any purpose other than those for which they have been prescribed." Taking into account this fact, we can theoretically assume that if the Court gives up its power of assessment in classifying a particular act as a manifestation of the religion or belief in question and leave the issue entirely in the field of personal self-determination, there may arise some risks. For example, the call against the national security one may determine as a manifestation of personal belief and consequently demand it to be justified and protected by Article 9. In such circumstances, this act cannot be restricted in pursuit of the "the interests of national security" under Article 10.

First, this argument is fascinating and important, including in terms of independent research, and therefore more complete and extensive discussion goes beyond the scope of this article. However, its significant nullification is possible under Article 17 of the Convention - Prohibition of abuse of rights. Thus, to avoid such a risk, in the establishment of the legitimacy of the particular religious practice, the task of the Court should not be the essential examination of the nexus between the act and the religion in question. The Court should resolve this issue with instruments such as the "prohibition of abuse of rights" and the "incompatibility *ratione materiae* with the Article 9 of the Convention of an application".¹¹⁰

¹¹⁰ For example, the Court found the inadmissibility on grounds of incompatibility *ratione materiae* with the Convention of an application lodged by a "global Islamic political party" complaining of the prohibition by the relevant German authorities of its activities in Germany. The Court considered that since it called for the violent destruction of the State of Israel and for the banishment and killing of its inhabitants, this party could not rely on the protection of Articles 9, 10 and 11, in pursuance of Article 17 of the Convention (prohibition of abuse of rights). HIZB UT-TAHRIR AND OTHERS v. GERMANY (31098/08. 12/06/2012).

Lastly, it is still difficult to say whether the Court will finally give up its power to classify an act as a manifestation of religion or belief and ultimately leave this issue entirely in the field of personal self-determination. The Court may see some (at least as mentioned above) of the risks involved in practicing this approach. Violating or damaging the personal dimension of the freedom of religion or belief to avoid such risks is entirely unjustified.

Online Dispute Resolution in Georgia: The Benefits and Challenges

Disputes are an inevitable part of our lives. Considering the time and expense, the courts are not the best solution for either party, and many acknowledge the effectiveness of Alternative Dispute Resolution (ADR), which eliminates the common obstacles of litigation. However, if the parties are located in different countries, they still need to travel lengthy distances to resolve the dispute. Developments in communication technology has created more convenient and creative possibilities for ADR, specifically, transforming ADR into Online Dispute Resolution (ODR), which allows parties to reach a solution through the internet and without any limitations. While developed countries are already well aware of the numerous possibilities ODR provides, it remains a novelty in developing countries and its growth there necessitates that several factors to be implemented.

Keywords: *Online Dispute Resolution (ODR); Alternative Dispute Resolution (ADR); Information Communication Technology (ICT); COVID-19; electronic commerce (e-commerce); Developing Countries; Georgia*

Online Dispute Resolution is also known as “Electronic-ADR” (e-ADR), “Internet Dispute Resolution” (IDR), “Technology Mediated Dispute Resolution” (TMDR), or “Online Alternative Dispute Resolution” (OADR).¹¹¹ There is no common agreement to the definition of ODR, but in simple terms it applies to a dispute resolution process organized online and a process where online software conducts the main part of a dispute resolution process.¹¹²

This article demonstrates ODR as a feasible way of resolving disputes for Georgia and, therefore, intends to find out what challenges could appear in case of its implementation. ODR suggests numerous advantages. First, it is considered to be less costly and time consuming compared to the traditional practice of in-person dispute settlements.¹¹³ Particularly for small disputes, it is too expensive to travel in each country for resolving disagreements. Characteristics of online dispute resolution, such as e-mail, chat conference rooms, instant messaging, or videoconferencing, significantly mitigates the costs related to travel.¹¹⁴ Additionally, it is not required to rent a neutral facility to administer the process, and appropriate documents or materials are also readily accessible and do not have to be transported lengthy distances.¹¹⁵ Therefore, conducting dispute resolution online reduces travel costs for all parties and mitigates the importance of and expenses related to physical premises.¹¹⁶ Traditional Dispute resolution mechanisms, such as courts, in many cases are

¹¹¹ Zissis L (2015) Disputes in the digital era: The evolution of dispute resolution and the model ODR system, (Toulouse) 151

¹¹² Blake S, Browne J, Sime S (2014) A Practical Approach to Alternative Dispute Resolution, (Oxford University Press, Third edition) 69

¹¹³ Kaufmann-Kohler G & Schultz T (2004) Online Dispute Resolution: Challenges for Contemporary Justice (International Arbitration Law Library, KLI) 55

¹¹⁴ Zissis, 2015 (n 1) 223

¹¹⁵ Gibbons L; Kennedy R; Gibbs J (2002) Cyber-Mediation: Computer-Mediated Communications Medium Massaging the Message, (New Mexico Law Review, NML Rev) 27

¹¹⁶ Ebner N & Getz C (2012) ODR: The Next Green Giant, Conflict Resolution Quarterly

expensive and time consuming, which leads to unsatisfied disputants. ODR reduces these tensions.

ODR is flexible and user-friendly, allowing for numerous communication methods.¹¹⁷ ODR is accessible irrespective of the time and location of the parties, allowing participation in the process even if disputants are living in absolutely different countries or different time zones.¹¹⁸ ODR also increases accessibility of dispute resolution through reducing barriers of financial background, disability, geographical distance, shyness in physical context, and other potential obstacles to accessing justice. In addition, some believe that a traditional dispute resolution gives priority to those individuals who are “articulating, well-educated, or members of a dominant ethnic, racial or gender group.”¹¹⁹ Disputes are an inevitable part of our lives, and individuals should have an opportunity to find an amicable, fast, and effective solution through the use of technology and dispute resolution proceedings have to adapt and be innovative. Since disputants wish to avoid complicated procedures, ODR appears to be the relevant method of dispute settlement.

Georgia has adopted a new law on mediation¹²⁰ on January 1st, 2020 which is obviously a successful step forward. As in other countries, courts in Georgia are overloaded and are not always able to handle disputes in a timely manner. According to the statistical data for the year of 2018, the number of civil cases heard at the Common Courts of Georgia is estimated at 125,791 and, in total,

¹¹⁷ Cortés P (2011) *Online Dispute Resolution for Consumers in the European Union*, (1st edition) 150

¹¹⁸ Freitas P & Palermo P (2016) *Restorative Justice and Technology, Interdisciplinary Perspectives on Contemporary Conflict Resolution*, (IGI Global) 85

¹¹⁹ Tyler M & McPherson M (2006) *Online Dispute Resolution and Family Disputes* (U of Melbourne Legal Research Paper) 11

https://papers.ssrn.com/sol3/papers.cfm?abstract_id=1032743

¹²⁰ Law of Georgia on Mediation

<https://matsne.gov.ge/en/document/download/4646868/0/en/pdf>

only 74,562 of them were completed.¹²¹ Therefore, the need for an effective and fast dispute resolution mechanism is obvious.

The global COVID-19 pandemic has changed most of our lives, and many communal activities, from education to occupations, went online. COVID-19 draws a picture of virtual reality. “The spread of COVID-19 has changed our daily lives dramatically. The world has not encountered a pandemic of this nature since 1918, where people were forced to stay in isolation.”¹²² Because of social isolation caused by Coronavirus, the demand for ODR has risen sharply. Living through the COVID-19 era has obviously provided adequate opportunity to Go to The Balcony, a “metaphor for a mental and emotional place of perspective, calm and self-control”, and truly understand and manage the emotions that grip at this time.¹²³

To mitigate the spread of COVID-19, the government of Georgia issued ordinance №181 on March 23, which includes a number of restrictive measures, such as transportation services, educational process, demonstrations, and cultural and economic activities.¹²⁴ The ordinance does not itself restrict remote forms of communication. As the situation shows the need for online services and alternative dispute resolution, Mediation and Arbitration becomes available

¹²¹ Supreme Court of Georgia, The Judiciary in Georgia – Statistical Data for the Year 2018, <http://www.supremecourt.ge/eng/statistical2018/> (Accessed on July 3, 2020)

¹²² Ali N, (2020) The Demand for Online Mediation Spikes during COVID-19 Coronavirus Outbreak <https://www.mediate.com/articles/ali-online-mediation.cfm> (Accessed on July 3, 2020)

¹²³ Ollapally T, (2020) Making Sence of COVID through the Lens of Mediation <https://www.mediate.com/articles/ollapally-COVID-Mediation.cfm> (Accessed on July 3, 2020)

¹²⁴ Government of Georgia Ordinance No 181 23 March 2020, On the Approval of Measures to be Implemented in connection with the Prevention of the Spread of the Novel Coronavirus (COVID-19) in Georgia, <https://matsne.gov.ge/en/document/view/4830610?publication=14> (Accessed on April 4, 2020)

remotely (Annex 2). The government uses remote mediation and arbitration as it is not specified in any legislative acts of Georgia. “Similarly, the Ministry of Justice of China issued a guideline on March 3. The guideline emphasizes the importance of online dispute resolution, or ODR, for achieving its goal of getting the economy back on track while still maintaining control over the spread of COVID-19.”¹²⁵ The unforeseeable situation revealed the potential of online dispute resolution in several countries.

Georgia can benefit from the use of ODR in numerous ways. First, the area of commercial activities will increase. More and more businesses or organizations would engage in the process of ODR. As well, consumers would gain trust for the effective redress mechanism that ODR provides. Developing ODR in Georgia would also increase the chances of attracting more neutral, third-party mediators. ODR obviously would also encourage the economic development because of the lower expenses compared to the traditional dispute resolution methods. ODR would also motivate developing countries to engage in cross-border international transactions and implement best practices of online dispute resolution. However, in order to fully develop the potential of ODR in Georgia, the de facto use is not enough. We need to be sure that as the pandemic fades virtual ADR continues to expand rather than to disappear. There are several challenges that should be taken into consideration while implementing ODR.

Challenges

A. Infrastructure and Accessibility

Developing countries generally cannot necessarily provide the broadband infrastructure needed for widespread internet access, and this obviously limits

¹²⁵ Chow V, (2020) China Pushes for Increase in Online Dispute Resolution as it Reboots Economy, <http://odr.info/china-pushes-for-increase-in-online-dispute-resolution-as-it-reboots-economy/> (Accessed on 24 March 2020)

the level of e-commerce and, therefore, the need for ODR in online transactions.¹²⁶ Therefore, one apparent challenge for the implementation of ODR could be the problem of access to technology. Technical issues may establish barriers such as the degree of sophistication of the general mass of information technology (IT) equipment available in business and in the community.¹²⁷ “To improve the population's level of computer and cyber literacy, a proactive and effective education policy in the field is needed. Governments have a crucial role to play in the design and implementation of programs to provide nationwide access to computers and corresponding trainings.”¹²⁸

Moreover, to run the ODR process in a fair manner, both parties – as well as the third-party neutrals should have an adequate level of digital literacy – or at least qualified assistance.

For developing countries, the first step to a robust Internet ecosystem should be quality infrastructure. Simple infrastructure, such as reliable electricity supply and roads to enable postal delivery, is necessary, as is quality fixed or mobile Internet infrastructure.¹²⁹ It follows that, within rich nations, the use of an Internet environment in conflict-resolution is becoming completely extensive. Individuals who believed in the necessity for a new field of dispute resolution also acknowledged the possible challenges related to Internet and its disputes could be addressed with online resources.¹³⁰ “Disputants in developing

¹²⁶ Parlade C (2003) Challenges to ODR implementation in a Developing Country, Proceedings of the UNECE Forum on ODR

¹²⁷ Ross G (2003) Challenges and Opportunities in implementing ODR
<https://www.mediate.com/Integrating/docs/ross.pdf>

¹²⁸ Albornoz M & Martín N (2012) Feasibility Analysis of Online Dispute Resolution in Developing Countries (IALR) 54

https://papers.ssrn.com/sol3/papers.cfm?abstract_id=2184447

¹²⁹ Ibid

¹³⁰ Raines S & Tyler M (2006) From E-bay to Eternity: Advances in Online Dispute Resolution, (U of Melbourne Legal Studies Research Paper)

countries do not have access to the land-lines and the steady electricity necessary for ODR which depends primarily on personal computers (PCs). Instead, innovations in OADR are occurring with non-PC technologies, such as cell phones, radios, Blackberries, and other wireless technologies.”¹³¹

In Georgia it is considered that the access to Internet content is largely unrestricted. “The legal constitutional framework, developed after the 2003 Rose Revolution, established a series of provisions that should, in theory, curtail any attempts by the state to censor the Internet.”¹³² In addition, legal instruments are considered not to be sufficient enough to prevent limited filtering. The fixed-line telecommunications network in Georgia remains outdated, and there is a need for a profitable investment. The network has a significantly limited coverage outside Tbilisi, Georgia’s capital, but even inside the capital the quality of telecommunications varies considerably. In urban areas there are around 20 lines per 100 inhabitants while in rural areas there are only around four lines per 1,000 inhabitants.¹³³ The Ministry of Economic Development encourages communications service sector by simplifying the procedures when consumers bring disputes against operators and forbidding suspensions of service in the event of a dispute. Furthermore, consumer’s rights to confidentiality are protected. The regulation introduces a simple system of general authorization instead of an individual license regime, which prevents abuse of powers and recognizes principles of technological neutrality with the specific sanctions regime in case of violations.¹³⁴

According to the recent statistics in Georgia, E-commerce use in the population is estimated to have been 20.8 percent for 2019. The lowest indicator refers to people of 60 years or older (as in the previous years of 2016-2018). For January

¹³¹ Ibid, 5

¹³² Delbert R, Palfrey J, Rohozinski R, Zittrain J (2010) Access Controlled: The shaping of Power, Rights, and Rule in Cyberspace (Massachusetts Institute of Technology) 173

¹³³ Ibid

¹³⁴ The Law of Georgia on Electronic Communications

1, 2019 access and use of the internet in enterprises is estimated to have been 93 percent, a decrease compared to the previous years of 2016-2018. Also, there is a high indicator of non-existence of the enterprise's websites or webpage by January 1, 2019 (81.6 percentages) while the previous years showed a better image. Regarding the share of households with computer access, there was 62.0 percent for July, 2019 in Georgia.¹³⁵As the statistics show, internet infrastructure in Georgia varies significantly by years. Overall, it creates a challenging image for the development of a digital environment. There is still much to be done to eradicate connection problems, especially in the regions where many people do not have a personal computer and access to the internet.

B. Creating Awareness and Trust

Lack of awareness can be one of the main obstacles for ODR in Georgia. Compared to Georgia, other countries began to move towards alternative dispute resolution decades ago. The effectiveness of ODR, in addition to other factors, should be based on public acceptability. It is important to establish public awareness within developing nations. "There is a need to set up programs to inform the judiciary in all countries of the available systems for ODR and the benefits to gain court encouragement."¹³⁶ "In order to enhance public awareness of ODR, there should be more channels to provide the public with information on ODR services and access to more diversified ODR services."¹³⁷

Governments, businesses, e-consumers, and ODR providers should be responsible for establishing confidence, because building trust for e-commerce is considered to be a major undertaking.¹³⁸ "The online procedure must fulfill

¹³⁵ National Statistics Office of Georgia (Geostat) <https://www.geostat.ge/en> (Accessed on July 3, 2020)

¹³⁶ Ross, 2003, (n 17) 4

¹³⁷ Zheng, J. (2016). The role of odr in resolving electronic commerce disputes in china. *International Journal of Online Dispute Resolution*, 3(1), 41-68

¹³⁸ Albornoz & Martín, 2012, (n 18) 53

security requirements concerning privacy, integrity and authenticity.”¹³⁹ Parties need to be sure that the confidentiality issues are protected accordingly. The best way to guarantee confidentiality is through encryption. “Encryption technology is likely to protect the confidentiality of the process itself as well as the authenticity of any electronic communications, in order to prevent unauthorized access to information.”¹⁴⁰ Therefore, the lack of trust will be avoided if end users are aware of the security and protection devices. Also, a possible way to increase the parties’ trust during the process can be achieved by using anti-virus and anti-malware programs.¹⁴¹

Parties would then feel comfortable in electronic environments and express their willingness to subject e-disputes to ODR proceedings. Therefore, ODR system should provide security of exchanges, such as digital signatures, encryptions, and firewalls for a secure environment.¹⁴² People do not usually share private information through the internet, such as using credit cards for online purchases, because of possible misuse and lack of availability in resolving potential disputes.¹⁴³

Awareness and trust are considered to be essential elements for the “widespread acceptance of online dispute resolution as a fully- fledged alternative to ADR and litigation.”¹⁴⁴ Communication based on trust is essential to the success of any ODR. If individuals trust each another, cooperation is also

¹³⁹ Suquet-Capdevila, J. (2012). Exploring online consumer mediation in catalonia: Principles and technological uses. *International Journal of Law and Information Technology*, 20(2), 124-146.

¹⁴⁰ Lavi, D. (2016). Three is not crowd: Online mediation-arbitration in business to consumer internet disputes. *University of Pennsylvania Journal of International Law*, 37(3), 871-940.

¹⁴¹ *Ibid*, 935

¹⁴² Fangfei Wang F (2009) *Online Dispute Resolution -Technology, management and legal practice from an international perspective*, (Chandos Publishing: Oxford England)

¹⁴³ *Ibid*

¹⁴⁴ Katsh E & Rifkin J (2001) *Online Dispute Resolution: Conflict Resolution in Cyberspace*, 1st edition

promoted, which then transfers into a problem-solving and effective bargaining. As a result, conflicts can be resolved effectively.¹⁴⁵ Establishing trust in online environment can be achieved by trustmarks, which are created by independent organizations and displayed on the website of online businesses.¹⁴⁶ “The creation of a trustmark system specifically for ODR providers may increase the willingness of businesses and consumers to engage in online dispute resolution.”¹⁴⁷ Transparency and trust can also successfully be achieved by publications of the decision. However, this should not be in opposition to confidentiality. “Keeping the names of the parties as confidential or using impersonal statistical data, sample cases, selective publication of decisions” indicates the balance between publication and confidentiality.¹⁴⁸

C. Availability of Neutrals

ODR is the process of online dispute resolution, where a neutral third-party’s involvement is essential. “For that aspect of ODR that involves neutrals, there is clearly a challenge to ensure a ready supply of neutrals sufficient to meet the need generated by the system.”¹⁴⁹ ODR training is essential to ensure that best use is made of the facilities. Experience in due course will generate needed tactics, skills, and approaches specific to the online process.¹⁵⁰ Neutrals should be trained in different techniques “to be employed when not involved in ‘whites of the eye’ techniques inherent in face to face mediation.”¹⁵¹ The standard

¹⁴⁵ Nauss Exon S, (2011) 'Maximizing Technology to Establish Trust in an Online, Non-Visual Mediation Setting' 33 U La Verne L Rev 27

¹⁴⁶ Zwass V, (1996) Electronic Commerce: Structures and Issues, 1 International Journal of Software Quality, 3

¹⁴⁶ Nenstiel A, (2006) Online Dispute Resolution: A Canada-United States Initiative (32) 316

¹⁴⁷ Ibid

¹⁴⁸ Zissis, 2015 (n 1) 422

¹⁴⁹ Ross, 2003, (n 17) 5

¹⁵⁰ Ibid

¹⁵¹ Ibid

training of neutrals would not be sufficient as online dispute resolution differs from traditional dispute resolution. Rather a specialized training focused on those new, ODR techniques would be required.¹⁵² Currently, the Mediators Association of Georgia implemented mediator's certification program which aims to increase the awareness of ADR and attract future mediators. The certification program does not itself cover the ODR training facilities; however, it may be successfully implemented in the future.

D. Expenses

In order to conduct ODR, there is a need for an ODR platform. It may be necessary to bring specialized know-how and professionals from developed countries to create new ODR platforms and software.¹⁵³ In addition, ODR platform will also require setting specific policies by the government. Generally, in order to be effective, ODR providers need to cover "the costs of hardware and software infrastructure, the secretariat, costs related to case administration and the fees and expenses of mediators and arbitrators. In order to cover these costs the ODR provider can search for funding from either both the parties by charging bilateral fees, or from one party by charging unilateral fees or by external sources."¹⁵⁴

The technological structure of ODR providers depends on the method of the dispute resolution and on its nature. However, there are basic requirements common to all ODR providers. Specifically, it should be easy to use and accessible without any obstacles, taking advantage all possible ICT tools and providing specific communication capabilities when required. Specific communication capabilities include basic tools of asynchronous communication, such as e-mail for low-tech users and more advanced tools for those with greater technical

¹⁵² Ibid

¹⁵³ Ibid

¹⁵⁴ Zissis, 2015 (n 1) 398

experience, such as videoconferencing, teleconferencing, and discussion environments.¹⁵⁵

Whether as services for profit or not, ODR may be established at little or no cost to the government, based how the service may be integrated into the judicial dispute resolution process. Compared to the creation of new courts, for example, establishment of an ODR network does not necessitate huge financial expenses, such as obtaining large physical offices. Practical considerations, therefore, obviously weigh in favor of ODR implementation even in a developing country context.¹⁵⁶

E. COVID-19 Approach

"I find it immensely ironic that the Coronavirus crisis will do more for virtual courts than decades of work by the National Center for State Courts (NCSC). I am glad to see it come, even if this is not the way I would wish it to happen."

Dr. Tom Clarke, National Center for State Courts

COVID-19 studies have shown that online negotiations are more likely to end in impasse than are face-to-face negotiations.¹⁵⁷ There are three key challenges to making virtual negotiations more difficult: trust, communication conundrum, and cross-cultural gap. "Reliant on small talk, body language and shared meals and laughs, trust thrives in physical presence."¹⁵⁸ In order to eliminate unfavorable consequences, mediators have to maximize trust in the online process by choosing the right medium (whether phone, videoconferencing, or e-

¹⁵⁵ Ibid

¹⁵⁶ Parlade, 2003 (n 16) 9

¹⁵⁷ Winkler C, (2020) Bloomberg Law, INSIGHT: Improving Virtual Negotiation Skills in Cross-Cultural Interactions

https://news.bloomberglaw.com/corporate-governance/insight-improving-virtual-negotiation-skills-in-cross-cultural-interactions?utm_source=sendy&utm_medium=email&utm_campaign=IDPA_Registration_ends (Accessed on June 16, 2020)

¹⁵⁸ Ibid

mail). Mediators should match a pitch, speed, and tone to create rapport in an online environment. Cross-cultural interactions make online relationships even difficult because of the social norms or lack of contextual cues, and mediators should acquire and bring with them into their activities a high level of cross-cultural competency as “there is no typical European, Asian or American”¹⁵⁹.

¹⁵⁹ Ibid

References

Albornoz M & Martín N (2012) Feasibility Analysis of Online Dispute Resolution in Developing Countries (IALR)

Ali N, (2020) The Demand for Online Mediation Spikes during COVID-19 Coronavirus Outbreak

Blake S, Browne J, Sime S (2014) A Practical Approach to Alternative Dispute Resolution, (Oxford University Press, Third edition)

Chow V, (2020) China Pushes for Increase in Online Dispute Resolution as it Reboots Economy

Cortés P (2011) Online Dispute Resolution for Consumers in the European Union, (1st edition)

Delbert R, Palfrey J, Rohozinski R, Zittrain J (2010) Access Controlled: The shaping of Power, Rights, and Rule in Cyberspace (Massachusetts Institute of Technology)

Ebner N & Getz C (2012) ODR: The Next Green Giant, Conflict Resolution Quarterly

Fangfei Wang F (2009) Online Dispute Resolution -Technology, management and legal practice from an international perspective, (Chandos Publishing: Oxford England)

Freitas P & Palermo P (2016) Restorative Justice and Technology, Interdisciplinary Perspectives on Contemporary Conflict Resolution, (IGI Global)

Gibbons L; Kennedy R; Gibbs J (2002) Cyber-Mediation: Computer-Mediated Communications Medium Massaging the Message, (New Mexico Law Review, NML Rev)

Katsh E & Rifkin J (2001) Online Dispute Resolution: Conflict Resolution in Cyberspace, 1st edition

Kaufmann-Kohler G & Schultz T (2004) Online Dispute Resolution: Challenges for Contemporary Justice (International Arbitration Law Library, KLI)

Lavi, D. (2016). Three is not crowd: Online mediation-arbitration in business to consumer internet disputes. *University of Pennsylvania Journal of International Law*

Nauss Exon S, (2011) 'Maximizing Technology to Establish Trust in an Online, Non-Visual Mediation Setting' *33 U La Verne L Rev* 27

Nenstiel A, (2006) *Online Dispute Resolution: A Canada-United States Initiative*

Ollapally T, (2020) *Making Sense of COVID through the Lens of Mediation*

Parlade C (2003) *Challenges to ODR implementation in a Developing Country, Proceedings of the UNECE Forum on ODR*

Raines S & Tyler M (2006) *From E-bay to Eternity: Advances in Online Dispute Resolution, (U of Melbourne Legal Studies Research Paper)*

Ross G (2003) *Challenges and Opportunities in implementing ODR*

Suquet-Capdevila, J. (2012), *Exploring online consumer mediation in Catalonia: Principles and technological uses. International Journal of Law and Information Technology*

Tyler M & McPherson M (2006) *Online Dispute Resolution and Family Disputes, U of Melbourne Legal Research Paper*

Winkler C, (2020) *Bloomberg Law, INSIGHT: Improving Virtual Negotiation Skills in Cross-Cultural Interactions*

Zheng, J. (2016). *The role of odr in resolving electronic commerce disputes in china. International Journal of Online Dispute Resolution*

Zissis L (2015) *Disputes in the digital era: The evolution of dispute resolution and the model ODR system, (Toulouse)*

Zwass V, (1996) *Electronic Commerce: Structures and Issues, 1 International Journal of Software Quality*

Elene Golovachova¹,
Tinatin Mikadze²,
Manana Kalandadze³
Tbilisi State University

The Association Between Oral Habits, Mouth Breathing, and Malocclusion in Georgian Preschoolers

The perfect primary dentition is the predictor of future normal permanent occlusion. One of the main roles of primary dentition is to determine permanent occlusion, which should be supported by normal functional and muscular development. The aim of this study was to evaluate the prevalence of malocclusion and correlated risk factors among Georgian preschoolers and to verify if there is an association between oral habits, mouth breathing, and maxillofacial disorders.

Multi-stage cluster sampling with preliminary stratification was applied to obtain a representative sample of preschoolers. In each stratum, kindergartens were selected using the PPS (Probability Proportional to Size) method. Questionnaires were given to parents to find out general health problems, functional changes, and the presence of non-nutritive sucking habits.

The data showed that 49.8% of evaluated children had malocclusion. Functional disorders were revealed in almost half of the preschoolers examined (46.9%). Based on our study, 28.2% of examined children had breathing problems, followed by speech problems at 11%, incorrect swallowing patterns (6.9%), and chewing dysfunction (0.8%). In mouth breathers, there was a higher incidence of Class II than in children with normal breathing patterns (RR=2.93). The frequency of thumb sucking habit was 11.5%, with a high incidence and relative risk of an anterior open bite (25.2%; RR=4.90). Children with a prolonged pacifier sucking habit had had a high incidence of Class II canine and molar relationship.

The present study shows that bad oral habits and mouth breathing can be one of the main risk factors of developing malocclusion. Early diagnostics, preventive intervention, and treatment can avoid the development of skeletal discrepancies, have an impact on facial growth and psychological well-being.

Keywords: oral habits, mouth breathing, malocclusion

¹DDM, PhD student, Orthodontist; ²Professor, M.D, PhD, Head of orthodontic department at TSMU;

³M.D, PhD, Associate Professor at the Department of Dental and Face and Jaw Surgery at the TSU Faculty of Medicine.

Malocclusion is a multifactorial developmental condition, so etiopathogenesis can be genetic as well as environmental. In most instances, malocclusion and dentofacial deformity can be caused by some distortions of normal development. Generally, these distortions arise as a result of various interacting factors that influence growth and development. Therefore determining the exact factor is impossible.¹

Non-nutritive sucking habits and mouth breathing are some of the most significant risk factors for malocclusion since they can interfere with normal craniofacial development, which is stimulated by functional and muscular activities of the oral cavity.² Infants have an instinctive need for sucking that can be fulfilled by nutritive, including breast or bottle-feeding or non-nutritive sucking (NNS) habits. During primary dentition, almost all children engage NNS habits, such as digit and pacifier sucking, that generally do not have long-term effects. However, it is possible to deform alveolar bone and cause sagittal, vertical, or transversal discrepancies with prolonged and intensive habits. The severity of deformation depends on the frequency and duration of sucking movements.¹

There are many studies regarding the importance of breastfeeding for the normal development of the masticatory system. Breastfeeding involves intense muscular activity, which favors normal lip and tongue position, while bottle-fed children apply more passive movements. An extended period of breastfeeding is associated with better occlusal conditions. However, several studies have reported prolonged and unrestricted breastfeeding as a potential risk factor for occlusal abnormalities and primary tooth caries (ECC).^{3,4}

There are many studies concerning the relationship between NNS and malocclusion. Children with oral habits (such as pacifier, digit-sucking habits, and mouth breathing) are significantly more likely to develop anterior open bite, increased overjet, Class II canine relationship, and posterior crossbite, as compared to children without a habit history.^{5,6,7}

Mouth breathing can affect the normal development of the maxillofacial region, causing disturbances in skeletal and dental growth, manifested in narrow maxilla, high palatal vault, incorrect tongue position, long face, Class II or Class III profile, shortened upper lip, everted lower lip and forward head posture.⁸ Allergic rhinitis, adenotonsillar hypertrophy, and septum deviation are the main reasons for the airway obstruction that forces a child to breathe through the mouth.⁹ However, there can be different reasons, such as functional mouth breathing resulting from prolonged oral habits and muscular alterations.¹⁰

Methodology

The data for this cross-sectional study was obtained from Tbilisi kindergartens. Multi-stage cluster sampling with preliminary stratification was applied to obtain a representative sample of preschoolers. In each stratum, kindergartens were selected using the PPS (Probability Proportional to Size) method.

Three hundred and ninety-six children aged 3 to 5 were evaluated in kindergartens drawn from ten districts of Tbilisi. Children were examined on-site. Occlusion was checked in maximum intercuspation. When necessary, their mandibles were reoriented into centric relation. Data

inclusion criteria included the existence of fully erupted primary dentition, no partially or fully erupted permanent teeth, and no history of any orthodontic intervention. Data exclusion criteria were the presence of any permanent teeth, loss of any primary teeth, extensive dental caries that could affect the mesiodistal or occlusogingival dimension of a tooth and, therefore, influence the occlusal characteristics, tooth agenesis, congenital disorders (such as cleft lip/palate) or severe illness and children unable to cooperate with the researcher. The survey was conducted from March 2019 to June 2019. Written permission from the kindergarten governing agency and written informed consent from parents or legitimate guardians of the participating children were obtained in each case. This study was approved by the Tbilisi State Medical University Biomedical Research Ethics Committee (re: 2015-0012 N1-2018/66. 17.04.2018).

The study was held in the classroom provided by school authorities. Children were examined by certified professionals, who did a direct visual inspection of occlusion and all its aspects under natural light in the presence of their parents/guardians, using a pair of disposable gloves and a mirror. The same professional interviewed parents using a special questionnaire. Based on this questionnaire, a retrospective investigation was made concerning the age and sex of the child, feeding pattern (breast and/or bottle), the child's non-nutritive sucking habits (digit or pacifier), and duration of these habits. The health status of the mother during pregnancy was also taken into consideration.

Their dental status was evaluated according to the Oral Health Assessment Form for Children (WHO 2013).¹¹ Occlusal relationships were evaluated using Foster and Hamilton criteria.¹²

The obtained data was processed and analyzed using the SPSS v21.00 (Statistical Package for Social Sciences). The significance level is 0.05 for all statistical tests. Independent - samples T test was used to compare the variables.

Results

An investigation of 396 children aged 3 to 5 years, with an equal number of male and female subjects, revealed that the prevalence of malocclusion among Tbilisi preschoolers was 49.8%. As we see from Figure 1, the prevalence of malocclusions was Class II 21.2%, deep overbite 10.7%, crossbite 7.0%, anterior open bite 6.9%, Class III 1.6%.

Figure 1. Prevalence of occlusal anomalies among Tbilisi preschoolers

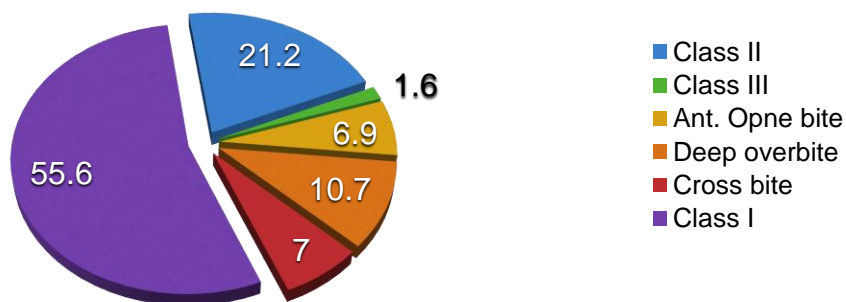

Several risk factors were evaluated during the study, including genetical predisposition, the health status of the mother, birth trauma, premature birth, feeding pattern, pacifier use, non-nutritive sucking habits, mouth breathing, general health issues (body posture, vision problems, frequent illness) and functional disorders (Figure 2).

Figure 2. Risk factors affecting maxillofacial region

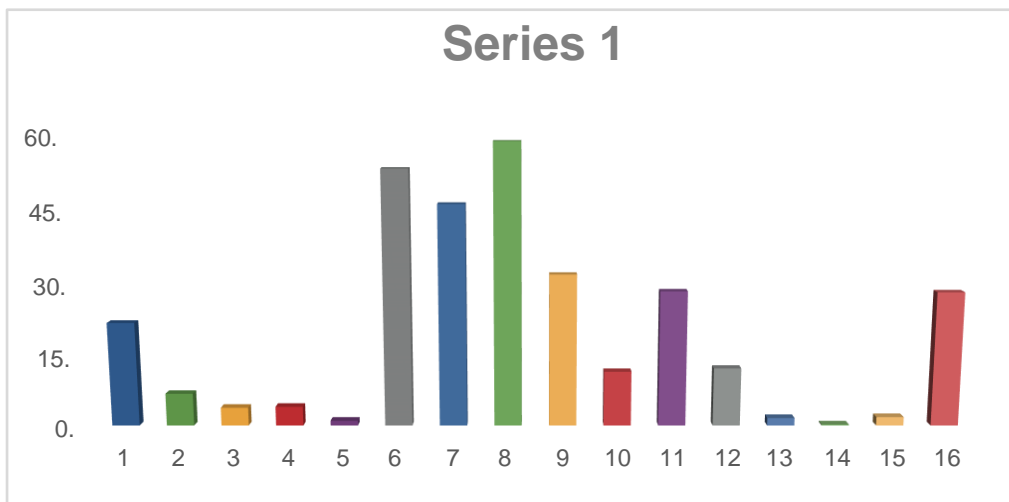

- | | |
|---------------------------------|----------------------------------|
| 1. Genetical predisposition | 9. Prolonged pacifier sucking |
| 2. Pathologies during pregnancy | 10. Bad oral habits |
| 3. Chronic diseases of mother | 11. Construction of upper airway |
| 4. Premature birth | 12. Frequent illness |
| 5. Birth trauma | 13. Psychosomatic disorders |
| 6. Breastfeeding | 14. Posture disorders |
| 7. Bottle feeding | 15. Vision problems |
| 8. Pacifier sucking | 16. Functional disorders |

Genetical predisposition was revealed in 21.8% of preschoolers with a higher correlation with Class II and Class III disorders. Prenatal issues, as abnormal pregnancy and chronic diseases of the mother, were recorded in 6.8% and 3.8% subsequently. Premature birth or birth trauma were revealed in several cases. Confirmed chronic diseases during pregnancy in 42.6% of cases was correlated with Class II, 12.9% open bite and deep bite 7.3%. Problems during pregnancy were mostly associated with Class II (30.3%) and anterior open bite (26.8%).

According to our results, breastfeeding was confirmed in 53.6% and bottle feeding in 46.4%. Most of the breastfed children did not show any signs of malocclusion, while 50.4% of the bottle-fed children had certain maxillofacial disorders. The frequency of anterior open bite was twice as high in bottle-fed children, (11%), than in breastfed children, (4.2%). Also, posterior cross bite was found in 1.5 times more in bottle-fed children. The most frequent disorder in bottle-fed children was Class II (24%), and less frequent malocclusion was Class III (1.7%), which had a higher incidence in breastfed children (3.0%).

Twelve point two percent of preschoolers mentioned frequent illness during the first three years of life, and 46.7% of them had occlusal problems. Children with frequent illness during their first three years of life had a high rate of Class II (19.7%) and anterior open bite (15.5%). Class III, crossbite and deep bite were recorded an almost equal rate (6.9%; 6.8%; 6.7%). General health issues were recorded in a minor number of cases.

According to the questionnaire, pacifier use was confirmed in 59.1%, in 31.9% of cases, they were used for more than 1.5 years. Those children

who used a pacifier for less than 1.5 years had Class II in 22.5% of cases, 12.2% had a deep overbite and 9.2% of them had an open bite. Children with a prolonged pacifier sucking habit had a rate of malocclusion at 27.9%, 10.9%, and 13.7% subsequently (Table 1).

Table 1. The frequency of pacifier sucking and prolonged pacifier sucking habit among Tbilisi Preschoolers.

| Pacifier Use | | | | | |
|--|-------|-----------|---------|---------------|--------------------|
| | | Frequency | Percent | Valid Percent | Cumulative Percent |
| Valid | Yes | 34,890 | 59.1 | 59.1 | 59.1 |
| | No | 24,157 | 40.9 | 40.9 | 100.0 |
| | Total | 59,047 | 100.0 | 100.0 | |
| Prolonged pacifier use (more than 1,5 years) | | | | | |
| | | Frequency | Percent | Valid Percent | Cumulative Percent |
| Valid | Yes | 18,841 | 31.9 | 31.9 | 31.9 |
| | No | 40,206 | 68.1 | 68.1 | 100.0 |
| | Total | 59,047 | 100.0 | 100.0 | |

The frequency of thumb sucking habit was 11.5%, with a high incidence and relative risk of an anterior open bite (25.2%; RR=4.90) (Table 2).

Table 2. Malocclusions and relatively associated risk factors.

| RR | Chronic diseases of mother | Pathologies during pregnancy | Thumb sucking |
|----------------|----------------------------|------------------------------|-----------------|
| Class II | 1.52 | 1.46 | 1.52 |
| Class III | 1.08 | 0.29 | 1.08 |
| Ant. Open bite | 4.90 | 3.11 | 4.90 |
| Deep overbite | 0.84 | 0.95 | 0.84 |
| Cross bite | 0.63 | 2.50 | 0.63 |
| RR | Pacifier sucking | Prolonged use of pacifier | Mouth breathing |
| Class II | 1.07 | 1.46 | 2.93 |
| Class III | 0.53 | 0.29 | 1.93 |
| Ant. Open bite | 1.93 | 3.11 | 1.72 |

| | | | |
|---------------|------|------|------|
| Deep overbite | 1.20 | 0.95 | 0.42 |
| Cross bite | 1.88 | 2.50 | 2.58 |

As seen in the figure 3, functional disorders were revealed in almost half of the examined preschoolers (46.9%). Based on our study, 28.2% of examined children had breathing problems, followed by speech problems at 11%, incorrect swallowing patterns (6.9%), and chewing dysfunction (0.8%).

Figure 3. Prevalence of functional disorders.

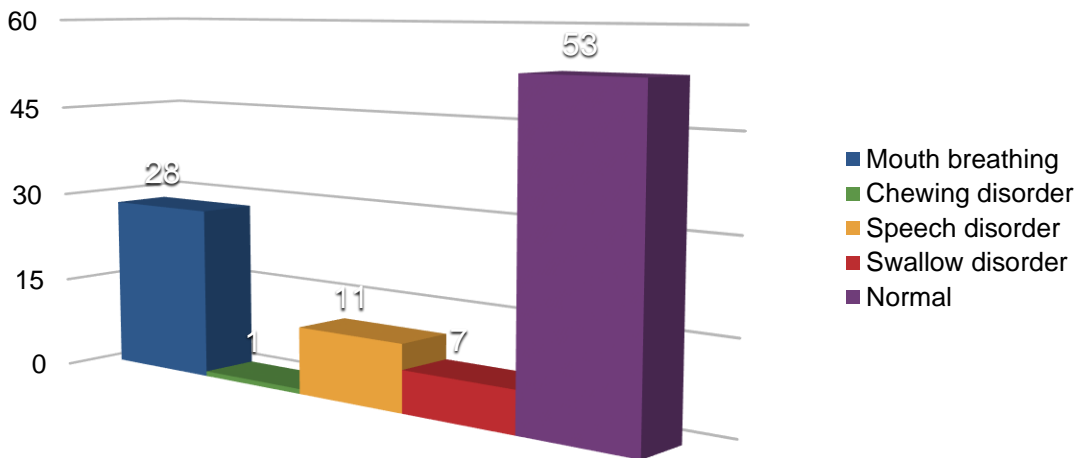

Children with breathing problems had a high prevalence of malocclusion, particularly in 41.5% Class II and the cross bite was confirmed at 13% (Figure 4). In mouth breathers, there was a higher incidence of Class II than in children with normal breathing patterns (RR=2.93). The impact of mouth breathing was also observed on the upper dental arch. In 51.2% of mouth breathers, a narrow upper arch was discovered (Figure 4). Speech disorder in 46.8% of cases was associated with anterior open bite.

Figure 4. Functional disorders and their correlation with malocclusions.

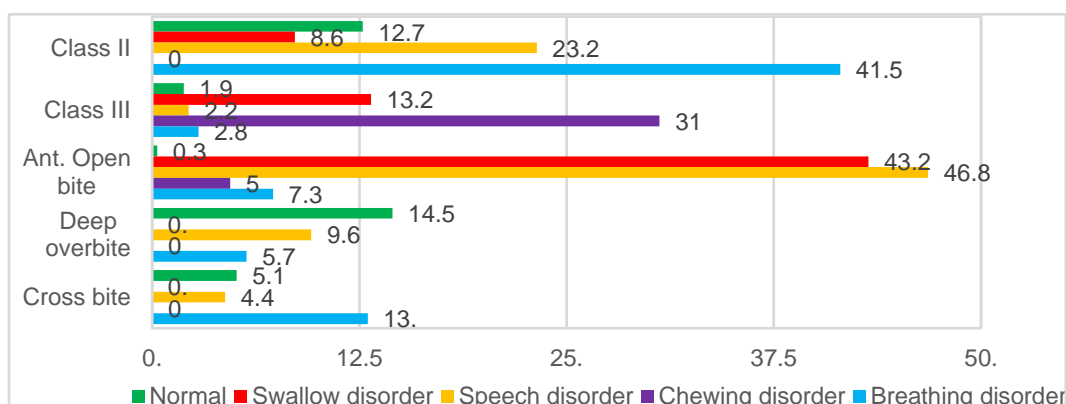

Discussion

According to the worldwide data, the prevalence of malocclusion in primary dentition varies from 21% to 88.1%, which is in line with our research that revealed occlusal anomalies in 49.8% of cases.^{13,14,15,16} The differences in values can be due to different methodologies, racial specifications, eating habits, and other characteristics.

The most frequent malocclusion, revealed in 29% of Georgian preschoolers, was Class II, with primary second molar distal step and

increased overjet, compared to Chinese and Danish children where the prevalence was 32.4% and 31.6% subsequently. They seem to be similar, but actually, there is a much higher incidence in British preschoolers(45%).¹⁵ The less frequent disorder was Class III (1.6%). However other studies revealed much higher incidence, as 6.7% and 8%.^{15,17}

A deep overbite was present in 10.7% of cases. This condition is less than that reported in other studies like Brazilian (19.7%) and German (33.2%).¹⁸

A posterior crossbite was revealed in 7% of the total sample and was mostly associated with narrow upper dental arch and mouth breathing. Bernardo Q Souki et al. have reported that the prevalence of posterior crossbite was almost 30% in children during primary and mixed dentition, which is twice as high as our result (13%).¹⁷ Anterior open bite was found in 6.9% of the total sample, as compared to other studies where the average prevalence is between 2.8 % and 46.2 %.^{14,18,19} According to Urzal V et al., anterior open bite frequency decreases from primary to mixed dentition, from 16.9% to 11.4%.⁵

Oral habit is defined as a frequent or constant practice or acquired tendency which has been fixed by frequent repetition. These habits are quite common in infancy and mainly start and stop simultaneously, but if they persist after the age of 3 years, they are considered abnormal. Parafunctional habits are acquired by practicing a nonfunctional and unnecessary action, such as pacifier, thumb or lip sucking, tongue thrust, bruxism, and mouth breathing. Persistent oral habits can affect the

normal growth of the maxillofacial region, teeth position, dental arch formation and become the reason for malocclusion development.^{20,21}

Children with oral habits (such as pacifier, digit-sucking habits, and mouth breathing) are significantly more likely to develop anterior open bite, increased overjet, Class II canine relationship and posterior crossbite as compared to children without a habit history.^{22,23}

According to the data obtained from questionnaire, 59.1% of children had used a pacifier that is quite close to the Portuguese study (61.7%). We found a statistically significant association ($p < 0.05$) between oral habits and some types of malocclusion and revealed that most children who had the pacifier sucking habit showed a tendency to Class II malocclusion, with primary second molar distal step and increased overjet (22.5%). Those who had a prolonged pacifier sucking habit (more than 1.5 years) had Class II with an anterior open bite at 27.9%. Different results were seen in the study of Urzal V et al., where children with pacifier sucking habit had more tendency to anterior open bite and posterior crossbite.⁵ Children who had a thumb-sucking habit in the past or still had it at the time of the evaluation had a high prevalence of Class II with anterior open bite (25.2%), and these data are in accordance with some other studies.⁷ In the present study, children with no NNS habits had normal molar and canine relationship, normal overjet, and overbite as in the results showed by Yvonne Wagner et al.¹³

Nasal breathing is one of the most important factors for the normal development of the maxillofacial region. Allergic rhinitis and adenotonsillar hypertrophy are the main reasons for the obstruction of airways that forces a child to breathe through the mouth.⁹ There are many

studies regarding the association between mouth breathing and maxillofacial morphology, proving that craniofacial growth can be affected by unbalanced muscular activity that is typical to mouth breathers. Evaluation of maxillofacial system functions revealed that 28.2% of examined children had breathing problems. Children with breathing problems had a high prevalence Class in II (41.5%). These results are in coincidence with other studies, where the higher incidence of Class II was considered in mouth breathers rather than Class I.²⁵

Interesting findings were observed in children who were breastfed for a prolonged time (3 years or more). They had destruction of almost all primary teeth, with severe caries and damage of almost all hard tissues of teeth, although these children had no pacifier and thumb-sucking habits, and almost none of them had malocclusion. Some studies highlight the correlation between socioeconomic factors and malocclusion. Poor perinatal health and pacifier use may be risk factors for malocclusion development in primary teeth.²⁶ Long duration of breastfeeding is associated with better occlusal conditions in the children of adolescent mothers.²⁷ However, several studies have reported prolonged and unrestricted breastfeeding as a potential risk factor for primary tooth caries (ECC).²⁸ Children with generalised primary tooth caries were generally associated with low hygiene, poor dental education of parents, and probably low-income families.

Conclusion

After evaluation of 396 Georgian preschoolers, it was possible to conclude that:

- Almost half of Tbilisi preschoolers have certain types of maxillofacial disorders which are closely associated with parafunctional activities.
- Thumb sucking and prolonged pacifier usage can cause Class II with anterior open bite.
- Mouth breathers are more prone to have Class II malocclusion.
- Thumb sucking was mostly associated with anterior open bite, prolonged pacifier use with posterior crossbite and mouth breathing with increased overjet and molar and primary canine Class II relationship.
- There is a need for raising awareness, evaluation of preventive measures, and practical recommendations for pediatric dentists, pediatricians, and other health care providers.

Acknowledgments

The authors wish to acknowledge the help provided by the head of Ivane Javakhishvili Tbilisi State University dental health department: D.M.D., PhD, D.M.Sci Vladimer Margvelashvili. We would also like to thank the staff of the Tbilisi Kindergarten Agency for their cooperation.

This research did not receive any specific grant from funding agencies in the public, commercial, or not-for-profit sectors.

References

1. Proffit, W. R., Fields, H. W., Larson, B., & Sarver, D. M. (2013). Contemporary orthodontics. Elsevier Health Sciences, pp 114-144.
2. Grippaudo, C., Paolantonio, E. G., Antonini, G., Saulle, R., La Torre, G., & Deli, R. (2016). Association between oral habits, mouth breathing and malocclusion. *Acta Otorhinolaryngologica Italica*, 36(5), 386.
3. Meyers, A., & Hertzberg, J. (1988). Bottle-feeding and malocclusion: is there an association?. *American Journal of Orthodontics and Dentofacial Orthopedics*, 93(2), 149-152.
4. Meyers, A., & Hertzberg, J. (1988). Bottle-feeding and malocclusion: is there an association?. *American Journal of Orthodontics and Dentofacial Orthopedics*, 93(2), 149-152.
5. Urzal, V., Braga, A. C., & Ferreira, A. P. (2013). Oral habits as risk factors for anterior open bite in the deciduous and mixed dentition-cross-sectional study. *European journal of paediatric dentistry*, 14(4), 299.
6. Ize-Iyamu, I. N., & Isiekwe, M. C. (2012). Prevalence and factors associated with anterior open bite in 2 to 5 year old children in Benin city, Nigeria. *African health sciences*, 12(4), 446-451.
7. Ling, H. T. B., Sum, F. H. K. M. H., Zhang, L., Yeung, C. P. W., Li, K. Y., Wong, H. M., & Yang, Y. (2018). The association between nutritive, non-nutritive sucking habits and primary dental occlusion. *BMC Oral Health*, 18(1), 145.
8. Paolantonio, E. G., Ludovici, N., Saccomanno, S., La, G. T., & Grippaudo, C. (2019). Association between oral habits, mouth breathing and malocclusion in Italian preschoolers. *European journal of paediatric dentistry*, 20(3), 204-208.
9. Grippaudo, C., Paolantonio, E. G., Antonini, G., Saulle, R., La Torre, G., & Deli, R. (2016). Association between oral habits, mouth breathing and malocclusion. *Acta Otorhinolaryngologica Italica*, 36(5), 386.

10. Fraga, W. S., Seixas, V. M., Santos, J. C., Paranhos, L. R., & Cesar, C. P. (2018). Mouth breathing in children and its impact in dental malocclusion: a systematic review of observational studies. *Minerva Stomatol*, 67(3), 129-38.
11. World Health Organization, Oral Health Assessment Form for Children, 2013
www.who.int/oral_health/publications/pep_annex2formchildrentooth.pdf?ua=1.
12. Foster T. D, Hamilton M. C. Occlusion in the primary dentition. *British Dent J*. 126(2): 76–79, 1969.
13. Wagner, Y., & Heinrich-Weltzien, R. (2015). Occlusal characteristics in 3-year-old children—results of a birth cohort study. *BMC Oral Health*, 15(1), 94.
14. Shen, L., He, F., Zhang, C., Jiang, H., & Wang, J. (2018). Prevalence of malocclusion in primary dentition in mainland China, 1988–2017: a systematic review and meta-analysis. *Scientific reports*, 8(1), 1-10.
15. Tausche, E., Luck, O., & Harzer, W. (2004). Prevalence of malocclusions in the early mixed dentition and orthodontic treatment need. *The European Journal of Orthodontics*, 26(3), 237-244.
16. Zhou, X., Zhang, Y., Wang, Y., Zhang, H., Chen, L., & Liu, Y. (2017). Prevalence of Malocclusion in 3-to 5-year-old children in Shanghai, China. *International journal of environmental research and public health*, 14(3), 328.
17. Souki, B. Q., Pimenta, G. B., Souki, M. Q., Franco, L. P., Becker, H. M., & Pinto, J. A. (2009). Prevalence of malocclusion among mouth breathing children: do expectations meet reality?. *International journal of pediatric otorhinolaryngology*, 73(5), 767-773.
18. Frazao P, Narvai PC, Latorre RM, Castellanos RA. Malocclusion prevalence in the deciduous and permanent dentition of schoolchildren in the city of São Paulo, Brazil. *Cad Saude Publica*. 2002;18(5):1197-205.

19. Chevitarese AB, Della Valle D, Moreira TC. Prevalence of malocclusion in 4-6 year old Brazilian children. *J Clin Pediatr Dent.* 2002;27(1):81-85.

20. Góis, E. G. O., Ribeiro-Júnior, H. C., Vale, M. P. P., Paiva, S. M., Serra-Negra, J. M. C., Ramos-Jorge, M. L., & Pordeus, I. A. (2008). Influence of non-nutritive sucking habits, breathing pattern and adenoid size on the development of malocclusion. *The Angle Orthodontist*, 78(4), 647-654.

21. Saccomanno, S., Antonini, G., D'Alatri, L., D'Angelantonio, M., Fiorita, A., & Deli, R. (2012). Causal relationship between malocclusion and oral muscles dysfunction: a model of approach. *European Journal of Paediatric Dentistry*, 13(4), 321-323.

22. Ize-Iyamu IN, Isiekwe MC. Prevalence and factors associated with anterior open bite in 2 to 5-year-old children in Benin City, Nigeria. *Afr Health Sci* 12: 446–51, 2012.

23. Ling H, Sum F, Zhang L, Yeung C, Li K. Y, Wong H. M, & Yang Y. The association between nutritive, non-nutritive sucking habits and primary dental occlusion. *BMC Oral Health* 18(1): 145, 2018.

24. Grippaudo C, Paolantonio EG, Antonini G, et al. Association between oral habits, mouth breathing and malocclusion. Associazione fra abitudini viziate, respirazione orale e malocclusione. *Acta Otorhinolaryngol Ital.* 2016;36(5):386-394.

25. Bernardo QS, Giovana BP, Marcelo QS, Leticia PF, Helena MG Becker, Jorge A Pinto. Prevalence of malocclusion among mouth breathing children: Do expectations meet reality?

Int J Pediatr Otorhinolaryngol 73(5):767-73, 2009.

26. Amaral CC, da Costa VPP, Azevedo MS, Pinheiro RT, Demarco FF, Goettens ML.

Perinatal health and malocclusions in preschool children: Findings from a cohort of adolescent mothers in Southern Brazil. *Am J Orthod Dentofacial Orthop* 152(5):613-621, 2017.

27. Chaffee BW, Feldens CA, Vítolo MR. Association of long-duration breastfeeding and dental caries estimated with marginal structural models. *Ann Epidemiol.* 2014;24(6):448-54.

28. Paglia L. Does breastfeeding increase risk of early childhood caries? *Eur J Paediatr Dent* 16(3):173, 2015.