

V. V. Mdzinarishvili

**NEW MODELS OF PHYSICAL
MICROWORLD AND MEGAWORLD**

**OPTIMALITY MODELS OF PHYSICAL
MICROWORLD AND MEGAWORLD**

Third edition, corrected

Tbilisi

Georgian National Academy of Sciences

2019

Reviewers:

N. Varamashvili

Academic Doctor, Chief Scientific Associate, M. Nodia Institute of Geophysics

Professor, Iv. Javakishvili Tbilisi State University

**Department of Applied Mechanics, Mechanical Engineering, Energetics and Control
Processes, Georgian National Academy of Sciences**

Scientific editor: P. Kurdadze, Dr. professor

**Dedicated to the memory of Vladimir Chavchanidze, Almaskhan Gugushvili,
Elena Shakhova, Galina Serpukhovitina providing intellectual support**

**What is reasonably that is optimal
and what is optimal that is real.**

Author

Introduction

In the epoch when the results of the experiments carried out in the physical Microworld for studying the radiation of an absolutely black body are comprehend, the data of observation of the receding Galaxies in the Megaworld were processed, such definitions and notions as the integrity of the physical system and its dissipativity were not applied, and while the variational methods were used, the equivalence of the Euler-Lagrange and Hamilton equations were not taken into consideration. However, these definitions, notions and methods are essential in modeling the processes of the Microworld and Megaworld, since they allow us to look at the optimality of those worlds from the variational position. At the same time, these definitions, notions and methods are common to Microworld and Megaworld. They make the physical Microworld and Megaworld similar.

The integrity of the system, i.e. its indivisibility into subsystems, can be interpreted on the example of the system of observations (measurements).

Let the system of observations be given by scalar equations

$$\dot{x} = -\alpha x + \xi(t), \tag{0.1}$$

$$y = x + \zeta(t), \tag{0.2}$$

of the object (0.1) and the observation channel (0.2).

In the expressions (0.1) and (0.2), $\xi(t)$ and $\zeta(t)$ are scalar random processes of the white noise type with the following stochastic characteristics:

$$E[\xi(t)] = 0, \quad E[\xi(t)\xi(t')] = \rho\delta(t - t'),$$

$$E[\zeta(t)\zeta(t')] = r\delta(t - t'), \quad E[\zeta(t)] = 0,$$

where E is the operator of mathematical expectation; δ is the Dirac function, and the parameters α, ρ, r are constant.

Introduce the following notations: $E[x(0)] = 0$, $E[x^2(0)] = \nu_0$, $\nu = E[(\hat{x} - x)^2]$, where \hat{x} is the conditional estimation of the variable x by observation y received by the method of the minimum squares, and ν is the dispersion of variable x .

In this case, the equation for dispersion ν will be given by [1]:

$$\dot{\nu} = -2\alpha\nu - (1/r)\nu^2 + \rho, \quad \nu(0) = \nu_0. \tag{0.3}$$

¹We refer equation (0.3) as Riccati equation, where the constant term is zero, i.e. $\rho = 0$

Expression (0.3) is the Riccati equation. ***The right-hand side part of (0.3) can be written in the form of a soliton***

$$\frac{dv}{dt} = -A \operatorname{sech}^2(\beta^* t - \varphi), \quad (0.4)$$

where

$$\beta^* = \sqrt{\alpha^2 + \rho/r}, \quad \varphi = \ln(\sqrt{c})^{-1}, \quad c = \frac{v_2 + v_0}{v_1 - v_0}, \quad v_1 > v_0,$$

$$v_1 = r(\beta^* - \alpha), \quad v_2 = r(\beta^* + \alpha), \quad A = D\beta^*, \quad D = \frac{v_1 + v_2}{2\sqrt{c}}.$$

Finally, as the solution of equation (0.4) allows us to determine the dispersion we have

$$v = -A \int_{t_0}^t \operatorname{sech}^2[\beta(t' - t_0) - \varphi] dt'. \quad (0.5)$$

The representation of the system of observations (measurements) as object (0.1) and the observation channel as (0.2) is formal. In natural conditions the observation system is an integral formation that cannot be divided into object (0.1) and observation channel (0.2). Observation channel (0.2) is an inherent part of observation object (0.1) [2]. Representation of a real observation system in the form of expressions (0.1) and (0.2) is rational for mathematical processing of the observation by the indirect data.

In the Megaworld there are some objects that can be described by the following equations

$$\dot{z} = mz(n - z), \quad (0.6a)$$

$$\dot{z} = -mz(n - z). \quad (0.6b)$$

Solutions for equations (0.6a) and (0.6b) are given by

$$z = \frac{1}{4} n^2 m \int_{t_0}^t \operatorname{sech}^2 \left[\frac{1}{2} mn(t' - t_0) \right] dt', \quad (0.7a)$$

$$z = -\frac{1}{4} n^2 m \int_{t_0}^t \operatorname{sech}^2 \left[\frac{1}{2} mn(t' - t_0) \right] dt'. \quad (0.7b)$$

From the even-parity property of the soliton it follows that parameter n can have a positive or a negative sign in the solutions (0.7a) and (0.7b). It should be noted that the equations (0.6a) and (0.6b) represent a particular case of equation (0.3).

Dissipative property means that the second order derivative of the dissipative function in its argument changes the sign of the dissipative function to the inverse. ***The dissipative functions are not invertible in an appropriate argument. The conservative functions are invertible: their second order derivative in its argument does not change the sign to the inverse. If the argument of function is time, then it is said that dissipative functions are not***

invertible in time, while the conservative functions are invertible. Physicists consider that the stochastic systems (in this case (0.1) and (0.2)) are not convertible. Since the equations (0.1) and (0.2) are the artificially recorded expressions corresponding to the indivisible equation (0.3), then to prove the irreversibility of equation (0.3), it is advisable to use the method of the second order derivative applicable to solution (0.5). This method gives positive answer.

The physical Microworld and Megaworld are subject to optimization¹ laws. To have an idea about those laws it is expedient to turn to the history of application of the Euler-Lagrange optimization equation and its equivalent Hamilton equation. E. Schrödinger was the first who expressed the presence of optimal property in elementary particles when he recorded his equation for the particles of the physical Microworld by means of the Hamilton function. After establishing the adequacy of modeling the Microworld processes by means of that equation, it became clear that the Microworld is based on the optimal principles. Einstein used tensor notation of the extremal property of geodesic line to create the general theory of relativity (GTR), partially modelling the optimal system of the Megaworld. Actually, it showed that a certain part of Megaworld is subjected to an optimization principle.

Now, let us determine the essence of the optimization principle dominating in the physical Microworld and Megaworld. According to this principle, under the influence of conservative forces any dynamical system moves in such a way as to minimize the average value of time difference between the kinetic and potential energies, i.e.

$$\delta \int_{t_1}^{t_2} (T - V) dt = 0$$

or

$$\int_{t_1}^{t_2} \delta L dt = 0,$$

where $T(q, p)$ is the kinetic energy;

$V(q)$ – potential energy;

$L \equiv L(q, p) = T - V$ – the Lagrange function;

q – generalized coordinate;

$p = \dot{q}$ – generalized impulse.

The variation of Lagrangian function has the following form

$$\int_{t_1}^{t_2} \delta L dt = \int_{t_1}^{t_2} \frac{\partial L}{\partial p} \delta p dt + \int_{t_1}^{t_2} \frac{\partial L}{\partial q} \delta q dt = \int_{t_1}^{t_2} \frac{\partial L}{\partial q} \delta q dt + \frac{\partial L}{\partial p} \delta q \Big|_{t_1}^{t_2} - \int_{t_1}^{t_2} \frac{d}{dt} \left(\frac{\partial L}{\partial p} \right) \delta q dt = \int_{t_1}^{t_2} \left[\frac{\partial L}{\partial q} - \frac{d}{dt} \left(\frac{\partial L}{\partial p} \right) \right] \delta q dt = 0,$$

and in the last formula it is assumed that $\delta q = 0$ when $t_1 = t$ and $t_2 = t$.

¹Further, instead of the words "variational equation", the term "optimization equation" is used, since the Euler-Lagrange variational equation was used in applied (optimization) problems.

Since the number of generalized coordinates q is equal to the number of degrees of freedom, and since δq does not depend on time, the last equation is satisfied if the expression in square brackets equals zero, i.e.

$$0 = \frac{d}{dt} \frac{\partial L}{\partial \dot{q}} - \frac{\partial L}{\partial q} \equiv \frac{dp}{dt} + \frac{\partial H}{\partial q} = 0 \Rightarrow \dot{p} = -\frac{\partial H}{\partial q}, \quad (0.8a)$$

$$0 = \frac{d}{dt} \frac{\partial L}{\partial \dot{p}} - \frac{\partial L}{\partial p} \equiv 0 - \dot{q} + \frac{\partial H}{\partial p} = 0 \Rightarrow \dot{q} = \frac{\partial H}{\partial p}, \quad (0.8b)$$

where $H = T + V$ is the Hamiltonian function (Hamiltonian). Expressions (0.8a) and (0.8b) show that the Euler-Lagrange equations are equivalent to the Hamiltonian equations representing the right-hand side part (of the equivalence symbol " \equiv ") in the expressions (0.8a) and (0.8b).

The derivative of the solution for the Riccati scalar equation (0.3) having constant coefficients represents a soliton (0.4); the integral from the soliton (see (0.5)) satisfies the Euler-Lagrange equation [3]. Thus, the solution of the Euler-Lagrange equation is a functional. This fact determines the existence of an important Euler-Lagrange equation property of invariance to arbitrary transformation of coordinates. In fact, this property turned out to be one of the prerequisites for using the optimization equation in GTR.

The optimization principles of this equation imply not only the property of invariance, but also the possibility of continuum and discrete aspects of the system modeling. Despite the glaring contrast between the physical Microworld and Megaworld, for their modeling the same optimization equations are used written in a discrete or continuous form. Application of discrete algorithms of optimization becomes necessary only if it is impossible to ignore the discreteness of the modelling particle.

Present monograph consists of two chapters. In the first chapter the new models of physical Microworld are given and corresponding optimal expressions are obtained. In the second chapter the new models of Megaworld are obtained, confirming that the world obeys the optimal laws.

Mathematical Supplements represent the inherent part of the main text and should be considered together with it as a method of a unified approach. Such a way of representation of the problems solved in the monograph was chosen as optimal for better understanding the physical sense of the problem and its mathematical interpretation.

In each paragraph of the monograph the designations have independent values.

CHAPTER 1

New models of physical Microworld and their optimality

Nothing takes place in the world whose meaning is not that of some maximum or minimum.

L. Euler

In §1.1 - §1.3, the new models of the physical Microworld are obtained. The results of these paragraphs are not interrelated in content, but they are conceptually related by means of the word "optimality". Structurally, §1.5-§1.7 are related by means of the equation of separatrix of the mathematical pendulum, and conceptually by means of the word "optimality", because there is used the optimal property of the separatrix of the pendulum, which satisfies the Hamiltonian equation.

In §1.4, the well-known conditions for a polarized light wave of the Maxwell's equations are provided allowing us to move from the microscopic study of the matter to the mesoscopic level. §1.5 shows that at the mesolevel, the stationary atoms are on the separatrix, i.e. their location is optimal. §1.6 shows that the moving atoms considered at the mesolevel move on the separatrix. This means that the moving atoms are in an optimal state.

§1.7 is of particular value, which gives an entirely new approach to GTR based on the optimal property of the separatrix of a mathematical pendulum.

§1.1. Transition to the discrete analogue of the Schrödinger equation and inverse problem solution

In the mid-twenties of the last century, Austrian physicist Erwin Schrödinger applied de Broglie's idea of an optico-mechanical analogy in the behavior of a microparticle, and basing on the Hamilton optimization principle, synthesized the basic equation of quantum mechanics bearing his name:

$$j\varepsilon \frac{\partial \Psi}{\partial t} = -\frac{1}{2} \varepsilon^2 \frac{\partial^2}{\partial x^2} \Psi + \left(\frac{U(x)}{m} \right) \Psi, \quad (1.1)$$

where $j = \sqrt{-1}$, $\varepsilon = \hbar / m$, $\hbar = 1,05459 \cdot 10^{-34} \text{ J} \cdot \text{s}$ is the Planck constant divided by 2π ;

Ψ is the wave function of the elementary particle searched for, $U(x)$ is the potential energy of a particle with m mass and coordinate x .

After obtaining equation (1.1), Schrödinger immediately applied the stationary equation (for $\dot{\Psi} = 0$) corresponding to equation (1.1) to the hydrogen atom (using a spherical coordinate system) and obtained the spectrum of the energy eigenvalues coinciding with all the known experimental data. This showed that the stationary equation correctly describes the motion of an electron in a potential electric field. Therefore, this equation was adopted as the basic equation of stationary states in quantum mechanics. The complexity of solving the stationary Schrödinger equation depends on the form of the potential energy and on the dimension of the space in which the problem is solved.

Equation (1.1) is valid for the much smaller velocity of an elementary particle than the speed of light c , i.e. for the prerelativity case. Also, equation (1.1) assumes that the motion of the particle is continuous in time.

The English theoretical physicist P. Dirac obtained the quantum mechanics equation for the relativistic analog of equation (1.1). The nonrelativistic Schrödinger equation can then be obtained as an approximation of the Dirac equation for the velocity of particle v satisfying the condition $v/c \ll 1$.

Since the matter is discrete at the microlevel, it is necessary to move from the continuous equation (1.1) to a discrete analogue. This problem is solved below [4].

For the transition from the continuous equation (1.1) to the corresponding discrete equation, it is necessary to use the system of equations of stochastic mechanics

$$\frac{\partial P}{\partial t} + \Delta \cdot (P\mathbf{v}) = 0, \quad (1.2)$$

$$\frac{\partial \mathbf{v}}{\partial t} + \mathbf{v} \cdot \Delta \mathbf{v} = \frac{\mathbf{F}}{m} + \mathbf{u} \cdot \Delta \mathbf{u} - \frac{1}{2} \varepsilon \Delta^2 \mathbf{u}, \quad (1.3)$$

$$P\mathbf{u} = -\frac{1}{2} \varepsilon \Delta P, \quad (1.4)$$

where \mathbf{v} and \mathbf{u} are the unidimensional dispersion and diffusion vectors of the particle;

$\Delta \equiv \frac{\partial}{\partial \mathbf{x}}$ is the unidimensional vector operator, and $\mathbf{F} = \frac{d}{d\mathbf{x}} U$ is the gradient of field U , i.e,

$\mathbf{F} = \mathbf{grad}U$, the dot "." denotes the scalar product.

Since, in this case, the angle between the corresponding vectors is equal to 0 degree, the point in equations (1.2) and (1.3) can be omitted, i.e. to replace the scalar product by the usual product.

It is well known that the system of equations of stochastic mechanics (1.2) – (1.4) is equivalent to equation (1.1). Therefore, to switch from equation (1.1) to the corresponding discrete equation, it is necessary to replace the continuous function of probability density $P(x, t)$ by a discrete probability density function.

If we introduce the notation

$$\Psi = \sqrt{P} \exp \left\{ \frac{j}{\varepsilon} \int \mathbf{v} \cdot d\mathbf{x} \right\}, \quad (1.5)$$

and then, taking equation (1.4) into consideration, we will have a differential relation

$$-j\varepsilon\Delta\Psi = (\mathbf{v} + j\mathbf{u})\Psi.$$

From this relation we can switch to the wave function (1.5)

$$\Psi(x, t) = e^{\frac{j}{\varepsilon} \int_{\tau_0}^t v(x, t) dx - \frac{1}{\varepsilon} \int_{\tau_0}^t u(x, t) dx}, \quad (1.6)$$

where τ_0 is the minimum time, but other than zero, i.e. $\tau_0 \neq 0$.

The discrete probability density function will be sought as a derivative of the inverse Laplace transform of the expression $\frac{1}{s} \text{th} \left(\frac{\tau_0 s}{2} \right)$, using the symbol of correspondence

" $\bullet \rightarrow \circ$ " between the Laplace transform and its original. As a result of inverse transformation we have:

$$\frac{1}{s} \text{th} \left(\frac{\tau_0 s}{2} \right) \bullet \rightarrow (-1)^{n-1}, \quad n-1 \leq \frac{t}{\tau_0} < n,$$

where $s = \sigma + j\omega$, t is the current time, $\tau_0 = \text{const}$, $n = 1, 2, \dots$. Taking into consideration equality $-1 = e^{\pi j(2k+1)}$ ($k = 0, 1, 2, \dots$) the last expression is written as follows

$$\frac{1}{s} \text{th} \left(\frac{\tau_0 s}{2} \right) \bullet \rightarrow e^{\pi j(2k+1)(n-1)\tau_0}, \quad (n-1)\tau_0 \leq t < n\tau_0.$$

Introduce notation $\tau = n\tau_0 = x$; it is clear that $t = 0$, when $n = 1$. For the case when $(n-1)\tau_0 = t$ (for $n = 2, 3, \dots$) taking into account equality $\partial\tau = \partial t$, we have relation

$$\frac{\partial}{\partial\tau} \frac{1}{s} \text{th} \left(\frac{\tau s}{2n} \right) \bullet \rightarrow \frac{\partial}{\partial t} e^{\pi j(2k+1)t}. \quad (1.7)$$

After performing the differentiation in (1.7), we obtain the expression for the probability density

$$\frac{1}{2n} \operatorname{sech}^2\left(\frac{\tau s}{2n}\right) \bullet \rightarrow \pi j(2k+1)e^{\pi j(2k+1)t} \equiv P(t, k). \quad (1.8)$$

To use formula (1.6), it is necessary to determine diffusion $u(x, t)$ and dispersion $v(x, t)$. Diffusion is found according to (1.4):

$$u = -\frac{\varepsilon}{2} \pi j(2k+1) = \text{const}. \quad (1.9)$$

Expression (1.9) is valid for any value of k . To find the dispersion v , we substitute the density $P(t, k)$, determined according to (1.8), into equation (1.2):

$$-\pi^2(2k+1)^2 e^{\pi j(2k+1)t} - v\pi^2(2k+1)^2 e^{\pi j(2k+1)t} = -\pi j(2k+1)e^{\pi j(2k+1)t} \frac{\partial v}{\partial x} \Big|: \pi j(2k+1)e^{\pi j(2k+1)t}.$$

The last expression will give the differential equation

$$\frac{\partial v}{\partial x} = -\pi j(2k+1)(v+1). \quad (1.10)$$

If we use diffusion value (1.9) in the Nelson equation (1.3), then we have equation

$$\frac{\partial v}{\partial t} + v \frac{\partial v}{\partial x} = \frac{F(x)}{m}. \quad (1.11)$$

The simultaneous solution of equations (1.10) and (1.11) leads to $2k+1$ ($k = 0, 1, 2, \dots$) number of scalar equations of Riccati type

$$\frac{\partial v}{\partial t} = \pi j(2k+1)v + \pi j(2k+1)v^2 + F(x)/m. \quad (1.12)$$

For a particular k the expression (1.12) is a scalar Riccati equation with constant coefficients; the derivative of the solution of this equation is a soliton; integral of soliton satisfies Euler-Lagrange equation.

The solution of the Riccati equation (1.12) for a particular value k has the form

$$v(x, t) = v_1(x) + \frac{v_1(x) + v_2(x)}{\left(\frac{v_0(x) + v_2(x)}{v_0(x) - v_1(x)}\right) e^{2\beta(x)t} - 1}, \quad (1.13)$$

where

$$\beta(x) \equiv \beta(jx) = \sqrt{-\frac{\pi^2}{4}(2k+1)^2 - j\pi(2k+1)\frac{F(x)}{m}}, \quad (0.13a)$$

$$\nu_1(x) \equiv \nu_1(jx) = -[j\pi(2k+1)]^{-1} \left[\beta(x) + j\frac{\pi}{2}(2k+1) \right], \quad (1.13b)$$

$$\nu_2(x) \equiv \nu_2(jx) = -[j\pi(2k+1)]^{-1} \left[\beta(x) - j\frac{\pi}{2}(2k+1) \right], \quad (1.13c)$$

and $\nu_0 = \nu(x, 0)$ is the value of dispersion for $t = 0$. For solution of equation (1.12), we can assume $\nu_0 = 0$. Then the solution of equation (1.12) can be written in the following form [5]:

$$\nu(x, t) = D(x) \beta(x) \int_0^{\infty} \operatorname{sech}^2[\beta(x)t - \varphi(x)] dt, \quad (1.14)$$

$$\text{where } D(x) = \frac{\nu_1(x) + \nu_2(x)}{2\sqrt{c}}, \quad c = \frac{\nu_2(x)}{\nu_1(x)}, \quad \varphi(x) = \ln(\sqrt{c})^{-1}.$$

The functional (1.14) determining dispersion $\nu(x, t)$ over a time interval $t \in (0, \infty)$ depends on the particle coordinate in a complex way; therefore, the substitution of the dispersion $\nu(x, t)$ in the formula of wave function (1.6) greatly complicates computation of this function, making this calculation practically impossible. However, for determining the dispersion $\nu(x, t)$ in the stationary case, i.e. when $t = \infty$, and at the initial moment, when $t = 0$, calculation of the dispersion becomes possible.

Indeed, when $t = \infty$, according to formula (1.13), we have $\nu(x) = \nu_1(x)$, if $t = 0$, then from (1.13) we get $\nu(x) = 0$. Consequently, the calculation of the integral (1.14) in the stationary state and at the initial moment will be given by:

$$\nu \left(x, t = \begin{matrix} \infty \\ 0 \end{matrix} \right) = \nu(x) = \nu_1(x) - 0 = \nu_1(x). \quad (1.15)$$

According to formula (1.13b), the expression (1.15) will be written as follows:

$$\nu(x) = \nu_1(x) = -[j\pi(2k+1)]^{-1} \beta(x) - \frac{1}{2}. \quad (1.16)$$

If in formula (0.13a) we take the term $-\frac{\pi^2}{4}(2k+1)^2$ out of the radical sign, then we have

$$\beta(x) = j\frac{\pi}{2}(2k+1) \sqrt{1 + j\frac{4}{\pi m(2k+1)} F(x)}. \quad (1.17)$$

If we take into consideration (1.17) in expression (1.16), then we have

$$\nu(x) = -\frac{1}{2} \sqrt{1 + j\alpha F(x)} - \frac{1}{2} = -\frac{1}{2} \sqrt{1 + jz(x)} - \frac{1}{2}, \quad (1.18)$$

where $\mathfrak{x} = \frac{4}{\pi m(2k+1)}$, $z(x) = \mathfrak{x}F(x)$.

Taking into consideration

$$\sqrt{1+jz} = \pm \left[\sqrt{\frac{r+1}{2}} + j\sqrt{\frac{r-1}{2}} \right], \quad r = \sqrt{1+z^2}, \quad (1.17a)$$

expression (1.17) will be written as follows:

$$\beta(x) = \pm [j\eta(x) - \gamma(x)],$$

$$\text{where } \eta(x) = \frac{\pi}{2}(2k+1)\sqrt{\frac{r+1}{2}}, \quad \gamma(x) = \frac{\pi}{2}(2k+1)\sqrt{\frac{r-1}{2}}.$$

According to (1.6), the operations with account of expressions (1.9) and (1.18) will be performed in exponential degree; the exponential degree has the following form:

$$-\frac{j}{2\varepsilon} \int_{\tau_0}^{n\tau_0} \sqrt{1+jz(x)} dx - \frac{j}{2\varepsilon} \int_{\tau_0}^{n\tau_0} dx + \frac{1}{2} j\pi(2k+1) \int_{\tau_0}^{n\tau_0} dx. \quad (1.19)$$

For $(jz)^2 \leq 1$ the expression $(1+jz(x))^{1/2} \leq 1$ can be expanded into binomial series

$$\sqrt{1+jz(x)} = 1 + j\frac{1}{2}z + \frac{1 \cdot 1}{2 \cdot 4}z^2 - j\frac{1 \cdot 1 \cdot 3}{2 \cdot 4 \cdot 6}z^3 - \dots \quad (1.20)$$

We confine ourselves to the first three terms of expansion (1.20) and calculate the integrals in expression (1.19); then the integration of the partition terms of the sum (1.19), without taking into consideration coefficient $\frac{1}{2}$, will give

$$1. -\frac{j}{\varepsilon} \int_{\tau_0}^{n\tau_0} dx = -\frac{j}{\varepsilon}(n\tau_0 - \tau_0) = -\frac{j}{\varepsilon}(n-1)\tau_0 = -j\alpha_1(n\tau_0),$$

$$2. -\frac{j}{\varepsilon} \int_{\tau_0}^{n\tau_0} \left(j\frac{1}{2}\mathfrak{x} \left(\frac{dU}{dx} \right) \right) dx = \frac{1}{2} \cdot \frac{\mathfrak{x}}{\varepsilon} \int_{\tau_0}^{n\tau_0} dU(x) = \frac{1}{2} \cdot \frac{\mathfrak{x}}{\varepsilon} (U(n\tau_0) - U(\tau_0)) = \alpha_2(n\tau_0),$$

$$3. -\frac{j}{\varepsilon} \int_{\tau_0}^{n\tau_0} \left(\frac{1}{8}\mathfrak{x}^2 \left(\frac{dU}{dx} \right)^2 \right) dx = -j\alpha_3(n\tau_0),$$

$$4. -\frac{j}{\varepsilon} \int_{\tau_0}^{n\tau_0} dx = -\frac{j}{\varepsilon}(n\tau_0 - \tau_0) = -\frac{j}{\varepsilon}(n-1)\tau_0 = -j\alpha_4(n\tau_0) \equiv -j\alpha_1(n\tau_0),$$

$$5. j\pi(2k+1) \int_{\tau_0}^{n\tau_0} dx = j\pi(2k+1)(n\tau_0 - \tau_0) = j\pi(2k+1)(n-1)\tau_0 = j\alpha_5(n\tau_0).$$

The substitution of the values $-j\alpha_1, \alpha_2, -j\alpha_3, -j\alpha_4, j\alpha_5$ into the sum (1.19), and then taking this sum into consideration in (1.6), allows us to determine the discrete wave function

$$\Psi(n\tau_0) = e^{\frac{1}{2}\{(\alpha_2(n\tau_0) - j[2\alpha_1(n\tau_0) + \alpha_3(n\tau_0) - \alpha_5(n\tau_0)])\}}, \quad n = 2, 3, \dots \quad k = const, \quad (1.21)$$

which is the solution of the discrete analogue of the Schrödinger equation.

The parameter k defined from the condition $\varepsilon(k)=1$ with following make to round off the next whole number.

By means of formula (1.21) the inverse problem is solved: on certain wave function the potential energy of a particle having little proper time τ_c is determined. Such objects are: isotope of polonium $^{238}P_0$ having period with half-decay $\tau_c = 3 \cdot 10^{-7}$ s, lifetime atom of a hydrogen in condition $2P_{1/2}$ equally $\tau_c = 1,6 \cdot 10^{-9}$ s, lifetime atom of a hydrogen in condition $2S_{1/2}$, equally $\tau_c = 0,14$ s and so forth. Thus, for example, potential energy of particle is determined from the equality $e^{\frac{1}{2}\alpha_2^*} = \tau_c$, and superposable restrictions for the energy of the particle is found from the expression $\alpha_5 - \alpha_3^* - 2\alpha_1 = 0$, where $\alpha_i^* = \alpha_i|_{\varepsilon(k)=1}$, $i=2,3$.

Transition from equation (1.1) to the discrete analogue is carried out by taking into account $t = \tau_0(n-1)$ and $x = n\tau_0$ in equation (1.1). The quantization time τ_0 must be much lesser than the proper time, i.e. $\tau_0 \ll \tau_c$.

The above results can be used to justify the phenomenon of "birth out of nothing" (i.e, from virtual particles) of the real particles occurring in a strong gradient of electric field [2].

To determine the gradient of the electric field at which real particles are formed from virtual particles, we use formula (1.17a) instead of the first term of the expression (1.19). In this case, without taking into consideration coefficient 1/2 we have

$$-j \int_{\tau_0}^{n\tau_0} \left\{ \pm \frac{1}{\varepsilon} \left[\sqrt{\frac{r+1}{2}} + j \sqrt{\frac{r-1}{2}} \right] + \frac{1}{\varepsilon} - \pi(2k+1) \right\} dx. \quad (1.22)$$

After multiplying expression (1.22) by $-j$, in formula (1.22) we will have imaginary and non-imaginary terms separately

$$\int_{\tau_0}^{n\tau_0} \left\{ \left[\pm \frac{1}{\varepsilon} \sqrt{\frac{r-1}{2}} \right] - \left[\pm \frac{j}{\varepsilon} \sqrt{\frac{r+1}{2}} \right] - \frac{j}{\varepsilon} + j\pi(2k+1) \right\} dx. \quad (1.23)$$

In the case when there are no virtual particles, the sum of the coefficients for imaginary terms must be zero in expression (1.23), i.e.

$$-\frac{1}{\varepsilon} \left[\pm \sqrt{\frac{r+1}{2}} \right] - \frac{1}{\varepsilon} + \pi(2k+1) = 0, \quad r = \sqrt{1 + \alpha^2 F^2}. \quad (1.24)$$

If there are no virtual particles, then we have only the real particles.

Since , then it follows from (1.24) that

$$\sqrt{1 + \alpha^2 F^2} = G, \quad (1.25)$$

where $G = 1 - 4\pi\varepsilon(2k+1) + 2\pi^2\varepsilon^2(2k+1)^2$.

From (1.25) we find the gradient of the electric field where the real particles appear

$$F = \left| \pm \frac{1}{\alpha} \sqrt{G^2 - 1} \right|. \quad (1.26)$$

In formula (1.26) the sign of the absolute value is conditioned by the fact that the

expression $z = \frac{4F}{\pi m(2k+1)}$ is positive and, consequently, $F > 0$.

Dimensional of intensity of the electrical field is $[F] = \frac{g^{1/2}}{(cm)^{1/2} \cdot s}$.

We receive the final result of formation of real particles "out of nothing" if in expression (1.23) we take into consideration (1.24), and also take into consideration formula (1.21) and denotation $\tau_0(n-1) = t$:

$$\Psi(k, t) = e^{\frac{t}{2\varepsilon} \sqrt{\frac{r(k)-1}{2}}}, \quad k = 0, 1, 2, \dots \quad t = const. \quad (1.26')$$

Thus, transition from the continuous equation (1.1) to the discrete equation allowed to obtain a discrete wave function (1.21), and also to determine the field gradient (1.26) where according to formula (1.26') the real particles are formed.

§1.2. Knots and binary functions. The optimality frequencies at which the binary functions are formed

Knots can be formed only in the space of dimension "three". To avoid difficulties for representation of knots in three-dimensional space, the projections of knots on the plane are considered. Besides, the axiom about line proposed by Euclid, which states that the line is a "breadthless length", is taken into consideration.

As a result of ordering the number of knots with less than 10 intersections on their projections, 105 knots were identified; some of them (35 knots) are shown in Fig. 1.

In Fig. 1 the knots are arranged in the increasing order of the minimum quantily of intersections on their projections. If there are several different knots with the same quantily of intersections, they are grouped together and each of them receives an additional index apart from the quantily of intersections. For example, the first figure (three-leaved figure) has three intersections and it is just one with so many intersections, the refore it is denoted by 3_1 .

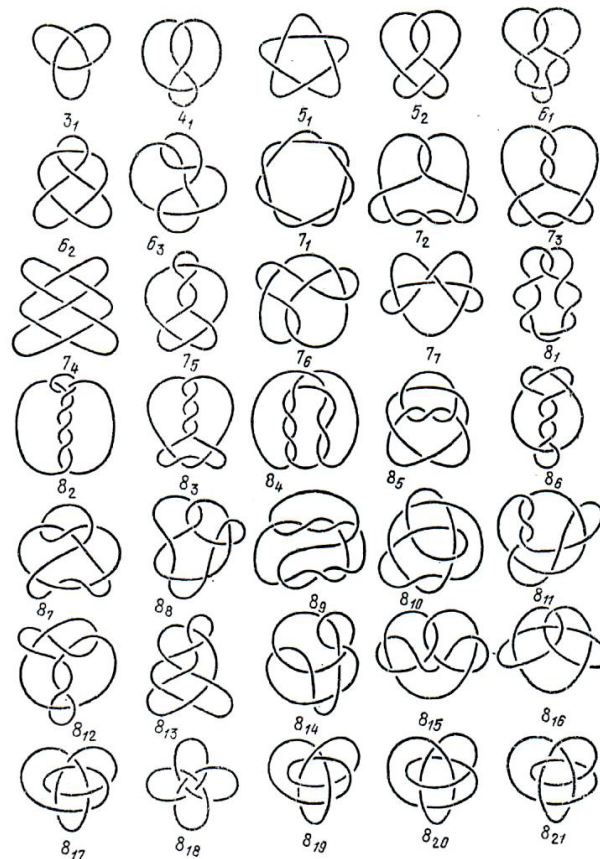

Fig.1

The second figure (figure of eight) has four intersections; it is the only one with such a quantily of intersections, therefore, it is denoted by 4_1 etc. Now, let us determine the principle of the change of the quantily of intersections into the number of knots. Table 1 built according to Fig. 1 [6] shows the dependence of the number of knots on the quantily of intersections:

Table 1

Number of knots	Quantily of intersections	Quantily of intersections	Quantily of intersections	Quantily of intersections	Quantily of intersections	Quantily of intersections
	3	4	5	6	7	8
W_i	1	1	2	3	7	21

Table 1 shows that the number of the first four knots with the same quantily of intersections subjects to the principle of Fibonacci sequence, for which the recurrence relation holds:

$$U_i = U_{i-1} + U_{i-2}, \quad i = 1, 2, 3, 4. \quad (1.27)$$

It can be noted that the next value, i.e. the fifth (see Fig. 1) one V_5 with 7 intersections is defined as the sum of the number of all previous knots

$$V_5 = \sum_{i=1}^4 U_i = 7 \quad (1.28)$$

As a result of extrapolation of the data given in Table 1, we obtain a recurrent formula for the number of knots with the same quantily of intersections:

$$V_i = 2V_{i-1} + 7, \quad i = 5, 6, 7, \dots, \quad (1.29)$$

Thus, the sequence of the number of knots with the same quantily of intersections W consists of two sequences (1.27) and (1.29); formula (1.28) is a link between these sequences. Thus, we have a sequence of the number of knots with the same quantily of intersections

$$W_i = \begin{cases} U_i & \text{for } i < 5, \quad i = 1, 2, 3, 4, \\ V_i & \text{for } i \geq 5, \quad i = 5, 6, 7, \dots \end{cases} \quad (1.30)$$

Consequently, if we introduce denotation $\ell = n + 4(n = 1, 2, \dots)$, then according to formula (1.29), the number of knots V_ℓ with ℓ quantily of intersections can be represented as a row matrix

$$V_\ell = 7 \parallel 1 \quad 3 \quad 7 \quad 15 \quad 31 \quad 63 \quad \dots \parallel. \quad (1.31)$$

Matrix (1.31) can be written in the following form:

$$V_\ell = 7 \parallel 2^1 - 1 \quad 2^2 - 1 \quad 2^3 - 1 \quad 2^4 - 1 \quad 2^5 - 1 \quad 2^6 - 1 \quad \dots \parallel. \quad (1.31a)$$

Each element in matrix(1.31a) can be represented as a particular solution of the difference equation

$$V_m = (1 + r)V_{m-1} + V_0$$

for $r = 1$ and $V_0 = 7$. The solution has the following form:

$$V_m = \frac{V_0}{r} [(1 + r)^{m+1} - 1],$$

where $m = 0, 1, 2, \dots$

Now, let us define the notion of the quantum system (QS). A characteristic feature of QS is that a particle in it can have only two values, conventionally denoted as 1 and 0 or +1 and

-1 i.e. it represents a binary function. An infinite (in time) sequence of binary functions form quantum-mechanical functions (QMF).

Consider the function of pure delay, i.e. piecewise-constant function, shown in Fig. 2a.

The Laplace transform of this function can be written as follows:

$1 - e^{-\tau s}$, where $s = \sigma + j\omega$, $\sigma > 0$, $j = \sqrt{-1}$. Variation of this function on the interval $[0, 2\tau]$ of a semi-infinite time axis ($t \in [0, \infty)$) is shown in Fig. 2b.

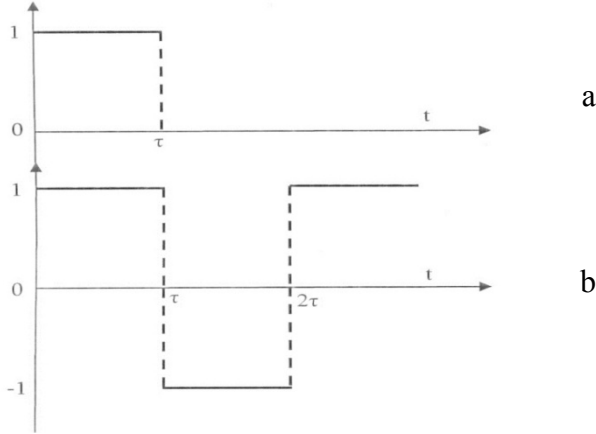

Fig. 2

Laplace transform of variation of that function over the entire semi-infinite time axis has the following form

$$D_0(\tau s) = \frac{1 - e^{-\tau s}}{1 + e^{-\tau s}} = \text{th}\left(\frac{\tau s}{2}\right). \quad (1.32)$$

Let us now consider variation of other functions, $(1 - e^{-\tau s})^2$, $(1 - e^{-\tau s})^3$, $(1 - e^{-\tau s})^4$ etc. over the whole semi-infinite time axis and express that variation through the Laplace transform of the binary function (1.32) that will give the following QMF¹:

$$D_1(\tau s) = \frac{(1 - e^{-\tau s})^2}{1 + e^{-2\tau s}} = \frac{2\text{th}^2\left(\frac{\tau s}{2}\right)}{1 + \text{th}^2\left(\frac{\tau s}{2}\right)}, \quad (1.33)$$

$$D_2(\tau s) = \frac{(1 - e^{-\tau s})^3}{1 + e^{-3\tau s}} = \frac{2^2 \text{th}^3\left(\frac{\tau s}{2}\right)}{1 + 3\text{th}^2\left(\frac{\tau s}{2}\right)}, \quad (1.34)$$

¹Further Laplace transform is mentioned as QMF.

$$D_3(\tau s) = \frac{(1 - e^{-\tau s})^4}{1 + e^{-4\tau s}} = \frac{2^3 \operatorname{th}^4\left(\frac{\tau s}{2}\right)}{1 + 6\operatorname{th}^2\left(\frac{\tau s}{2}\right) + \operatorname{th}^4\left(\frac{\tau s}{2}\right)}, \quad (1.35)$$

$$D_4(\tau s) = \frac{(1 - e^{-\tau s})^5}{1 + e^{-5\tau s}} = \frac{2^4 \operatorname{th}^5\left(\frac{\tau s}{2}\right)}{1 + 10\operatorname{th}^2\left(\frac{\tau s}{2}\right) + 5\operatorname{th}^4\left(\frac{\tau s}{2}\right)}, \quad (1.36)$$

$$D_5(\tau s) = \frac{(1 - e^{-\tau s})^6}{1 + e^{-6\tau s}} = \frac{2^5 \operatorname{th}^6\left(\frac{\tau s}{2}\right)}{\left[1 + \operatorname{th}^2\left(\frac{\tau s}{2}\right)\right] \left[1 + 14\operatorname{th}^2\left(\frac{\tau s}{2}\right) + \operatorname{th}^4\left(\frac{\tau s}{2}\right)\right]} =$$

$$= \frac{2^5 \operatorname{th}^6\left(\frac{\tau s}{2}\right)}{1 + 15\operatorname{th}^2\left(\frac{\tau s}{2}\right) + 15\operatorname{th}^4\left(\frac{\tau s}{2}\right) + \operatorname{th}^6\left(\frac{\tau s}{2}\right)}, \quad (1.37)$$

$$D_6(\tau s) = \frac{(1 - e^{-\tau s})^7}{1 + e^{-7\tau s}} = \frac{2^6 \operatorname{th}^7\left(\frac{\tau s}{2}\right)}{1 + 35\operatorname{th}^2\left(\frac{\tau s}{2}\right) + 21\operatorname{th}^4\left(\frac{\tau s}{2}\right) + 7\operatorname{th}^6\left(\frac{\tau s}{2}\right)}, \quad (1.38)$$

$$D_7(\tau s) = \frac{(1 - e^{-\tau s})^8}{1 + e^{-8\tau s}} = \frac{2^7 \operatorname{th}^8\left(\frac{\tau s}{2}\right)}{1 + 28\operatorname{th}^2\left(\frac{\tau s}{2}\right) + 70\operatorname{th}^4\left(\frac{\tau s}{2}\right) + 28\operatorname{th}^6\left(\frac{\tau s}{2}\right) + \operatorname{th}^8\left(\frac{\tau s}{2}\right)}, \quad (1.39)$$

etc.

Formulas (1.33) -- (1.39) have definite properties.

1) The number of terms in the denominator of formulas (1.33) -- (1.39) in each subsequent pair varies by one. Thus, in pair 1, number of 2 terms is 2, in pair 3, number of 4 terms is 3, in pair 5, number of 6 terms is 4, in pair 7, number of 8 terms is 5, etc.

2) In the denominator of the QMF (formulas (1.33) – (1.39)) there is a certain number of parts of the binomial coefficients; the sum of all the coefficients in the denominator QMF (for $\operatorname{th}\left(\frac{\tau s}{2}\right) = \pm 1$) is equal to 2^n : $C_1^0 + C_1^1 = 2^1$, $C_3^0 + C_3^1 = 2^2$, $C_4^0 + C_4^2 + C_4^4 = 2^3$,

$$C_5^0 + C_5^2 + C_5^4 = 2^4, \quad C_6^0 + C_6^2 + C_6^4 + C_6^6 = 2^5, \quad C_7^0 + C_7^3 + C_7^2 + C_7^1 = 2^6,$$

$$C_8^0 + C_8^2 + C_8^4 + C_8^6 + C_8^8 = 2^7, \dots$$

$$\sum_{\nu=0}^n C_{\mu(n)}^{\nu(n)} = 2^n, \quad \mu(n) = 1, 3, 4, 5, \dots; \quad \nu(n) = 0, 1, 2, \dots$$

where n is the number of the QMF, and the symbol $C_{\mu(n)}^{\nu(n)}$ denotes the number of combinations from μ to ν .

Since the discrete power function 2^n appears in the numerators of the QMF, then the subtraction of 1 from it can give the corresponding element of the row matrix (1.31a). Thus, the whole row matrix (1.31a) is constructed the same way; its every element multiplied by 7 shows the number of knots, which have the same quantity of intersections.

In order to prove the optimality of the frequencies the QS, we consider Riccati's quantum equation

$$\frac{d\Gamma(\tau s)}{d\tau} = \sigma\Gamma(\tau s) - s\sigma\Gamma^2(\tau s) \quad (1.40)$$

where

$$\Gamma(\tau s) = \frac{1}{s} \operatorname{th}\left(\frac{\tau s}{2}\right). \quad (1.41)$$

The derivative with respect to τ in the solution of Riccati's quantum equation (1.40) is a soliton that satisfies the corresponding Euler-Lagrange optimization equation.

Substitution of denotation (1.41) into equation (1.40) leads to equation

$$\left(\frac{\sigma}{s} - \frac{1}{2}\right) \operatorname{th}^2\left(\frac{\tau s}{2}\right) - \frac{\sigma}{s} \operatorname{th}\left(\frac{\tau s}{2}\right) + \frac{1}{2} = 0. \quad (1.42)$$

The solution of equation (1.42) has the following roots:

$$\operatorname{th}\left(\frac{\tau s}{2}\right)_1 = 1 \quad \text{and} \quad \operatorname{th}\left(\frac{\tau s}{2}\right)_2 = \frac{s}{2\sigma - s}. \quad (1.43)$$

The first root shows that equation (1.40) is satisfied by the Laplace transform of the Dirac δ – function.

The roots (1.43) are unsuitable for establishing the binarity of the QMF.

However, if we have $\sigma = 0$ in the second root and assume that $\omega \neq 0$, then we receive root $\operatorname{th}\left(\frac{\tau j\omega}{2}\right)_2 = -1$ that is suitable for establishing the binarity of the QMF. In this case, there is no real part in the Laplace transforms (1.32) – (1.39).

Indeed, the substitution of $\operatorname{th}\left(\frac{\tau j\omega}{2}\right)_2 = -1$ in (1.33) – (1.39) gives

¹s is considered as a parameter independent from the variable τ .

$$D_1 = D_3 = D_5 = D_7 = +1$$

and

$$D_2 = D_4 = D_6 = -1.$$

These expressions confirm the existence of the binary QMF.

Let us determine the frequencies, where QMF is binary. We have

$$\text{th}\left(j \frac{\tau\omega_{\pm}}{2}\right) = \pm 1 \quad \text{or} \quad \text{jtg}\left(\frac{\tau\omega_{\pm}}{2}\right) = \pm 1 \Rightarrow \text{tg}\left(\frac{\tau\omega_{\mp}}{2}\right) = \mp j.$$

Let us find j and $-j$. If $-1 = e^{\pi j(2k+1)}$, then $j = e^{\frac{\pi}{2}j(2k+1)}$ and $-j = e^{\frac{3\pi}{2}j(2k+1)}$. With account of Euler formula $e^{jx} = \cos x + j \sin x$, from relation $\text{tg}\left(\frac{\tau\omega_{\mp}}{2}\right) = \mp j$ we have the desired frequencies:

$$\omega_{-}(k) = \frac{2}{\tau} \text{Arctg} \left\{ \text{tg}\left(\frac{\tau\omega_{-}}{2}\right) \sin \left[\frac{3\pi}{2}(2k_{-1}+1) \right] \right\} : \omega_{-}(k), \quad k_{-1} = \frac{2\alpha}{3}, \quad \alpha = 1, 2, 3, \dots$$

From the last formula we have

$$D_{2\alpha} = \sin \left[\frac{3\pi}{2}(2k_{-1}+1) \right], \quad k_{-1} = \frac{2\alpha}{3}, \quad \alpha = 1, 2, 3, \dots$$

$$\omega_{+}(k) = \frac{2}{\tau} \text{Arctg} \left\{ \text{tg}\left(\frac{\tau\omega_{+}}{2}\right) \sin \left[\frac{\pi}{2}(2k_{+1}+1) \right] \right\} : \omega_{+}(k), \quad k_{+1} = 2\alpha, \quad \alpha = 1, 2, 3, \dots$$

Similarly, from the last expression we receive

$$D_{2\alpha-1} = \sin \left[\frac{\pi}{2}(2k_{+1}+1) \right], \quad k_{+1} = 2\alpha, \quad \alpha = 1, 2, 3, \dots$$

Consequently, at frequencies of ω_{-} and ω_{+} the condition of binarity of QMF is satisfied.

The frequencies $\omega_{-} \equiv \frac{3\pi}{2}(2k_{-1}+1)$ and $\omega_{+} \equiv \frac{\pi}{2}(2k_{+1}+1)$ are optimal, since they (for $\sigma=0$) follow directly from representation (1.42) of Riccati's quantum equation (1.40), the left-hand side part of which (soliton) satisfies the Euler-Lagrange optimization equation.

§ 1.3. The optimality characteristic of Fermi-Dirac gas

For a Fermi-Dirac gas consisting of N particle we have the relation

$$\sum_i \langle N(E_i) \rangle = \sum \frac{1}{e^{(E_i - \mu)/kT} + 1} = N,$$

where the summation is carried out on all permitted values of energy E_i of the particle; chemical potential μ for the fermions can be either positive or negative depending on the properties and state of the system, i.e., $\mu \leq 0$. The value of chemical potential $\mu(T=0)$ is the

maximum energy of a particle in Fermi-Dirac gas for $T = 0$; k and T are the Boltzmann constant and the absolute temperature, respectively.

In quantum theory, there is a principle of identity of identical particles forming the given quantum-mechanical system; according to this principle, all identical particles are completely same. These particles do not interact with each other; therefore, the total energy of the system is equal to the sum of the energies of individual states of the particles

$$E = E_1 + E_2 + \dots + E_n = \sum_{i=1}^n E_i.$$

The law of distribution

$$N(E_n) = \frac{1}{e^{(E-\mu)/kT} + 1} \quad (1.44)$$

is called the Fermi-Dirac distribution, and the aggregate of particles described by this law is the Fermi-Dirac gas.

The derivative of the distribution (1.44) is the distribution density; the normalized density is denoted by

$$L(E) = \left(\frac{1}{e^{(E-\mu)/kT}} \right)'_E \cdot (-4kT) = \operatorname{sech}^2 \left[\frac{\lambda}{2} (E - E_0) \right], \quad (1.45)$$

where $\lambda = 1/kT$, $E_0 = \mu$.

The Euler-Lagrange equation for the normalized density (1.45) of a Fermi-Dirac gas has the form [7]

$$\frac{\partial L}{\partial y} - \frac{\partial}{\partial E} \frac{\partial L}{\partial (\partial y / \partial E)} = 0, \quad (1.46)$$

where

$$y = \operatorname{sech} \left[\frac{\lambda}{2} (E - E_0) \right] \text{ and } y \text{ corresponds to the coordinate } q, \text{ and } \frac{\partial y}{\partial E} \text{ - to impulse } p.$$

In equation (1.46), in comparison with the Euler-Lagrange equation, the operator $\frac{d(\cdot)}{dt}$ is replaced by an operator $\frac{\partial(\cdot)}{\partial E}$, and the structure of equation (1.46) is the same as that of the Euler-Lagrange equations.

In its unfolded form, equation (1.46) can be written as follows

$$L_y - L_{Ey'} - L_{yy'} \cdot y' - L_{y'y'} \cdot y'' = 0. \quad (1.46a)$$

In equation(1.46a), we have the following values, which include the terms [5]:

$$L_y \equiv L_{Ey'} = 2 \operatorname{sech} \left[\frac{\lambda}{2} (E - E_0) \right], \quad (1.47)$$

$$L_{yy'} \cdot y' = 2 \operatorname{sech} \left[\frac{\lambda}{2} (E - E_0) \right], \quad (1.48)$$

$$L_{yy'} \cdot y'' = \frac{\operatorname{sech} \left[\frac{\lambda}{2} (E - E_0) \right]}{\operatorname{th}^2 \left[\frac{\lambda}{2} (E - E_0) \right]} \left\{ 1 - 2 \operatorname{sech}^2 \left[\frac{\lambda}{2} (E - E_0) \right] \right\}, \quad (1.49)$$

The substitution of the values (1.47) – (1.49) in equation (1.46a) with account $\operatorname{sech} \left[\frac{\lambda}{2} (E - E_0) \right] \neq 0$ gives the following equation:

$$2 \operatorname{th}^2 \left[\frac{\lambda}{2} (E - E_0) \right] + 1 - 2 \operatorname{sech}^2 \left[\frac{\lambda}{2} (E - E_0) \right] = 0.$$

From this equation we have

$$L \equiv \operatorname{sech}^2 \left[\frac{\lambda}{2} (E - E_0) \right] = \frac{3}{4}. \quad (1.50)$$

What is the condition that the density function of the Fermi-Dirac gas (1.44) must satisfy in order this density had an optimal property? To answer this question, we define the second derivative of expression (1.44) for the energy

$$(L(E))_E'' = \lambda^2 \operatorname{sech}^2 \left[\frac{\lambda}{2} (E - E_0) \right] \left\{ \frac{3}{2} \operatorname{sech}^2 \left[\frac{\lambda}{2} (E - E_0) \right] - 1 \right\}. \quad (1.51)$$

Let us find a condition under which the value of function L (1.50) becomes minimum. That would happen if function (1.51) is positive and consequently satisfies the condition

$$\frac{3}{2} \operatorname{sech}^2 \left[\frac{\lambda}{2} (E - E_0) \right] - 1 > 0.$$

This inequality results in the condition

$$\operatorname{sech}^2 \left[\frac{\lambda}{2} (E - E_0) \right] > \frac{2}{3}. \quad (1.52)$$

Condition (1.52) does not contradict equality (1.50). This means that the state L (1.50) is the minimum for the density of the Fermi-Dirac gas.

We use the relation $\operatorname{th}^2(\alpha) = 1 - \operatorname{sech}^2(\alpha)$ for the transition from the function (1.50) to the function of the square of the hyperbolic tangent:

$$\operatorname{th}^2 \left[\frac{\lambda}{2} (E - E_0) \right] = \frac{1}{4}.$$

From this equality we have two roots

$$\text{th}\left[\frac{\lambda}{2}(E-E_0)\right]_1 = \frac{1}{2} \quad \text{and} \quad \text{th}\left[\frac{\lambda}{2}(E-E_0)\right]_2 = -\frac{1}{2}.$$

From the first root $\text{th}\left[\frac{\lambda}{2}(E-E_0)\right]_1 = \frac{1}{2}$ it is not difficult to find the energy of the field of

Fermi-Dirac gas: $E = kT \ln 3 + kTE_0$.

The Lagrange function (Lagrangian) satisfies the Euler-Lagrange equation and, consequently, the parameters of the Fermi-Dirac gas found by solving the Euler-Lagrange equation are optimal.

According to the second root, $\left(\text{th}\left[\frac{\lambda}{2}(E-E_0)\right]_2 = -\frac{1}{2}\right)$ the energy of the Fermi-Dirac gas field is

$$E = -kT \ln 3 + kTE_0. \quad (1.53)$$

The negativity of energy (1.53) means that there is no physical meaning for this quantity.

To get rid of the difficulties associated with the negative value of the energy field (1.53) Dirac suggested that in the normal state, i.e. in a vacuum, all positive energy electronic levels are free, and all negative energy levels are occupied. Such a state of the electron-positron field is equilibrium, since, by virtue of the Pauli principle, transitions into the state of negative energy cannot take place. Dirac suggested that electrons that are at negative levels are unobservable; the observed ones are the deviations from the state of the vacuum. Consequently, the "hole" in the vacuum can be interpreted as a positively charged electron, i.e. as a positron. From the Dirac theory it follows that the observed energy field (the density of the Lagrangian of the Fermi-Dirac gas) is positive and equal to the sum of the energy fields produced by electrons and positrons.

Fermions particles having positive energies can totality create both positive and negative energy fields [2] (p. 82). The point is that, if we assume that the positive energy field created by the fermions is on the Riemannian surface, then the negative energy field created by them is located on the pseudo-Riemannian surface, i.e., on the reverse side of the Riemannian surface. Thus, the record (1.53) is valid. Consequently, Dirac's theory has lost its significance.

§ 1.4. Consideration of the Maxwell equations on the mesoscopic level

Between the microlevel and the macrolevel there is the mesolevel. This representation of the levels of matter is conditional, though, useful. The most striking example for considering the matter at the meso-level is the Brownian motion. The Schrödinger stationary equation (1.1) is also valid for the meso-level.

The Maxwell equations, like the Euler-Lagrange equation, have an important property of invariance under coordinate transformations [8]. It is necessary to note the essential difference between the Euler-Lagrange equation and the Maxwell equations. Euler-Lagrange equation was obtained from pure mathematical (variational) considerations, while Maxwell's equations are derived from physical characteristics. If we consider Maxwell's equations at the meso-level, then it becomes possible to use optimization methods.

The electromagnetic field vectors characterizing the light wave are described by Maxwell's equations (see, for example, [9]):

$$\nabla \times \mathbf{E} = -\frac{1}{c} \frac{\partial \mathbf{B}}{\partial t}, \quad (1.54a)$$

$$\nabla \times \mathbf{B} = \frac{4\pi}{c} \mathbf{j} + \frac{1}{c} \frac{\partial \mathbf{D}}{\partial t}, \quad (1.54b)$$

$$\nabla \cdot \mathbf{E} = 4\pi\rho, \quad (1.54c)$$

$$\nabla \cdot \mathbf{B} = 0, \quad (1.54d)$$

where $\mathbf{D} = \mathbf{E} + 4\pi\mathbf{P}$, \mathbf{P} is the polarization of the medium.

Since below we will talk about the propagation of a light wave in a spatially homogeneous, electrically neutral medium, we can assume $\rho = j = 0$. In this case, the only source of the light wave in the medium is the polarization term P . Polarization arises from the deviation of the atom shape from ideal spherical symmetry, and the deviation itself is a consequence of appearance of the electromagnetic field of a light wave in the medium. It is this interaction of the light wave with the medium that introduces nonlinearity into the problem. A light wave satisfies the wave equation, which can be obtained by taking the rotor from (1.54a) and using (1.54b). As a result, we have

$$\nabla^2 \mathbf{E} - \frac{1}{c^2} \frac{\partial^2 \mathbf{E}}{\partial t^2} = \frac{4\pi}{c^2} \frac{\partial^2 \mathbf{P}}{\partial t^2}. \quad (1.55)$$

Since \mathbf{P} depends on \mathbf{E} equation (1.55) turns out to be nonlinear. Nonlinearity is conditioned by the fact that the relaxation phenomena (collisions, spontaneous emission) do not have time to destroy the phase memory of the system, as a result of which the polarization of the medium becomes a nonlinear function of the amplitude and phase of the propagating electromagnetic pulse.

Since the duration of the light pulse varies from nanoseconds (10^{-9} s) to picoseconds (10^{-12} s), and the duration of the light cycle is femtoseconds (10^{-15} s), even the shortest pulses contain many light cycles. Therefore, it is expedient to write down the value of the field $E(x, t)$ in the form of a rapidly oscillating traveling wave with a more slowly varying envelope. It is also considered reasonable to adopt a slow phase change in the carrier wave φ and record

$$E(x, t) = \Re(x, t) \cos[kx - \omega t + \varphi(x, t)]. \quad (1.56)$$

A slow change in both length \mathfrak{R} and φ time scales means the fulfillment of the following strengthened inequalities

$$\frac{\partial \mathfrak{R}}{\partial x} \ll k \mathfrak{R}, \quad \frac{\partial \mathfrak{R}}{\partial t} \ll \omega \mathfrak{R}, \quad (1.57)$$

$$\frac{\partial \varphi}{\partial x} \ll k, \quad \frac{\partial \varphi}{\partial t} \ll \omega. \quad (1.58)$$

Thus, the fulfillment of the expression (1.56) and the conditions (1.57) and (1.58) allows us to consider the Maxwell equations at the mesoscopic level. In what follows we will need the below-defined parameters of atomic physics, which occur in the next two sections.

Below we shall consider an idealized medium consisting of atoms having only two energy levels. It is assumed that the energy difference between the upper level a and the lower level b is approximately proportional to the frequency of the incident light $\omega_0 = 2\pi\nu_0$. Consequently, it is assumed that the resonance condition $E_a - E_b \equiv \hbar\omega_{ab} \approx \hbar\omega_0$ is satisfied, where \hbar is the Planck constant divided by 2π .

We will use the concept of the initial polarization of an atom

$$p_0 \equiv -e \int \psi_a^* r \psi_b d\tau = -e \int \psi_b^* r \psi_a d\tau,$$

where

e is the electron charge;

ψ_a – the wave function of the Schrödinger equation, corresponding to the level a ;

ψ_a^* – the self-adjoint wave function of the Schrödinger equation, corresponding to the level a ,

r – the internal atomic coordinate.

Since the atoms are distributed depending on the velocity, i.e. according to the velocities, then there is a corresponding distribution over the frequency shifts $\nabla\omega$. Generally, the distribution of the frequency shifts is given by the function $g(\nabla\omega)$. The function $g(\nabla\omega)$ is often assumed to be Gaussian.

Modeling the process of propagation of ultra-short pulses in a two-level resonant medium is given by Maxwell's equations (1.54) for describing the electromagnetic pulse, as well as a binary (two-level) ensemble of energy levels of atoms to describe the medium in which the impulse moves.

§1.5. The optimality of the stationary atom model

We introduce the dependent variable

$$\tilde{\mathfrak{R}} = p_0 \mathfrak{R} / \hbar ,$$

which has a frequency dimension.

We define it as follows

$$\tilde{\mathfrak{R}} = \frac{\partial \sigma}{\partial t} .$$

From the last denotation we have

$$\sigma(x, t) = \int_{-\infty}^t \tilde{\mathfrak{R}}(x, t') dt' ,$$

and $\sigma(x, -\infty) = 0$. This case refers to the state of the system before the arrival of the pulse.

Next, we introduce the coordinate transformation [9]:

$$\xi = \Omega x / c, \quad \tau = \Omega(t - x / c), \quad (1.59)$$

where $\Omega^2 = \frac{2\pi n_0 \omega_0 p_0^2}{\hbar}$,

n_0 – the number of atoms per unit volume;

x – is the coordinate of the atom;

c – speed of light.

Denotation (1.59) leads to the following operators

$$\frac{\partial}{\partial t} = \Omega \frac{\partial}{\partial \tau}, \quad \frac{\partial}{\partial x} = \frac{\Omega}{c} \left(\frac{\partial}{\partial \xi} - \frac{\partial}{\partial \tau} \right). \quad (1.60)$$

If we use operators (1.60) in relation to the defining equation

$$\frac{\partial \tilde{\mathfrak{R}}}{\partial t} + c \frac{\partial \tilde{\mathfrak{R}}}{\partial x} = \pm \Omega^2 \sin \sigma , \quad (1.61)$$

then equation (1.61) takes the form of the sine-Gordon equation

$$\frac{\partial^2 \sigma}{\partial \xi \partial \tau} = \pm \sin \sigma , \quad (1.61a)$$

where the bottom sign refers to the amplifier, and the upper sign to the attenuator, if

$$\sigma(x, -\infty) = 0 .$$

In Supplement A it is shown that the sine-Gordon equation(1.61a) is optimal. ***The atom is in a stationary state on the separatrix of a mathematical pendulum, i.e. it is at some point of***

the optimal trajectory. It depends on the coordinate of the atom, whether exactly at which point of the separatrix the atom is.

§ 1.6. The optimality model of moving atoms

A well-known result of the theory of solitons in atomic physics – the area theorem shows how the propagation of a light pulse in attenuators and amplifiers affects the total area under the impulse, determined by the expression

$$\Theta(x) = \frac{p_0}{\hbar} \int_{-\infty}^{\infty} \mathfrak{R}(x, t) dt. \quad (1.62)$$

After some simple but long transformations [9] of (1.62), we can have equation

$$\frac{d\Theta}{dx} = \pm \frac{\alpha}{2} \cos \Theta \quad (\text{compare with A.6}). \quad (1.63)$$

The sign "+" refers to the amplifier, and the sign "-" to the attenuator, $\alpha = \frac{4\pi^2 n_0 \omega_0 p_0^2 g(0)}{\hbar c}$.

An intermediate solution of equation (1.63) satisfying condition $\Theta = \Theta_0$ for $x = x_0$, will be written as follows:

$$\text{tg} \left| \frac{\Theta_s}{2} + \frac{\pi}{4} \right| = \text{tg} \left(\frac{\Theta_0}{2} \right) e^{\pm \frac{\alpha}{2}(x-x_0)}.$$

From the last expression, we find the required area as a function of the coordinate of the atom x and the initial conditions Θ_0 and x_0 :

$$\Theta_{s\pm} = \pm 2 \arctg \left\{ \text{tg} \left(\frac{\Theta_0}{2} \right) \exp \left[\pm \frac{\alpha}{2}(x-x_0) \right] \right\} \mp \frac{\pi}{2}. \quad (1.64)$$

We introduce the notations $\Theta_s = \varphi_s / 2$, $x = t$, $\pm \omega_0 = \pm \alpha / 2$, then equation (1.63) becomes equivalent to equation (A.6); this means that the relation (1.64) (for initial conditions $\Theta_0 = 90^\circ$ when $x_0 = 0$) determines the angle of rotation of the separatrix as a function of the coordinate of the atom x :

$$\Theta_{s+} = 4 \arctg(e^{\omega_0 x}) - \pi \quad (1.65a)$$

and

$$\Theta_{s-} = -4 \arctg(e^{-\omega_0 x}) + \pi. \quad (1.65b)$$

Formulas (1.65a) and (1.65b) are identical to formulas (A.8) (Supplement A). Since in the relation (1.64) the initial condition Θ_0 is other than 90° ($\Theta_0 \neq 90^\circ$ for $x_0 \neq 0$), then formula

(1.64) also determines the angle of rotation of the separatrix of a mathematical pendulum as a function of the coordinate of the atom and the initial conditions Θ_0 and x_0 :

$$\Theta_{s+} = 2\text{arctg} \left\{ \text{tg} \left(\frac{\Theta_0}{2} \right) \exp \left[+ \frac{\alpha}{2} (x - x_0) \right] \right\} - \frac{\pi}{2} \quad (1.66a)$$

and

$$\Theta_{s-} = -2\text{arctg} \left\{ \text{tg} \left(\frac{\Theta_0}{2} \right) \exp \left[- \frac{\alpha}{2} (x - x_0) \right] \right\} + \frac{\pi}{2}. \quad (1.66b)$$

Formulas (1.66a) and (1.66b) show that the motion of atoms occurs along the trajectory of the separatrix, i.e. on the optimal trajectory. The value $\alpha(\omega_0)$ is called the absorption coefficient of a weak monochromatic field of frequency ω_0 .

Since expressions (1.66) satisfy Hamilton's equations (A.3), the optimality of the model of moving atoms is obvious. This conclusion can be arrived at by comparing equations (1.63) and (A.6), from which it is clear that they are structurally identical and, consequently, equation (1.63) has the same optimal property as equation (A.6).

The propagation of an ultra-short pulse in a two-level resonant medium under the action of the leading edge of the pulse causes the transition of atoms of the lower energy state E_b to the upper energy state E_a ; as a result of this transition, the medium becomes completely inverted. Under the action of the remainder of the pulse, the atoms that have passed to the upper energy state begin to radiate in an induced manner. This phenomenon was called "self-induced transparency." When the phenomenon of "self-induced transparency" appears, the energy transferred to the quantum system is inversely to taken away, there by restoring the original form of the pulse. In the dictionary of synergetics, it sounds as "self-organizing transparency". From the mathematical point of view, this phenomenon is caused by the fact that the "reversal" operator is used (see Supplement A) for obtaining expressions (1.66). As a result of using the "reversal" operator, the system (1.66) becomes closed, i.e. self-organizing.

§1.7. Modern interpretation of the General Theory of Relativity (GTR) [10]

The creation of GTR was preceded by a special theory of relativity (STR). Created in order to solve the problems of electrodynamics, STR also contained unresolved problems of GTR for example, a differential equation that establishes a connection between energy and mass m moving with the velocity c commensurate with the speed of light, given by

$$\frac{dE}{dt} = \frac{d}{dt} (mc^2), \quad (1.67)$$

is the link between the problems of STR and GTR.

To solve the relativity problems, A. Einstein formulated GTR. In equation (1.67), the mass m is determined by using the Lorentz transformation

$$m = \frac{m_0}{\sqrt{1 - \left(\frac{v}{c}\right)^2}}, \quad (1.68)$$

where m_0 is the initial mass, found for $v = 0$.

For GTR Einstein used tensor calculus. In our opinion, the tensor calculus has two significant drawbacks: 1. It reduces the solution of the problem to an open form, when it is necessary to determine the infinite number of tensor components for its exact solution; 2. The tensor calculus has no physical interpretation. These shortcomings adversely affect the solution of problems using tensor calculus. This monograph proposes a new approach to creation of GTR, free from these shortcomings.

It should be noted that K. Schwarzschild [11] found the exact solution of problem of GTR for a static mass possessing spherical symmetry, i.e. for a particular case, without the use of an infinite number of tensor components.

Fig. 3 shows the flowcharts of sequences of mathematical operations for solving the problem of GTR, proposed by Einstein (Fig. 3a) and by the author (Fig. 3b).

The sequence of mathematical operations of Einstein

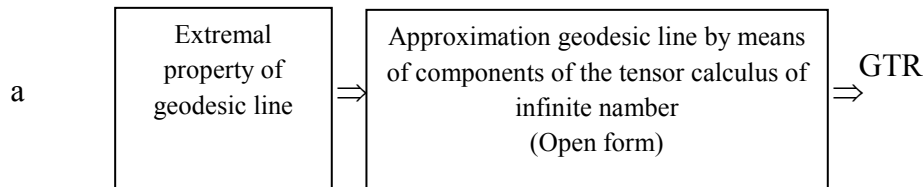

The sequence of mathematical operations of the author

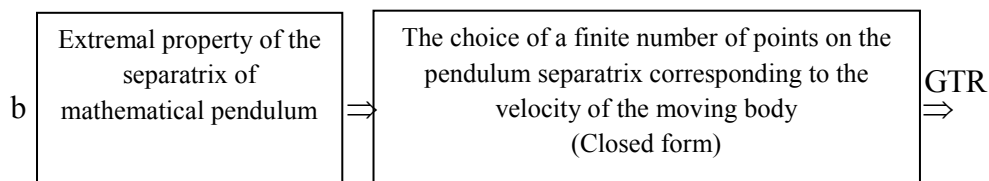

Fig. 3

To illustrate the author's method, it is advisable to consider the functioning of a mathematical pendulum in terrestrial conditions. The phase trajectories of the motion of the mathematical pendulum, depending on the various values of the total energy (see A.2), are shown in Fig. 4. Fig. 4a shows different levels of total energy at which the pendulum functions, and Fig. 4b gives corresponding phase portrait of these trajectories. In Fig. 4b we have the following notations:

Number 3 – the pendulum separatrix has the breadthless length; it does not represent a set (Supplement B, case 2b),

Number 2 – corresponds to the oscillatory motion of the pendulum; it is edged with the set 2 and itself belongs to this set (Supplement B, case 1),

Number 1 – corresponds to the pendulum's swinging motion; it belongs to a set that extends from contour 1 to separatrix 3. Separatrix 3 does not belong to set 1 (Supplement B, case 2a).

To create GTR, Einstein used the extreme property of a geodesic line. Variational methods make it possible to replace the equation of the geodesic line by the Euler-Lagrange equation.¹ As noted in the introduction (see also (0.8a) and (0.8b)), the Euler-Lagrange equation is equivalent to the Hamilton equation. Consequently, according to Hamilton's equation (the first equation (A.3)), the pendulum separatrix has an extremal (optimal) property. We use the extremal property of the separatrix of a mathematical pendulum to create GTR instead of the extreme property of a geodesic line.

Let's consider the practical implementation of the author's algorithm according to the block diagram in Fig. 3b. Let us turn to the segment of the separatrix ABC, shown in Fig. 4b, which corresponds to the formula (A.8d).

¹Lagalli M. Vector calculus. Moscow, 1936

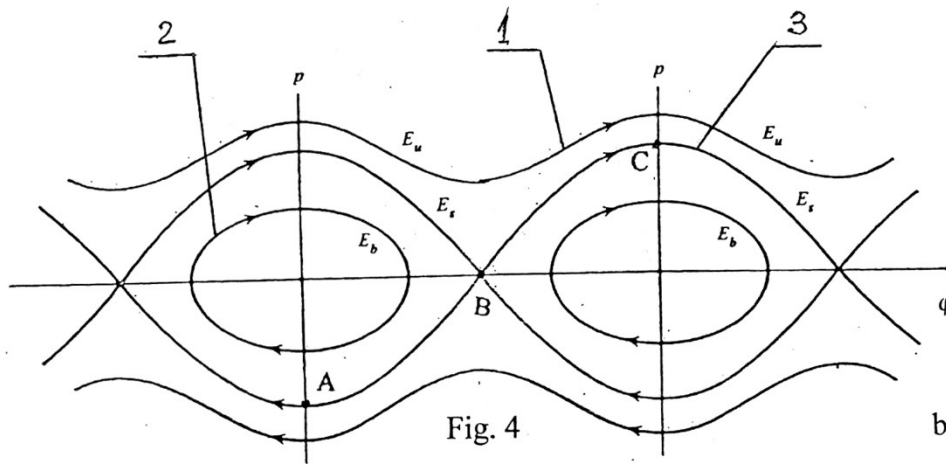
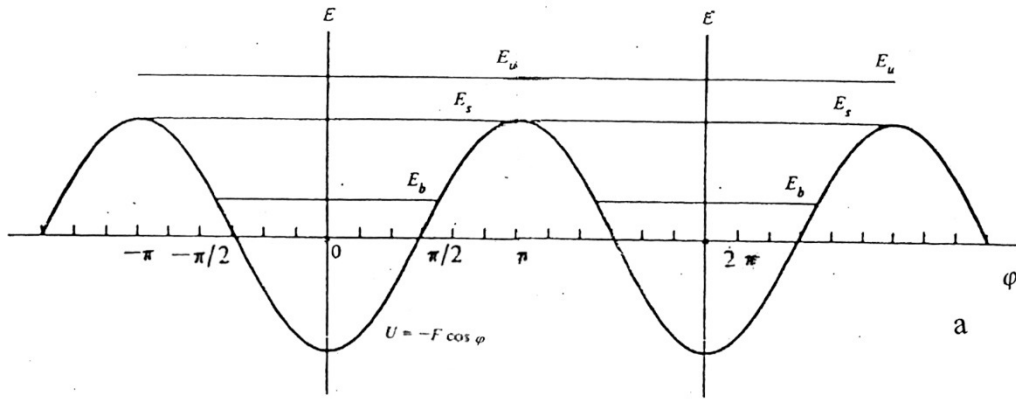

Fig. 4

On the interval $[0, \pi]$ the separatrix segment ABC is characterized by a concave, descending branch of the BA, i.e. by some line of a pseudo-Riemannian surface; it is defined by the formula (A.8b) with account of sign "-":

$$\varphi_{S-} = -4\text{arctg}[\exp(-\omega_0 t)], \quad (1.69)$$

without taking into consideration term π .

On the interval $[\pi, 2\pi]$ the separatrix segment ABC is a convex ascending branch of BC, i.e. a certain line of the Riemannian surface; it is defined by the formula (A.8a) with account of sign "+":

$$\varphi_{S+} = 4\text{arctg}[\exp(\omega_0 t)], \quad (1.70)$$

without taking into consideration the term π .

Consequently, instead of formulas (1.69) and (1.70), the separatrix ABC can be described by a single formula

$$\varphi_S \equiv \varphi_{SABC} = \begin{cases} |-4\text{arctg}[\exp(-\omega_0 t)]|, & \text{for } \omega_0 t \in [0, \pi] \\ 4\text{arctg}[\exp(\omega_0 t)], & \text{for } \omega_0 t \in [\pi, 2\pi] \end{cases} \quad (1.71)$$

The separatrix segment ABC is shown separately in Fig. 5.

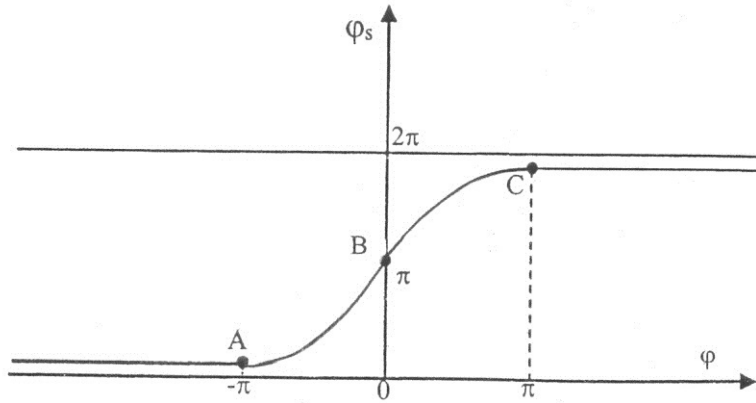

Fig. 5

Now, let us find the asymptotes of the separatrix segment ABC (Fig. 5). The solution of the lower equation (1.71) for $\omega_0 t = \varphi_s$ allows us to determine the upper asymptote $\varphi_{S_{\max}} = 6.275659\dots$. We used a personal computer to solve the transcendental equation (1.71) in an iterative way. Saturation of six digits after the decimal began after six iteration steps, starting with the first step equal to one. Since the curve ABC is symmetric about the axis $O\varphi_s$, the lower asymptote is determined by the difference $\varphi_{S_{\min}} = 2\pi - \varphi_{S_{\max}} = 0.006525\dots$

To determine the body mass m moving with a velocity v commensurate with the speed of light c , it is necessary to use formula (1.68). For this purpose, the values of the ABC curve should be displayed on the hyperbolic tangent function, i.e. for a fixed point $\varphi_{S,i}$ of the curve ABC, you need to find the corresponding value of the function $\text{th}(\varphi_{S,i}) = v_i/c$. Consequently, the velocity of the body at a point i will be defined from relation

$$v_i = c \left\{ \text{th} \left[4 \text{arctg} \left(e^{\varphi_i} \right) \right] \right\}, \quad -\pi \leq \varphi_i \leq \pi, \quad (1.72)$$

whose mass at the point i is in expression (1.68)

$$m_i = m_0 \text{ch} \left[4 \text{arctg} \left(e^{\varphi_i} \right) \right], \quad -\pi \leq \varphi_i \leq \pi. \quad (1.73)$$

The use of formulas (1.72) and (1.73) is illustrated in five examples.

1. Assume $\varphi = -2$, where $\varphi_{S,-2} = 4 \text{arctg} \left(e^{-2} \right) = 0.538072$. Speed of the body will be $v = c \left[\text{th} \left(0.538072 \right) \right]$, and the body weight will be equal to $m = m_0 \text{ch} \left(0.538072 \right)$.

2. Assume $\varphi = -1$, where $\varphi_{S,-1} = 4 \text{arctg} \left(e^{-1} \right) = 1.410054$. Speed of the body will be $v = c \left[\text{th} \left(1.410054 \right) \right]$, and the body weight will be equal to $m = m_0 \text{ch} \left(1.410054 \right)$.

3. If $\varphi = 0$, then we will have: $\varphi_{s,0} = 4\text{arctg}(e^0) = \pi = 3.141592$. In such a case speed of the body is equal to $v = c[\text{th}(3.141592)]$, and the body weight will be: $m = m_0\text{ch}(3.141592)$.

4. If $\varphi = 1$, we have $\varphi_{s,1} = 4\text{arctg}(e^1) = 4.873132$. The speed of the body $v = c[\text{th}(4.873132)]$, and the corresponding body weight is equal to $m = m_0\text{ch}(4.873132)$.

5. If we assume that $\varphi = 2$, then we will have: $\varphi_{s,2} = 4\text{arctg}(e^2) = 5.745113$, speed of the body will be $v = c[\text{th}(5.745113)]$, and the body weight will be: $m = m_0\text{ch}(5.745113)$.

Thus, it follows from the Lorentz transformations that the state (i.e., the value) of a physical quantity (in this case mass) depends on its speed, if this speed is commensurable with the speed of light. For an arbitrary physical quantity (length, time, etc.), the above can be generalized by using these hyperbolic functions.

Let us find the length ℓ_i of a certain body moving with the velocity v_i corresponding to point i of the function ABC (see Fig. 5), and commensurable to the speed of light c . The velocity of this body, expressed in terms of the speed of light, is found from formula (1.72). The length of a given body, determined with the use of the Lorentz transformation, is reduced in accordance with expression

$$\ell_i = L \text{sech}\left[4\text{arctg}(e^{\varphi_i})\right] < L, \quad -\pi \leq \varphi_i \leq \pi,$$

where L is the length of the body at rest, i.e. when $v = 0$.

In the case when the system moves at a speed corresponding to the first point of the ABC function (see Fig. 5), not only does the length of this system (body) decrease, but the time flow τ_i also slows down according to formula

$$\tau_i = t \text{sech}\left[4\text{arctg}(e^{\varphi_i})\right] < t, \quad -\pi \leq \varphi_i \leq \pi,$$

where t is the time flow in a stationary system ($v = 0$).

Consequently, the use of the above technique for determining the changes in physical quantities (mass increase, shortening and slowing down of the timeflow) of a system moving with a speed commensurate with the speed of light gives the same results as GTR.

Two different approaches to the solution of one problem lead to two different algorithms of its solution. However, it should be noted that the starting point in both approaches is the optimality of the problem posed: in one case, the basis of the solution is the Euler-Lagrange optimization equation, and in the other, the equivalent Hamiltonian equation.

It is possible to compare these two approaches in the case of an exact solution of the stated problem, i.e. for the Schwarzschild problem.

For a spherical coordinate system

$$x = r \sin \theta \cos \psi, \quad y = r \sin \theta \sin \psi, \quad z = r \cos \theta, \quad (1.74)$$

Near a static mass with spherical symmetry, for a Riemannian interval ds^2 there is an exact solution

$$ds^2 = -\frac{dr^2}{1-\frac{a}{r}} - r^2 (d\theta^2 + \sin^2 \theta d\psi^2) + \left(1 - \frac{a}{r}\right) c^2 dt^2, \quad (1.75)$$

where $a = \frac{2\alpha m}{c^2}$, α – gravitational constant of Newton, m – mass of a body with spherical symmetry.

It should be noted that the coordinate system (1.74) is an orthogonal curvilinear system. In the gravitational field of this body, the trajectories of the uncharged particle are the geodesic lines of the Riemannian space satisfy an equation

$$\frac{d^2 y^\rho}{ds^2} + \left\{ \begin{matrix} \rho \\ \mu, \nu \end{matrix} \right\} \frac{dy^\mu}{ds} \frac{dy^\nu}{ds} = 0, \quad (1.76)$$

where $\left\{ \begin{matrix} \rho \\ \mu, \nu \end{matrix} \right\}$ is the Christoffel symbol.

Symbol $\left\{ \begin{matrix} \rho \\ \mu, \nu \end{matrix} \right\}$ is replaced by its values calculated using potentials

$$g_{00} = -\frac{1}{g_{11}} = \left(1 - \frac{a}{r}\right), \quad g_{22} = \frac{g_{33}}{\sin^2 \theta} = -r^2.$$

We write the equation of the geodesic line (1.76) first for $\rho = 2$. Assuming $y^1 = r$, $y^2 = \theta$, $y^3 = \psi$ we obtain

$$\frac{d^2 \theta}{ds^2} + \frac{2}{r} \frac{dr}{ds} \frac{d\theta}{ds} - \cos \theta \sin \theta \left(\frac{d\psi}{ds} \right)^2 = 0.$$

We choose the coordinate system (1.74) so that the motion of the particle occurs on the plane xoy , i.e. when $z = 0$. This is achieved when $\theta = \pi/2$. In such a case

($d^2 \theta = 0$) equation (1.75) will be written as follows

$$ds^2 = -\frac{1}{\alpha} dr^2 - r^2 d\psi^2 + \alpha c^2 dt^2, \quad (1.77)$$

where $\alpha = 1 - \frac{2\alpha m}{c^2 r} = 1 - \frac{a}{r}$

Equation (1.76) for $\rho = 3$ and $\rho = 0$ will be written as follows

$$\frac{d^2\psi}{ds^2} + \frac{2}{r} \frac{d\psi}{ds} \frac{dr}{ds} = 0,$$

$$\frac{d^2t}{ds^2} + \frac{\alpha_r'}{\alpha} \frac{dr}{ds} \frac{dt}{ds} = 0.$$

Integration of the last two equation will give

$$r^2 \frac{d\psi}{ds} = \frac{h}{c} \equiv \frac{1}{\sqrt{b}}, \quad \frac{dt}{ds} = \frac{k}{\alpha c^2}, \quad (1.78)$$

where h and k are the constants of integration.

If we now integrate (1.76) for $\rho = 1$, excluding from it dt and ds with the help of (1.78), we will have

$$\frac{1}{\alpha} \left(\frac{h}{r^2 c} \frac{dr}{d\psi} \right)^2 + \frac{h^2}{r^2 c^2} - \frac{k^2}{\alpha c^2} = -1. \quad (1.79)$$

We introduce notation

$$u = \frac{1}{r}. \quad (1.80)$$

With account of notation (1.80), expression (1.79) can be written as follows

$$\left(\frac{du}{d\psi} \right)^2 = \frac{2\alpha m}{c^2} u^3 - u^2 + \frac{2\alpha m}{h^2} u - \frac{c^2}{h^2} \left(1 - \frac{k^2 h^2}{c^4} \right). \quad (1.81)$$

The solution of the Schwarzschild problem (1.81) cannot be compared with the author's method. The impossibility of such a comparison is due to the fact that the solution (1.81) uses the rotation angle ψ of the spherical coordinate system (1.74) as the distance argument $u = 1/r$ up to a spherically symmetric mass, while the author's method is based on the formula (1.71), in which the angle of rotation of the separatrix φ_s depends on the current time or the corresponding angle specified in radians. However, since the Hamilton equations are equivalent to the Euler-Lagrange equations (see(0.8a) and (0.8b)), it is possible to compare the exact solution (1.81) if the Schwarzschild problem is solved using the Euler-Lagrange equation, which is equivalent to the author's solution. Therefore, we turn to the solution of the Schwarzschild problem with the application of Euler-Lagrange equation.

The Lagrange function L is defined only as the sum of the kinetic energies of the corresponding terms of the Riemannian interval (1.77):

$$L = -\frac{1}{2} \frac{r_s^2}{1 - \frac{a}{r}} - \frac{1}{2} r^2 \psi_s^2 + \frac{1}{2} c^2 \left(1 - \frac{a}{r} \right) t_s^2. \quad (1.82)$$

The Euler-Lagrange equations¹ can be written in the form

$$\frac{d}{ds} \left(\frac{\partial L}{\partial \psi_s} \right) - \frac{\partial L}{\partial \psi} = 0, \quad (1.83)$$

$$\frac{d}{ds} \left(\frac{\partial L}{\partial t_s} \right) - \frac{\partial L}{\partial t} = 0, \quad (1.84)$$

$$\frac{d}{ds} \left(\frac{\partial L}{\partial r_s} \right) - \frac{\partial L}{\partial r} = 0, \quad (1.85)$$

where the index s for variables ψ , t , r denote the derivative of s . From the solution of equations (1.83) and (1.84) it follows that $\frac{\partial L}{\partial \psi_s} = \text{const.}$ and $\frac{\partial L}{\partial t_s} = \text{const.}$, i. e. we have

$$r^2 \frac{d\psi}{ds} = \frac{1}{\sqrt{b}}, \quad (1.86)$$

$$\left(1 - \frac{a}{r} \right) \frac{dt}{ds} = - \frac{k^2}{c^2 \sqrt{b}}, \quad (1.87)$$

where $b \equiv \frac{c^2}{h^2}$ – is constant.

With account of equations (1.86) and (1.87) in equation (1.77), we will have

$$\frac{dr^2}{1 - \frac{a}{r}} = \left[-br^2 + \frac{k^2 r^2}{c^2 \left(1 - \frac{a}{r} \right)} - 1 \right] r^2 d\psi^2. \quad (1.88)$$

Taking into consideration the notation (1.80) of equation (1.88) we obtain

$$\left(\frac{du}{d\psi} \right)^2 = au^3 - u^2 + abu + \frac{k^2}{c^2} - b. \quad (1.89)$$

If in (1.89) we substitute the above notations $a = 2\alpha m / c^2$ and $b = c^2 / h^2$, then the equation (1.89) will coincide with equation (1.81). This proves that the application of the author's method is equivalent to the application of the Einstein method for solution of the Schwarzschild problem.

By solving equation (1.85), one can verify the validity of the Euler-Lagrange equation.

¹Equations (1.83) – (1.85) are called Euler-Lagrange equations, because the interval ds is proportional to the interval of time dt , i.e. $ds = vdt$, where v is the speed of a moving body.

In the monograph [12] (§14), there was expressed an idea that in the case of geometrodynamics, the dynamic object is not a space-time, i.e. it is three-dimensional space and not four-dimensional.

The space dimension is not an objective reality, and depends on the coordinate system the researcher chooses. If there is no need to consider the relativistic effect (for example, in geometrodynamics), then it is necessary to use a coordinate system that does not explicitly show time, but describes a three-dimensional space changing in time.

If it is necessary to consider the relativistic effect, then according to equation (1.81), we should choose the orthogonal curvilinear coordinate system (1.74). This can be illustrated by the example of the Schwarzschild problem.

The trajectory of motion of the planet Mercury can be obtained if the equation (1.81) is differentiated by u :

$$\frac{d^2u}{d\psi^2} + u = \frac{3\alpha m}{c^2} u^2 + \frac{\alpha m}{h^2}. \quad (1.90)$$

It is not difficult to show [13] that in this case, equation (1.90) leads to the precession of the major axis of the elliptical trajectory along which the planet moves; this precession in a

$$\text{century is } \Omega = \frac{20946.357 \cdot 10^{12}}{\Delta(1-\varepsilon^2)T} = 42,9 \text{ angular seconds,}$$

where $\Delta = 5,8 \cdot 10^{12} \text{ cm}$ is the major axis of trajectory,
 $\varepsilon = 0.2056$ is the eccentricity of trajectory,

$T = 87.97$ days – the period of revolution of the planet in the star days.

It will take three million years for the major axis of the ellipse, along which Mercury moves, to make a complete revolution around the Sun.

We now turn to the solution of this problem in the case of a coordinate system using the Weierstrass elliptic function \wp . Introduce notation

$$u = \frac{4}{a}U + \frac{1}{3a}. \quad (1.91)$$

With account of notation (1.91), equation (1.89) can be written in the form

$$\left(\frac{dU}{d\psi} \right)^2 = 4U^3 - g_2U - g_3, \quad (1.92)$$

$$\text{where } g_2 = \frac{1}{12} - \frac{a^2b}{4}, \quad g_3 = \frac{1}{216} + \frac{a^2b}{24} - \frac{a^2k^2}{16c^2}.$$

The integration of equation (1.92) gives $U = \wp(\psi + C)$,
 where C is the constant of integration.

Taking the last expression into consideration, the substitution of (1.91) will be written as follows

$$u = \frac{1}{r} \equiv \frac{1}{3a} + \frac{4}{a} \wp(\psi + C). \quad (1.93)$$

Consequently, substitution of (1.91) allows us to change equation (1.89) into equation (1.92), with its subsequent solution by the Weierstrass elliptic function.

We now define the trajectory of the planet in the coordinate system (U, ψ) . To this end, we differentiate equation (1.92) in terms of U :

$$\frac{d^2U}{d\psi^2} - 6U^2 = -\frac{1}{2}g_2. \quad (1.94)$$

Expression (1.94) is the equation of an unstable oscillator; ***the coefficient of the variable U^2 does not contain the speed of light c . This circumstance explains the fact that a body moving according to (1.94) does not have a relativistic effect.*** It is also necessary to pay attention to one of the coefficients of the equation of the planet Mercury trajectory (1.90), which contains the speed of light c : this is the coefficient $3\alpha m/c^2$ for the variable u^2 . ***According to the dependence of the coefficient of the desired variable u on c , there will be a relativistic effect.***

Thus, the choice of this or that coordinate system imposes a restriction on the physical meaning of the problem. The results of GTR are used: in Microworld for elementary particles moving with the velocities commensurate with the speed of light, in the Macroworld for spacecraft flight, in Megaworld for moving the Galaxies, stars and planets.

CHAPTER 2

New models of Megaworld and their optimality

*To someone who grasp the Universe from a unified standpoint,
the entire creation would appear as a unique truth and necessity*

J. d'Alembert

Cosmology came to the conclusion that the mass of matter in the Universe, possessing the appropriate gravity, is capable to stop the expansion of the Universe. The current expansion of the Universe is modeled by an imaginary sphere, on the surface of which there are particles - Galaxies. After the expansion of the Universe, its compression will take place; the whole process of expansion and compression is of a pulsating nature, adequately described by the equations of a mathematical pendulum. Expansion of the Universe is a stable process, and its compression is an instable process. At a constant rate of change in the radius (an imaginary inflation or compression) of the sphere, the whole process of expansion and compression, as shown in §2.3, is simulated by the equations of closeness and super-closeness. These equations are the consequence of the joint solution of the instable and stable systems of Lotka-Volterra equations. As a result of solving the equations of closeness and super-closeness, the radius of an imaginary sphere an expanding and compressing is determined. The inverse value of this radius serves as the curvature of the Universe (see §2.4, point 6). Consequently, the curvature of the Universe can be defined not by the solution of classical equations of the gravitational field [14], but as the inverse values of the radius of the spheres corresponding to the expansion and compression of the Universe. This method of determining the curvature of the Universe follows from the approach to modeling the evolution of the Universe proposed by us.

§2.1. Possible model of the formation of dark matter in the Universe

In recent years, a very important discovery was made: it became known that the mass of luminous objects in the Universe is about four percent of the total mass of the matter existing in the Cosmos. The rest of the mass (about 96%) falls on a dark (unclear) matter. This means that the average density of matter in the Universe is $\rho = 10^{-12} \text{ g / cm}^3$ that many times exceeds its critical density $\rho_c = 10^{-29} \text{ g / cm}^3$. It follows from the above said that the total mass of matter in the Universe is such that it is able to stop its expansion [15], i.e. the Universe is closed. The

expansion of the Universe, which began at the time of "creation of the World", is followed by the process of its compression, and the compression is followed by expansion and so on. Consequently, the Universe is characterized by a cyclic evolution.

The fact that the space curved by gravity initiates the formation of matter is well known. However, the mechanism of formation of the matter in a curved space was never considered. The environment in which the mechanism of the matter formation proposed by us can act is an elastic model of the physical vacuum, and the elementary particle acts as a singularity in this medium. Consequently, in this model the physical vacuum is an elastic solid, and the particle is regarded as a localized agent of this body. It should be noted that such a model of the physical vacuum is not something new. In the book [16] a similar model is given in an elementary but informative presentation. The problem of the formation of matter in a vacuum is considered in [17], and the elastic model of vacuum is devoted to the work [18].

The displacement equation for changing the state of an elastic medium in the linear approximation is given in the monograph [19]; in vector form it has the form

$$\rho \frac{\partial^2 \mathbf{u}}{\partial t^2} + \mu \operatorname{rot} \operatorname{rot} \mathbf{u} - (\lambda + 2\mu) \nabla \operatorname{div} \mathbf{u} = \mathbf{X}, \quad (2.1)$$

where

\mathbf{u} is the particle displacement vector;

ρ – density of medium;

μ and λ are the constants of an elastic medium, called Lamé coefficients having a dimension of $\frac{\text{erg}}{\text{cm}^3}$, \mathbf{X} is the vector of external action with respect to the elastic medium. If we introduce

the notation $c_1 = \sqrt{\mu / \rho}$ and $c_2 = \sqrt{(\lambda + 2\mu) / \rho}$, then equation (2.1) can be written in the form

$$\frac{\partial^2 \mathbf{u}}{\partial t^2} + c_1^2 \operatorname{rot} \operatorname{rot} \mathbf{u} - c_2^2 \operatorname{grad} \operatorname{div} \mathbf{u} = \rho^{-1} \mathbf{X}, \quad (2.2)$$

where:

c_1 is the propagation velocity of the transverse wave,

c_2 – the velocity of propagation of a longitudinal wave in an elastic medium.

In our opinion, the increase of the volume in a space curved by gravity (vacuum), in which a dark matter is formed, is described by the stationary equation corresponding to equation (2.2). Based on these considerations, a localized microparticle of a dark matter is characterized by a

point-like inclusion defect, i.e. center of dilatation. This dilatation center is a right-hand side part of the stationary equation

$$c_1^2 \text{rot rot } \mathbf{u} - c_2^2 \text{grad div } \mathbf{u} = \mathbf{Q},$$

which is given by [20]

$$\mathbf{Q} = -\frac{b}{\rho} \text{grad } \delta(\mathbf{r} - \mathbf{r}'), \quad (2.3)$$

where

$\mathbf{Q} = \rho^{-1} \mathbf{X}$ is the reduced vector of external action with respect to the elastic medium;

$|\mathbf{b}| \equiv b$ – the Burgers vector value;

δ – the Dirac function;

\mathbf{r}' – vector of the current distance to the center of inclusion (dilatation), i.e. the center of the sphere radius r .

In the elastic medium, the reduced external action vector (2.3) causes a potential displacement field

$$\mathbf{u}(\mathbf{r}) = -\frac{b}{4\pi\rho c_2^2} \text{grad} \left[\frac{1}{|\mathbf{r} - \mathbf{r}'|} \right].$$

The divergence of this displacement is everywhere equal to zero, except for the dilatation point [20]; consequently, we have

$$\text{div } \mathbf{u} = \frac{b}{\rho c_2^2} (\mathbf{r} - \mathbf{r}'). \quad (2.4)$$

It is well known that the negative value of the Burgers vector is defined as the circulation of the differential of the displacement vector

$$\oint \mathbf{d}\mathbf{u}(\mathbf{r}) = -\mathbf{b}. \quad (2.5)$$

If the integrand of equation (2.5) for each component of the displacement vector u_k will be written in the form

$$du_k = u_{ik} dr_i, \quad (2.6)$$

(where $u_{ik} = \frac{\partial}{\partial r_i} u_k$ is the tensor of elastic distortion), then we have

$$\oint u_{ik} dr_i = -b_k, \quad (2.5a)$$

i.e., the circulation of the tensor of elastic distortion around the dilatation gives the negative component of the Burgers vector.

For the displacement component defined by expression (2.4), we have

$$u_{ik} = \frac{b_k}{\rho c_2^2} \delta(r_i - r'_i), \quad i = 1, 2, \dots \quad (2.7)$$

If we introduce the notation $u_k = \Delta V_k$, then, taking into account (2.6) and (2.7), we can assert that as a result of the displacement of the k -th particle in a vacuum curved by gravity, there is an increase in the volume ΔV_k , where a dark matter is formed; this increase in volume is determined from expression

$$\Delta V_k = \frac{b_k}{\rho c_2^2} \int \delta(r_i - r'_i) dr'_i = \frac{b_k}{\rho c_2^2}.$$

The last expression is considered as the statement of the problem of determining the volume in which a dark matter is formed.

We introduce the notion of probability density of finding a k -th particle of a volume V_k , denoting this density by $p_k(\mathbf{r}', t)$. In this case, the probability of finding the Burgers b_k vector component in the volume V_k will be equal to $b_k p_k(\mathbf{r}', t)$.

We introduce the definition that the two dilatation centers do not interact in a contact-free way¹, i.e., we have

$$\Xi(k, \ell) = -\frac{b_k b_\ell}{\rho c_2^2} \int p_k(\mathbf{r}', t) p_\ell(\mathbf{r}', t) dr' = 0, \quad \text{for } k \neq \ell.$$

Interaction occurs only with direct contact of two concentrated inclusions of an elastic medium:

$$\Xi(k, k) = -\frac{b_k^2}{2\rho c_2^2} \int p_k^2(\mathbf{r}', t) dr' \neq 0, \quad \text{for } k = \ell. \quad (2.8)$$

For the probability density function, $p_k(\mathbf{r}, t)$ the following formulas hold

$$\int p_k(\mathbf{r}, t) d\mathbf{r} = 1, \quad (2.8a)$$

$$p_k = 1/V_k. \quad (2.8b)$$

Formula (2.8) shows that the contact interaction of two dilatation centers generates the energy defined by this expression. Taking into account the inside energy of particles given by equation (2.8), by means of Gibbs thermodynamic potential [21], we can estimate the volume of the region of the curved physical vacuum that is occupied by the particle. For this problem, the Gibbs thermodynamic potential is written as follows:

$$G(k) = \Xi(k, k) - T_k H(k) + T_k H_0 + s_k V_k. \quad (2.9)$$

¹Дмитриев В.П. Стохастическая механика. М.: Высшая школа, 1990.

The terms and parameters in the potential (2.9) denote the following: $H(k) = b_k / b_k^* K_k \ln V_k$ is the entropy of an ideal gas corresponding to the equilibrium state of a fluid in volume of V_k, T_k is the temperature of the point inclusion fluid of the k -th particle, K_k the coefficient, depending on the elastic properties of the medium with of the k -th particle included [20], b_k^* – the component of the Burgers vector, corresponding to one mole¹ of a point inclusion fluid, $H_0 = const$ – the initial entropy of an ideal gas in an equilibrium state; s_k – background pressure of the point inclusion of k -th particle.

With account of these notations and formulas (2.8), (2.8a), (2.8b), the potential (2.9) can be written as follows

$$G(k) = -\frac{b_k^2}{2\rho c_2^2 V_k} - \frac{b_k}{b_k^*} K_k T_k \ln V_k + T_k H_0 + s_k V_k. \quad (2.9a)$$

In order to determine the amount of the dark matter occupied by k -th particle, it is necessary to solve the unconditional optimization equation written for the sought volume

$$\frac{\partial}{\partial V_k} G(k) = 0. \quad (2.10)$$

Substitution of the potential (2.9) into equation (2.10) leads to the square equation $s_k V_k^2 - m V_k + \mu = 0$, where

$$m = \frac{K_k T_k}{b_k^*} b_k, \quad \mu = \frac{b_k^2}{2\rho c_2^2}.$$

The solution of the last equation has the form

$$V_k = D_k b_k, \quad (2.11)$$

where

$$D_k = \Phi_k \Psi_k,$$

$$\text{and } \Phi_k = \frac{K_k T_k}{2s_k b_k^*}, \quad \Psi_k = 1 + \sqrt{1 - \frac{2b_k^{*2} s_k}{\rho c_2^2 K_k^2 T_k^2}}.$$

If there is a strong inequality $1 \gg \frac{2b_k^{*2} s_k}{\rho c_2^2 K_k^2 T_k^2}$, then in this case we will have $D_k = \frac{K_k T_k}{s_k b_k^*}$.

The total volume is defined as the infinite sum of elementary volumes (2.11)

$$V = \sum_{k=1}^{\infty} V_k.$$

The last expression can be represented as a product of a row vector \mathbf{D} , having an infinite number of components D_k on a column vector $\phi \mathbf{du}(\mathbf{r})$ (see (2.5)), which also has an infinite

¹Mole is a unit of measurement for amount of substance equaling the amount of the substance system, which contains the same number of structural elements (atoms, molecules, ions, etc.) as atoms contained in carbon ¹²C with a mass of 0.012 kg.

number of components (see (2.5a)). Given the fact that the negative volume has no physical meaning, we will have

$$V = \mathbf{D} \phi \mathbf{du}(\mathbf{r}).$$

As a result of circulation, the fluid is in a rotational state. The centrifugal force acts on different parts of the fluid in different ways: a greater centrifugal force acts on that part of the fluid that contains structural elements (atoms, molecules, etc.) of a greater mass. Consequently, as a result of the circulation of the fluid, the volume is unevenly filled with this substance. In rotation, condensation of the fluid takes place, which turns into a solid body. This explains why the body formed from the solidified fluid does not have an ellipsoidal (round) shape: it has different configurations in different directions. As a result of the rotation of the dark matter around the axis passing through the center of mass (like the center of gravity) of the body, the individual points of the configuration of the dark matter rotate with the same angular velocity ω . In this case, it is possible to determine the rotational power of the dark matter around this axis:

$$W = M\omega,$$

where M is the mass of a dark matter equal to $M = \rho^*V$ and ρ^* is the density of the dark matter.

Power W can be taken as the main dynamic characteristic of a dark matter.

The obtained results show how the gravitational energy causing the curvature of space turns into real matter.

In view of the small value of the Newtonian constant of gravitation ($\alpha = 6.67 \cdot 10^{-8} \text{ cm}^3 / \text{g} \cdot \text{sec}^2$), in the above-described stage of dark matter formation, there is no gravitational phenomenon. However, after the mass of a dark matter reaches certain magnitude, the gravitational effect begins to act.

In the subsequent stages of formation of the dark matter, due to the appearance of gravitational forces, the dark matter can accept both macroscopic and megascopic dimensions commensurate with the objects of the Cosmos space.

The results of this section allow us to explain the rotation of the planet Uranus around its axis. This rotation has the opposite direction to all other planets of the solar system: in rotation of the Sun around the center of the Galaxy, the gravitational field of the Sun captured the dark matter rotating around its axis. This dark matter was called the planet Uranus.

Asteroids should be viewed not as fragments, as failed planets, but as fragments of the dark matter.

Finally, the origin of Phobos and Deimos the moons of the planet Mars can be explained by the gravitational field of the planet capturing the passing asteroids.

§2.2. Dynamic model of expansion and compression of the Universe

In the previous paragraph it was noted that since the average density of matter in the Universe is greater than critical, the evolution of the Universe is cyclic: expansion is followed by compression of the Universe, and compression is followed by expansion, etc. In our opinion, the cyclic evolution of the Universe adequately simulates the functioning of a mathematical pendulum. Equations of motion of the pendulum have the form

$$\dot{p}_1 = -F_1 \sin \varphi_1, \quad \dot{\varphi}_1 = G_1 p_1, \quad (2.12)$$

where p_1 is the impulse, $F_1 = m_1 |\gamma| h_1$, $G_1 = 1/m_1 h_1^2$, $m_1 |\gamma|$ is the force of gravity, i.e. the gravitational force acting on a Galaxy having a mass m_1 , from the side of luminous objects and the dark matter of the Universe (this means that gravitation is created by all kinds of matter), the cumulative mass of which is M , h_1 —length of the pendulum, $\gamma = -\alpha \frac{M}{h_1^2}$ acceleration,

α — Newtonian constant of gravitation; φ_1 — angle of deviation of the pendulum from the vertical.

Let us write the Hamiltonian for the equations of a mathematical pendulum (2.12):

$$H_1 = T_1 + U_1 = E_1$$

or

$$H_1 = \frac{1}{2} G_1 p_1^2 - F_1 \cos \varphi_1 = E_1, \quad (2.13)$$

where $T_1 = \frac{1}{2} G_1 p_1^2$ is the kinetic energy,

$U_1 = -F_1 \cos \varphi_1$ — potential energy,

E_1 — the total energy of the Universe (Metagalaxy).

Let the total energy $E_1 = E_u$ be greater than the maximum value of the potential energy F_1 . In this case, the impulse p_1 is always other than zero; this leads to an unlimited change φ_1 , i.e. to rotation (see Supplement B, case 2). For $p_1 > 0$ the motion is from left to right with energy $+E_u$, and for $p_1 < 0$, the motion is from right to left with the energy $-E_u$. The positive and negative energy in the Universe depends on where (below the $o\varphi_1$ axis or above the axis (see Fig. 4)) we observe the pendulum motion. In the Universe, there are no "bottom" and "top"

concepts, therefore, the symbol of energy "-" is a formality. The relativity of the energy symbol becomes clear when we determine the volume that cannot be a negative value.

We introduce the notation $E_u = F_1 + \Delta E_u$ [22]. We will be interested in the maximum and minimum value of the pulse, which it takes at the limit values of the function $\cos \varphi_1$, i.e. for $\cos \varphi_1 = \pm 1$. Then, according to the Hamiltonian (2.13), we will have (see Fig. 6)

$$p_{1\max} \equiv R_{\max} = \sqrt{\frac{2}{G_1} (F_1 + \Delta E_u)}, \quad (2.14)$$

$$p_{1\min} \equiv R_{\min} = \sqrt{\frac{2\Delta E_u}{G_1}}. \quad (2.15)$$

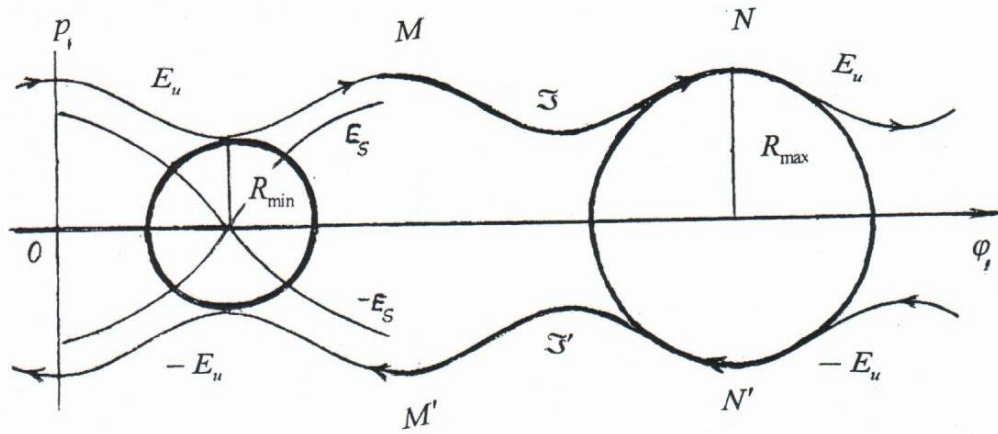

Fig. 6.

Thus, the minimum radius R_{\min} of an expanding imaginary sphere, and the maximum radius R_{\max} , which the imaginary sphere will have after expansion of the Universe, are defined. The minimum radius of an imaginary sphere corresponds to the initial density of matter in the first second of "Creation of the World" [15], i.e. $\rho_0 = 8 \cdot 10^5 \frac{\text{g}}{\text{cm}^3}$, as well as in the compression of the Universe.

To avoid the overload of Fig. 6, the maximum radius of the sphere is shifted to the right for one period from MM' to NN' . The sphere and the trajectory of its motion are denoted by bold curves. Index S of the energy, i.e. E_S indicates that the energy belongs to a separatrix.

Now, let us define the increase of the total energy of the Universe ΔE_u , which appears in the expressions (2.14) and (2.15). To this end, let us turn to formula

$$R_{\min} = \sqrt[3]{\frac{3M^*}{4\pi\rho}}, \quad (2.16)$$

where $M^* = M + m_1$.

Equating the right-hand side part of the formulas (2.15) and (2.16), we determine the magnitude of the increase in the total energy of the Universe

$$\Delta E_u = \frac{G_1}{2} \sqrt[3]{\left(\frac{3M^*}{4\pi\rho}\right)^2}. \quad (2.17)$$

With account of formula (2.17) in expression (2.14), we will have the maximum radius of an imaginary sphere

$$R_{\max} = \sqrt{\frac{2}{G_1} \left[F_1 + \frac{G_1}{2} \sqrt[3]{\left(\frac{3M^*}{4\pi\rho}\right)^2} \right]}. \quad (2.18)$$

Since the equations of the mathematical pendulum (2.12) satisfy Hamilton's equations (A.3) (Supplement A), the evolution of the Universe is optimal in the sense of Hamilton's equations (0.8a) and (0.8b).

§2.3. The physical prerequisites for expansion and compression of the Universe

According to the postulate of physics, matter can exist in two states: substance and field [23]. In the Universe, the process of transition (transformation) of the substance into field and the process of transition of the field into substance occur in parallel to each other. Fig. 7 schematically shows these transitions.

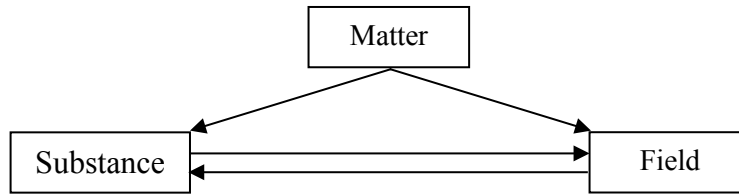

Fig. 7

On the scale of the Universe, these transformations occur at all levels of the matter. On the level of elementary particles, these transformations are described figuratively by M. A. Tonnelat [13]: “At the end, the experiments in which a quantum of electromagnetic radiation with the energy $E_0 = h\nu_0$ ¹ turns into a pair of oppositely charged particles with a common

¹ h -Planck's constant,

ν_0 -frequency of electromagnetic radiation.

energy $2m_0c^2$, as well as experiments in which the opposite process is observed: transformation of the matter into radiation allows us to give meaning to the relation $\Delta E = \Delta mc^2$ in the case when as a result of the reaction the mass arises from radiation or, on the contrary, completely disappears and turns into radiation. “

On the level of stars, the transformation of matter into a field, i.e. in radiation, takes place in the catastrophic explosion of a star at the end of life. This phenomenon is called the flash of a supernova star. The light component (the brightness of the star) is part of the general, sharply increasing radiation (field) emitted during the explosion of the supernova star. The transformation of the field into matter is described in paragraph 2.1, when dark matter is formed in a vacuum curved by a gravitational field.

For the processes of expansion and compression of the Universe, the statement of the founder of modern cosmology, G. Lemaitre is very important, who believed that the Universe consists of particles – Galaxies, which are in the process of either moving in different directions (expansion of the Universe), or moving toward each other (compression of the Universe). As follows from this statement, the expansion of the Universe is accompanied by rarefaction of gas consisting of particles – Galaxies. As already noted, this phenomenon is modeled by the occur of particles – Galaxies on the surface of an imaginary expanding sphere. The expansion model of the Universe, given below, is designed to simulate the process of rarefaction of the average density of matter in the Universe.

Let us now turn to the physical models of expansion and compression of the Universe. As a model of expansion of the Universe, the model of the effect of "closeness" [24] is taken: the closer each Galaxy is to other Galaxies, the worse it is for it, i.e., the greater the concentration of Galaxies, the worse. Therefore, the term describing the concentration decrease of the Galaxies must be proportional to z^2 :

$$\frac{dz_+}{dt} = \beta_+ z_+ - \mu_+ z_+^2, \quad (2.19)$$

where z_+ is the density of matter in an imaginary expanding sphere.

Another model simulating the compression of the Universe is:

$$\frac{dz_-}{dt} = -\beta_- z_- + \mu_- z_-^2, \quad (2.20)$$

where z_- is the density of matter in a compressing sphere.

Equation (2.20) is called the model of "super-closeness". This model is that the closer each Galaxy is to other Galaxies, the better it is for it, i.e., the greater the concentration of Galaxies the better. ***The models (2.19) and (2.20) are Riccati equations without a free term; the integral***

from the soliton (see (0.7a) and (0.7b)) that satisfies the Euler-Lagrange equation, i.e. these models are optimal.

Although the density of substance y is many times more than the field density x , for a large mass of the field their competitive behavior becomes real. Soon after the Big Bang, the radiation, i.e. the field made a much larger contribution to the density of matter than the substance. This period is called the "radiation era"¹. As is known, the competitive behavior of two variables x and y are adequately modeled by the Lotka-Volterra equations - the "predator-prey" equations. The expediency of application of these equations in modeling the Big Bang is given in Supplement C.

The report [25] shows that if for two competing variables x and y , satisfying the system of Lotka-Volterra equations predator-prey, the stable

$$\begin{aligned} \frac{dx}{dt} &= ax - bxy, & a, b > 0, \\ \frac{dy}{dt} &= cxy - dy, & c, d > 0, \end{aligned} \quad M$$

and the instable

$$\begin{aligned} \frac{dx}{dt} &= ax - bxy, & a, b > 0, \\ \frac{dy}{dt} &= dy - cxy, & c, d > 0, \end{aligned} \quad N$$

for denotation $z = xy$ and the condition according to which the rate of change in the density of matter z is constant, i.e.

$$\dot{z} / z = \pm q = \text{const} \quad (2.21)$$

the transition from systems M and N to the modified Riccati equation can be carried out [25]

$$\frac{dz}{dt} = -(d \mp q)z + \frac{bc}{a \mp q} z^2. \quad (2.22)$$

For explaining the role of the parameters a and b in the first equation of the system M , let us represent the equation in the tempo record:

$$\frac{dx}{dt} = a - by. \quad (2.23)$$

¹Silk J. The Big Bang. The birth and evolution of the Universe. Moscow: Mir, 1982

It is clear from the expression (2.23) that the parameter a describes the rate of production of the field density $x = \rho(x)$; parameter b is the weight coefficient for the density of substance $y = \rho(y)$ in equation (2.23).

Similarly, to identify the assignment of parameters c and d in the second equation of the system M , we represent this equation in a tempo form:

$$\frac{dy}{dt} = cx - d. \quad (2.24)$$

Equation (2.24) shows that the parameter d characterizes the rate of production (formation) of the density of substance $y = \rho(y)$, and the parameter c is the weighting factor for the field density $x = \rho(x)$.

It should be noted that equation (2.22) includes equation (2.19) modeling the expanding Universe, and equation (2.20) modeling the compressing Universe; all depends on the choice of coefficients for z and z^2 .

Let us now define the parameter q . To this end, the solution of (2.22) will be sought in the class of generalized functions [22]. Actually, let us turn to equations

$$\pm \frac{d\chi}{dt} = \frac{1}{\psi}, \quad (2.25)$$

$$\frac{d\psi}{dt} = \frac{1}{\chi}. \quad (2.26)$$

From equations (2.25) and (2.26) it follows that

$$\pm \frac{d\chi}{d\psi} = \frac{\chi}{\psi} \Rightarrow \pm \frac{d\chi}{\chi} = \frac{1}{\psi} \Rightarrow (\ln|\pm \chi|)'_{\psi} = \frac{1}{\psi}. \quad (2.27)$$

If in formula (2.27) we substitute χ by z , and substitute ψ by current time t , then denote

$$z = z_0 \ell^t, \quad (2.28)$$

(z_0 is the value of matter density in equilibrium state: $a = \frac{bcz_0}{d}e$, and letter e denotes the

Napier's number, i.e.. $e = 2.7182 \dots$) with account of (2.21), we will have

$$\frac{1}{t} = \dot{z} / z = (\ln|\pm z|)'_t = \ln \ell = \pm q \quad (2.29)$$

Expression (2.29) shows that the parameter q belongs to the class of generalized functions.

We divide both sides of equation (2.22) by z , then with account (2.21) we obtain equality

$$\pm q = -d \pm q + \frac{bc}{a \mp q} z$$

From the last expression we define z :

$$z = \frac{d(a \mp q)}{bc}. \quad (2.30)$$

According to the relation (2.29), the expression (2.30) and the notation (2.28) can be written as follows

$$z_0 t \ln \ell = \ln \left| \frac{d(a \mp q)}{bc} \right| \Rightarrow e = \pm \left(\frac{d(a \mp q)}{bcz_0} \right). \quad (2.31)$$

From the relation (2.31) we obtain two formulas

$$q_1 = \pm \left(a - \frac{bcz_0}{d} e \right), \quad (2.32)$$

$$q_2 = \pm \left(a + \frac{bcz_0}{d} e \right). \quad (2.33)$$

Root q_2 (2.33) is not suitable, because it corresponds only to the compressing or only to the expanding Universe: $z = z_0 e^{q_2 t} \rightarrow \infty$ for $t \rightarrow \infty$ or $z = z_0 e^{-q_2 t} \rightarrow 0$ for $t \rightarrow \infty$.

From the first expression it follows that the density of matter tends to infinity.

Root q_1 (2.32) can be used in modeling the expanding Universe for $\frac{bcz_0}{d} e > a$, and in the modeling of a compressing Universe for $a > \frac{bcz_0}{d} e$. In equation (2.22), the parameter q implies root q_1 . Consequently, the density of matter corresponding to the root q_1 will be written as follows

$$z = z_0 e^{q_1 t}. \quad (2.32a)$$

Thus, for a constant rate (2.21) of change of the matter density $z(z = xy)$, formula (2.32a) determines the total density of the field x and the substance y in the form of an exponential function, consisting of the production of the current time t , difference $q_1 = a - \frac{bcz_0}{d} e$

characteristic of the relationship between the weight coefficients of the field (a, d) , the substance (b, c) and the value of the total density of the matter in the equilibrium state $z_0 = \frac{a_0 d_0}{b_0 c_0 e}$, where the parameters a_0, b_0, c_0, d_0 correspond to the equilibrium state of the

parameters a, b, c, d , for which equality

$a - \frac{bcz_0}{d}e = 0$ holds.

Consequently, for an expanding Universe, i.e. for the equation (2.19), the parameters β_+ and μ_+ are defined as follows

$$\left\{ \begin{array}{l} \beta_+ = -(d+q) = -d - a + \frac{bcz_0}{d}e > 0 \Rightarrow \frac{bcz_0}{d}e > a+d, \\ \mu_+ = \frac{bc}{a-q} = \frac{bc}{a + \frac{bcz_0}{d}e - a} = \frac{d}{z_0e} > 0. \end{array} \right. \quad (2.34)$$

For a shrinking Universe, i.e. for the equation (2.20), the parameters β_- and μ_- are found from expressions

$$\left\{ \begin{array}{l} \beta_- = q - d = a - \frac{bcz_0}{d}e - d > 0 \Rightarrow a - d > \frac{bcz_0}{d}e, \\ \mu_- = \frac{bc}{a+q} = \frac{bc}{a + a - \frac{bcz_0}{d}e} = \frac{bcd}{2ad - bcz_0e} > 0 \quad \text{for } 2ad > bcz_0e. \end{array} \right. \quad (2.35)$$

So long as we have inequality $ad > bcz_0e + d^2$ then condition $2ad > bcz_0e$ is in excess; its automatic realization.

The imaginary sphere (Fig. 6) moves from left to right: the size of the sphere increases, which corresponds to the expansion of the Universe that is currently taking place; this causes the corresponding process of rarefaction of the matter. The state of the sphere MM' is characterized by a stable position: the radius of the sphere is maximum, i.e. we have R_{max} , and the density of matter reaches minimum ρ_{min} . After the MM' state the sphere begins compression; this process ends in a state $\mathfrak{S}\mathfrak{S}'$, when the density reaches maximum value ρ_{max} , and the radius of the sphere becomes minimum R_{min} . Further, according to the model of the pendulum, the process of expansion and compression of the Universe repeats.

§2.4. Solution of the equations of the pendulum functioning in the Universe for separatrix, vibrational and rotational motions. Determination of the volume corresponding to the oscillatory motion of the pendulum of the Universe. Determination of the separatrix surface in the Universe. Curvature of the Universe

In the present and in the next section, instead of acceleration of the free fall of a pendulum operating in terrestrial conditions, the acceleration $\gamma = -\frac{\alpha M}{h_1^2}$, more precisely, the absolute value of this acceleration corresponding to a pendulum functioning on the scale of the Universe will be discussed. The structure of the equation of the pendulum of the Universe (2.12) remains the same.

1. Solving the equations of the pendulum of the Universe corresponding to the separatrix.

The differential equations for the separatrix of the pendulum (B.6 a) and (B.6b) (Supplement B, case 2b) remain in effect

$$p_1' = \operatorname{sech}^2(\varphi_1 - \varphi_0), \quad (2.36)$$

$$p_2' = -\operatorname{sech}^2(\varphi_1 - \varphi_0), \quad (2.37)$$

where the angle of rotation of the separatrix is determined by the formula (B.7).

The solutions of the differential equations (2.36) and (2.37) allow to determine the impulses corresponding to separatrices moving from left to right and from right to left:

$$p_1 = \int_{\varphi_0}^{\varphi_1} \operatorname{sech}^2(\varphi_1 - \varphi_0) d\varphi_1, \quad (2.38)$$

$$p_2 = -\int_{\varphi_1}^{\varphi_0} \operatorname{sech}^2(\varphi_1 - \varphi_0) d\varphi_1. \quad (2.39)$$

As already noted above, the separatrix is not a set, but a line having the length but not the breadth.

Solutions (2.38) and (2.39) correspond to the values of the energies E_s and $-E_s$ corresponding to the separatrix of the pendulum of the Universe (see Fig. 4b, number 3).

2. A set corresponding to the oscillatory motion of the pendulum of the Universe.

In this case, the inequalities for energies E_1 and $-E_1$ are given by (Fig. 4b, number 2):

$$E_s > E_1 \geq 0, \quad (2.40a)$$

$$-E_s < -E_1 \leq 0, \quad (2.40b)$$

where E_1 is the total energy of the pendulum.

As already noted (see the text after formula (2.13)), the negative energy $-E_1$ in the Universe is absent; this concept is relative: the positive and negative energy depends on the location of the observer in relation to the axis $0\varphi_1$. We use the axis $0\varphi_1$ (for which

$\varphi_1 = \omega_1 t$, $\omega_1 = \sqrt{\frac{\alpha M}{h_1^3}}$), since from the pendulum functioning in terrestrial conditions (see Fig.

4) we go to the pendulum of the Universe. If the observer is below the axis $0\varphi_1$, then we have inequalities (2.40) and (2.40b). If the observer is above the axis $0\varphi_1$, then the negative energy (2.40b) becomes positive (2.40) and vice versa. This can also be interpreted by using the equivalence symbol “ \equiv ” applicable to integrals

$$\int_a^b \equiv -\int_b^a.$$

The negative impulse p negative energy corresponds $-E$ that can be verified by elementary reasoning. According to formula $p = mv$, if the impulse p is negative, then the mass m will be negative and consequently, energy $E = mc^2$ will also be negative. Since the negative mass has no physical meaning, the existence of negative energy is nonsense.

The oscillatory motion of the pendulum of the Universe corresponds to the formula (B.2)

substituted in it parameter $\omega = \sqrt{\frac{g}{h}}$ by parameter $\omega_1 = \sqrt{\frac{\alpha M}{h_1^3}}$:

$$p_1 = k_{\pm} \operatorname{sn} \left[\sqrt{\frac{\alpha M}{h_1^3}} (t - t_0), k_{\pm} \right]. \quad (2.41)$$

Formula (2.41) has the property of symmetry with respect to the axis $0\varphi_1$ (see Fig. 4b); for the parameter value k_+ , belonging to the interval $\pm(0 \dots, k, \dots, 1)$, i.e. $k_+ \in +(0 \dots, k, \dots, 1)$ (Supplement B), it describes the upper part (with respect to the axis $0\varphi_1$) of set 2, and for $k_- \in -(0 \dots, k, \dots, 1)$, describes the mirror reflection of the upper part of this set relative to the

axis $0\varphi_1$, which is below the axis $0\varphi_1$ and therefore $k_- = -k_+$. Since the set 2 is closed, the initial condition t_0 can be omitted. The argument in the last formula can be presented in appropriate corner (see B.7):

$$p_1 = k_{\pm} \operatorname{sn}(\varphi_1, k_{\pm}). \quad (2.42)$$

According to the well-known properties of Jacobi's elliptic function sn , the oscillatory motion is periodic, having a period

$$T = 4\omega_1 K, \quad (2.43)$$

where

$$K = \int_0^1 \left[\sqrt{1-t^2} \sqrt{1-k^2 t^2} \right]^{-1} dt.$$

3. A set corresponding to the rotational motion of the pendulum of the Universe.

In this case, the inequalities for energies have the form (see Fig. 4b, number. 1):

$$E_u \geq E_1 > E_s,$$

$$-E_u \leq -E_1 < -E_s.$$

The rotational motion of the pendulum of the Universe corresponds to the formula (B.3) again

by substitution its parameter $\omega = \sqrt{\frac{g}{h}}$ by parameter $\omega_1 = \sqrt{\frac{\alpha M}{h_1^3}}$:

$$p_1 = \operatorname{sn} \left(\sqrt{\frac{\alpha M}{h_1^3}} \cdot \frac{t-t_0}{k_{\pm}}, k_{\pm} \right). \quad (2.44)$$

Formula (2.44) has the property of symmetry about the axis $0\varphi_1$ (see Fig. 4b); for the parameter value k_+ belonging to the interval $\pm(0 \dots, k, \dots, 1)$, $k_+ \in +(0 \dots, k, \dots, 1)$ (see Supplement B), it describes the upper part (with respect to the axis $0\varphi_1$) set 1, which extends to a separatrix 3, and for $k_- \in -(0 \dots, k, \dots, 1)$, describes a mirror image of this set below the axis $0\varphi_1$ and therefore $k_- = -k_+$. So far as $\operatorname{sn}(\cdot)$ is odd function, then $p_1(2.44)$ is symmetric to the axis $0\varphi_1$.

Last expression can be presented in following form (see B.7):

$$p_1 = \operatorname{sn} \left(\frac{\varphi_1 - \varphi_0}{k_{\pm}}, k_{\pm} \right). \quad (2.45)$$

4. Determination of the volume corresponding to the oscillatory motion of the pendulum of the Universe.

The volume of the ellipsoid W corresponding to the oscillatory motion, formed by rotating the expression (2.42) about the axis $0\varphi_1$, is found by formula

$$W = \pi k^2 \int_{-n}^n \text{sn}^2(\varphi_1, k) d\varphi_1. \quad (2.46)$$

The Jacobi elliptic function sn is determined in the form of a convergent series

$$\text{sn}(x, k)^1 = x - (1 + k^2) \frac{x^3}{3!} + (1 + 14k^2 + k^4) \frac{x^5}{5!} - (1 + 135k^2 + 135k^4 + k^6) \frac{x^7}{7!} + \dots,$$

where $-n$ and n are the extreme points of the major axis of the ellipsoid (Fig. 8), formed as a result of rotation of the function (2.42) about the axis $0\varphi_1$, i.e. they characterize the length of the major axis of the ellipsoid equal to

$$L_3 = n + |-n| = 2n. \quad (2.47)$$

The length L_3 is found as the product of the speed of movement of Galaxy V in the ellipsoid for t_n time of the Galaxy's motion about the major axis of the ellipsoid

$$L_3 = Vt_n. \quad (2.48)$$

The transit time is determined by using formula (2.43). Comparing expressions (2.47) and (2.48), the value of point n can be found and the volume of the ellipsoid be determined by formula (2.46).

¹Determination of the terms in the expansion of the Jacobi function is given in F. Tricomi's monograph: Differential Equations. Moscow: IL., 1962.

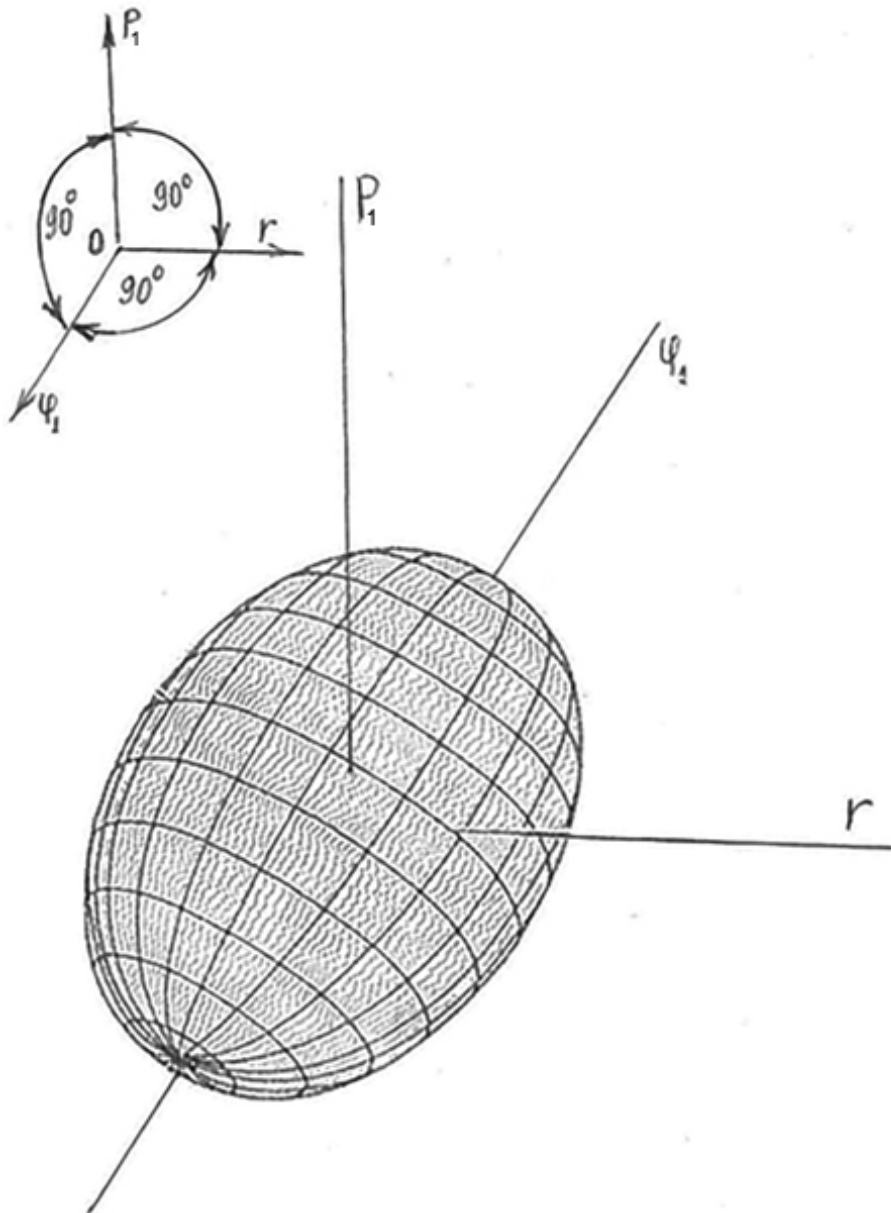

Fig. 8

5. Definition of the separatrix surface in the Universe.

In §1.7 it was shown that motion along a separatrix means a trajectory motion that provides a relativistic effect. The effect is the same for motion along a separatrix surface. Therefore, it is of interest to find the surface area formed by the rotation of the separatrix 3 (see Fig. 4b) about the axis $0\varphi_1$, with the angle φ replaced by the rotation angle of the pendulum of the Universe φ_1 , defined according to (B.7).

The separatrix φ_s consists of two sections: a concave section φ_{s-} (BA) and a convex section φ_{s+} (BC). Therefore, the area Q formed by the rotation of the separatrix 3 about the axis $0\varphi_1$ is represented as the sum of the areas formed by the rotation of these sections around the axis $0\varphi_1$:

$$Q = 2\pi \left| \int_0^{m\pi} (-4\text{arctg}(e^{-\varphi_1})) \sqrt{1 + \left(\frac{-4d\text{arctg}(e^{-\varphi_1})}{d\varphi_1} \right)^2} d\varphi_1 \right| +$$

$$+ 2\pi \int_{m\pi}^{m2\pi} 4\text{arctg}(e^{\varphi_1}) \sqrt{1 + \left(\frac{4d\text{arctg}(e^{\varphi_1})}{d\varphi_1} \right)^2} d\varphi_1, \quad (2.49)$$

$2\pi m$ is the number corresponding to the extreme point of the separatrix of the Universe.

The first syllable in (2.49) is the area of the pseudo-Riemannian surface, and the second corresponds to the area of the Riemannian surface.

6. Curvature of the Universe.

As the curvature of the Universe, we take the reciprocal of the current radius of the imaginary sphere, on the surface of which there are particles - Galaxies:

$$K_+ = \frac{1}{R_+} \quad (2.50)$$

for the expanding Universe and

$$K_- = \frac{1}{R_-} \quad (2.51)$$

for a compressing Universe.

In formulas (2.50) and (2.51), the radius of the imaginary expanding and compressing spheres are determined from the well-known expressions:

$$R_+ = \sqrt[3]{\frac{3M^*}{4\pi z_+}} \quad (2.52)$$

and

$$R_- = \sqrt[3]{\frac{3M^*}{4\pi |z_-|}}. \quad (2.53)$$

The densities of matters z_+ and z_- are determined according to formulas (B.8e) and (B.8f). Since the negative density of matter z_- is deprived of physical meaning, in the formula (2.53) this value is determined by using the symbol of the absolute value $|z_-|$.

It follows from (2.50) and (2.51) that over time the curvature of the expanding and compressing Universe, i.e. for $t \rightarrow \infty$ and $t' \rightarrow \infty$ decreases and increases, correspondingly; this can be seen from the analysis of formulas (2.50), (2.52), (B.8e) and (2.51), (2.53), (B.8f).

Since the results of this section follow directly from the equations of a mathematical pendulum that satisfy the Hamilton equations (0.8a) and (0.8b), the results given in points 1-6 are optimal.

§2.5. Hypothetical model of the formation of an elliptical Galaxy

In the fifties of the 20th century, K.F. vonWeizsäcker hypothesized the whirlpool nature of formation of the Galaxies. This hypothesis was shared by G.A. Gamow, the author of the theory of the hot Universe. The model of the evolution of the Universe proposed by us (see §2.4; 2 and 4) confirms the possibility of the whirlpool nature of formation of the Galaxies. *Indeed, in the oscillatory motion of the mathematical pendulum of the Universe, a region is formed in the form of an elongated ellipsoid of energy (Fig. 8), in which there are lines of whirl of the gravitational field E_1 , i.e. vector field lines $\text{rot}E_1$ these lines satisfy expression*

$$\text{divrot } E_1 = 0,$$

which implies that the lines of whirl have no beginning and no end. The lines of whirl are closed on the plane (Fig. 4b, number 2) and in space (Fig. 9). Total energy E_1 is proportional of the impulse p_1 . for our case ($E_1=E_b$) we have $E_1=Jp_1$, where $J= c^2/v$ and v is velocity of stars. The stars that fall into the ellipsoid of energy move along the corresponding lines of whirl. The form (shape) of the Galaxy depends on the lines of whirl of the energy ellipsoid and the angle at which the stream of stars falls. Therefore, for formation of a Galaxy of a certain shape, the star's entering place in the elongated energy ellipsoid (in front or on the side) and angle of their entering into the ellipsoid are significant.

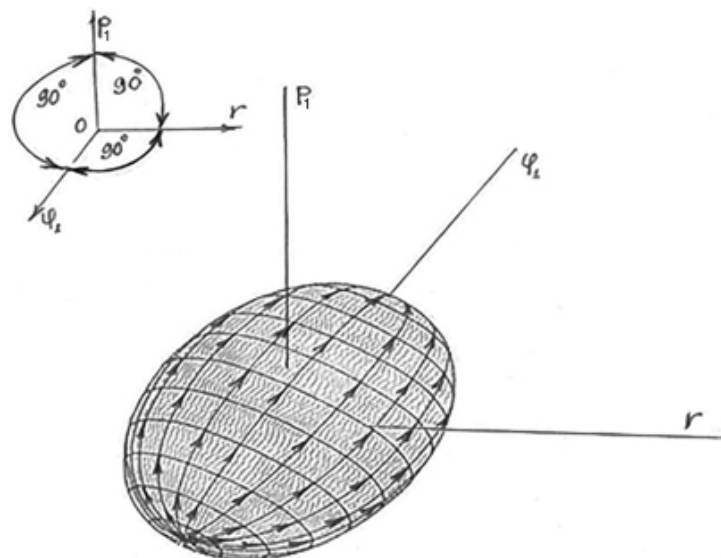

Fig. 9

The trajectories of a stream of stars drawn by the gravitational field of an energy ellipsoid can have three possible locations in relation to the axes of a (large and small) energy ellipsoid:

- along the whirling motion,
- across the whirling motion,
- arbitrary arrangement with respect to the axes of the ellipsoid.

These three trajectories of the stream of stars completely determine the forms of all (except elliptical) Galaxies: disk-shaped, wheel-shaped, spiral, spherical, peculiar, irregular-shaped, etc.

The characteristic dimensions of the Galaxies are 500.000 light years.

Rotation of Galaxies is a strong argument in favor of their whirl origin.

The stars, in all the Galaxies listed above, move in their orbits deterministically. In elliptical Galaxies, the stars move almost chaotically [26]. Therefore, we used the model of the surface of the strange attractor [27] simulating an almost chaotic motion for modeling the chaotic motion of stars.

The formation of ordinary (non-elliptical) Galaxies occurs only under the influence of the lines of whirl of the gravitational field of the energy ellipsoid. In an elliptical Galaxy, the imaginary plane with the trajectory of the stars drawn by the gravitational field of the energy ellipsoid into this ellipsoid is deformed. This deformation can be verbally described as follows.

Each star moving along the trajectory (see Fig. 10a) has a definite mass and a corresponding electromagnetic field. Gravitational whirling motion in the energy ellipsoid occurs around the small axis of the ellipsoid, and the rotational motion of the electromagnetic field in the ellipsoid induced by the motion of stars in the flow, occurs around the major axis of the ellipsoid.

For formation of an elliptical Galaxy, the stream of stars moving along the corresponding trajectory is drawn by the gravitational field of the energy ellipsoid into the front region of the ellipsoid parallel to the axis $0\varphi_1$ or, at best, this trajectory coincides with the axis $0\varphi_1$ (Fig. 11a). Because of the impact on the imaginary plane of the electromagnetic field of stars, there is an effect causing stretching of the imaginary plane (Fig. 10a). It is known that stars, like the Sun, have a positive charge. Consequently, in the energy ellipsoid the stream of stars moving along the trajectory induces electromagnetic field rotating around the axis $0\varphi_1$. This rotating field acts on a stretched imaginary plane, forming a fold (Fig. 10a). Further, in the energy ellipsoid the rotational motion together with the gravitational motion causes the rotation of the fold and its motion. As a result, the lines AB and $A'B'$ are smoothly connected with each other.

The final form of the strange attractor is shown in Fig. 10b. Here, the imaginary plane, on which the trajectory of the stars is located, is deformed.

Thus, in formation of an elliptical Galaxy, two fields are involved: the gravitational field of the energy ellipsoid and the electromagnetic field induced by the stream of stars. Fig. 11a shows the general view of the energy ellipsoid together with the trajectory of the stream of stars, and Fig. 11b shows the appearance of an elliptical Galaxy formed by the combined action of gravitational and electromagnetic fields on an imaginary plane (Fig. 10a), on which the trajectory of stars is located.

The elliptical Galaxy is referred to in the English-language literature by the cat's eye Galaxy.

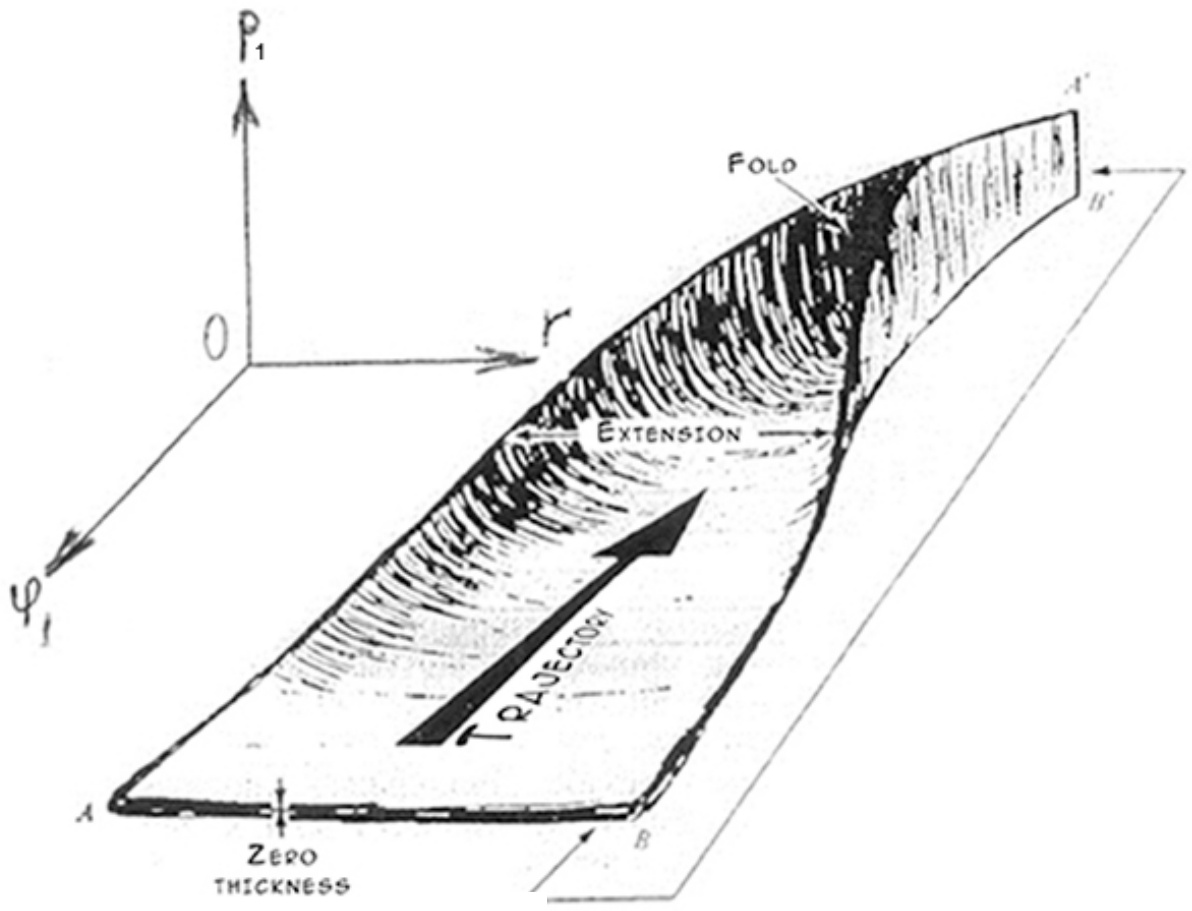

a

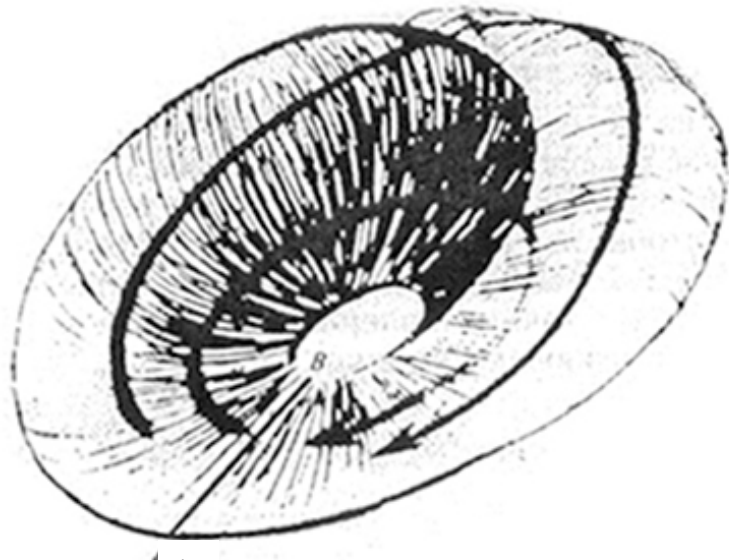

b

Fig. 10

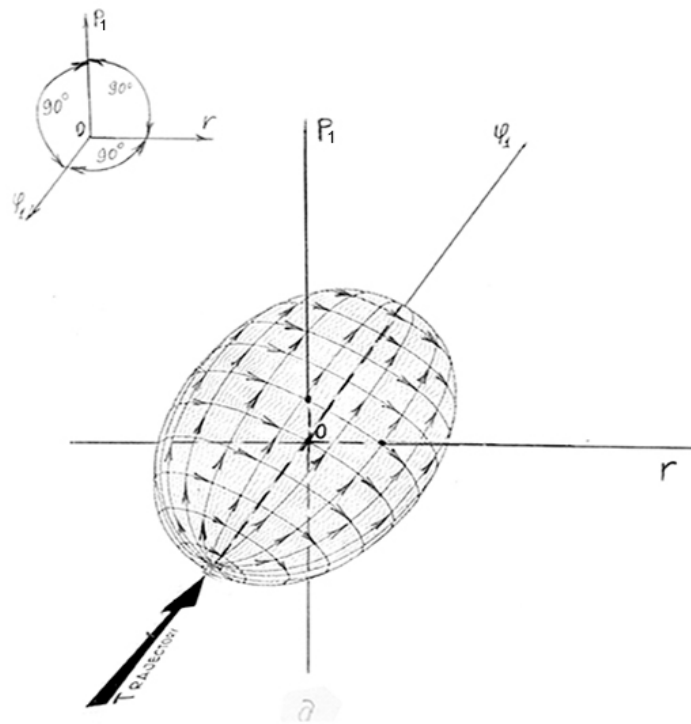

a

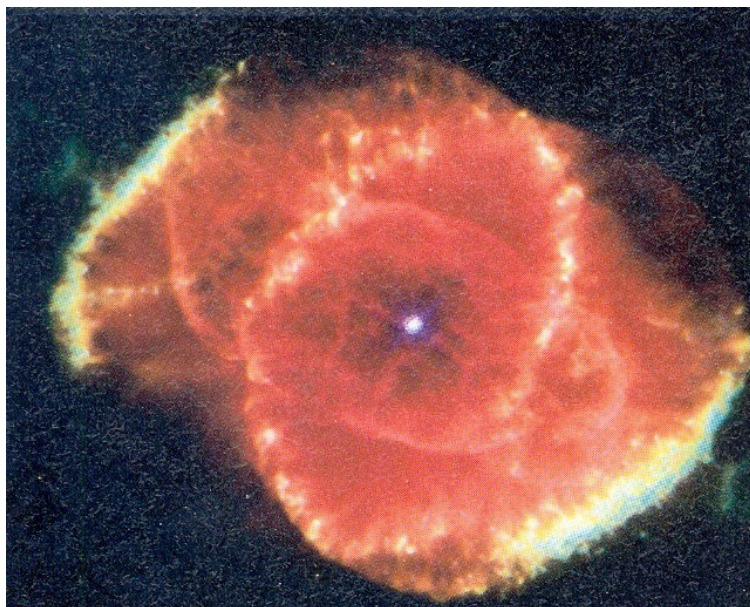

b

Fig. 11

§2.6. Using the equations of mathematical pendulum for modeling the star systems for Galaxy

When modeling the motion of stars in the Galaxy, the main task is to analyze the nature of the gravitational forces of other stars acting on the star of our interest. General considerations require classification of these forces. It is necessary to distinguish the action of the gravitational field of the entire Galaxy and the local action of the field of stars of the surrounding neighborhood: in the first case, we have a gravitational force in the form of a smoothly changing function of space and time, and in the second case, a force subjected to relatively rapid fluctuations [28]. On the scale of our Galaxy we do not know the form of the probability density function of some random process corresponding to these fluctuations. For other forms of Galaxies, this density will be different. Based on these considerations, we will choose the first case, i.e. we use this force in modeling the functioning of a mathematical pendulum on the scale of the Galaxy.

To this end, we use the results of Holzmark for definition of the gravitational force acting on the star. Holzmark [29] found a stationary distribution

$$W(|f|) = H(\beta)/Q_H$$

for gravitational force f , acting on the star from the side of other stars and determined this force acting per unit mass

$$|f| = \beta Q_H, \quad (2.54)$$

where β is the Holzmark distribution parameter

$$H(\beta) = \frac{2}{\pi\beta} \int_0^{\infty} \exp\left[-(x/\beta)^{3/2}\right] x \sin x dx,$$

and

$$Q_H \equiv a^{2/3},$$

where

$$a = (4/15)(2\pi\alpha)^{3/2} \left\langle m_2^{3/2} \right\rangle_N n,$$

$$\left\langle m_2^{3/2} \right\rangle_N = \int_0^{\infty} m_2^{3/2} \omega(m_2) dm_2,$$

$\omega(m_2)$ is the frequency of meeting the stars of different masses m_2 ,

N – the number of stars in the Galaxy; in our Galaxy this number is equal to: $N = 2 \cdot 10^{11}$,

α – the Newtonian constant of gravitation,

n – the density of distribution of stars in the Galaxy, i.e. magnitude of the concentration of stars.

The structure of the mathematical pendulum remains the same as in the case of the pendulum functioning in terrestrial conditions and in conditions of the Universe

$$\dot{p}_2 = -F_2 \sin \varphi_2, \quad \dot{\varphi}_2 = G_2 p_2. \quad (2.55)$$

In equations (2.55) we have the parameters corresponding to the stellar system (Galaxy): $F_2 = h_2 m_2 |f|$, where $m_2 |f|$ is the gravitational force acting on a star having a mass m_2 , h_2 is the length of the pendulum, denoting the distance from the star of interest to the center of the averaged mass of stars of the Galaxy, φ_2 is the angle of deviation of the pendulum from the vertical, p_2 is the impulse, and $G_2 = 1 / m_2 h_2^2$.

Thus, the substitution of force $|f|$, determined by (2.54), in the first equation (2.55) allows us to use a pendulum to model the gravitational field in the scale of the Galaxy.

From the results of this section it follows that the evolution of the stellar system in the Galaxy obeys the Hamiltonian system (2.55), which satisfies the Hamilton equation (0.8a). Consequently, the evolution of the stellar system is optimal.

According to GTR, the gravitational field of a spherical body cannot depend on time regardless of the fact whether the distribution of matter creating the field is at rest or spherically - symmetrically expands in space in a radial direction. For generalized structure of this gravitational field, it does not matter whether it is created by the sun (considered as a spherical object), by a neutron or a collapsing star. Only the active gravitational mass (equal to the inertial mass) and the radius of the extinguished star influence the gravitational field of the star.

Independence from time, i.e. the stationarity of the gravitational field created by this body is easily justified by using the Euler-Lagrange equation. Potential energy U of the gravitational field is the Lagrangian for equation

$$\frac{\partial U}{\partial q} - \frac{d}{dt} \frac{\partial U}{\partial p} = 0, \quad (2.56)$$

where $q \equiv \varphi$ is the cyclic coordinate.

Since equation (2.56) contains a cyclic coordinate, it will be written as follows

$$\frac{d}{dt} \frac{\partial U}{\partial p} = 0.$$

Integration of the last equation with respect to t gives

$$\frac{\partial U}{\partial p} = const.$$

The last equation is stationary. Consequently, the gravitational field, as required by GTR, does not depend on time.

§2.7. Hypothetical model explaining emissions of luminous matter from the nucleus of the Galaxy

In the forties of the twentieth century, the well-known scientist and astrophysicist Academician V.A. Ambarzumian observed an unusual phenomenon: the emission of a glowing substance from the core of the Galaxy [30]. This surprising phenomenon did not receive an adequate explanation. In our opinion, the situation is as follows.

In the core of the Galaxy there is a supermassive clot of gravitational energy. The electromagnetic wave of the Galaxy, colliding with this clot of energy, is reflected from it. As a result of reflection from a clot of gravitational energy, the electromagnetic wave already has a different wavelength, which is in the visible range of waves. This means that an invisible electromagnetic wave becomes visible to the human eye, which creates the effect of throwing a glowing substance out of the core of the Galaxy. Consequently, in fact, there is no emission of a glowing substance from the core of the Galaxy, and the observer sees reflected electromagnetic waves.

* * *

From the opinion of outstanding scientist, cited in the epigraph to this chapter, it follows that they considered the Universe to evolve in an optimal way. As shown in this chapter, the optimal arrangement of the Universe means that the process of its evolution must obey the optimization equations. In the times of I. Newton and A. Einstein, the classification of systems dividing them into conservative and dissipative one was not used. The apparent stationarity of the Universe misled Einstein when he considered the Universe (like Newton) a conservative system and recorded its equations of the gravitational field with the constant Λ , corresponding to the forces of vacuum repulsion, i.e. negative energy. In his subsequent statements, Einstein called "the biggest blunder of his life" with respect to term Λ ¹. The results of this chapter show that the Universe is a dissipative system whose optimization equations obey its evolution.

¹The possibility of the existence of a quantum vacuum that takes place in difficult-to-comprehend time and space intervals was not considered by Einstein.

**MATHEMATICAL
SUPPLEMENT**

Supplement A

Optimality of the equations of a mathematical pendulum. Optimality of the separatrix equation for a mathematical pendulum and connection of this equation with the sine-Gordon equation

Equations of a mathematical pendulum have the form

$$\dot{p} = -F \sin \varphi, \quad \dot{\varphi} = Gp, \quad (\text{A.1})$$

where $F = hmg$, $G = 1/mh^2$, mg is the force of gravity acting on the mass m , h is the length of the pendulum, φ is the angle of deviation from vertical, and p is the angular momentum. The Hamiltonian, as already noted, is the sum of the kinetic energy $\frac{1}{2}Gp^2$ and potential energy

$$U = -F \cos \varphi:$$

$$H = \frac{1}{2}Gp^2 - F \cos \varphi = E. \quad (\text{A.2})$$

The value of the Hamiltonian E corresponds to the total energy of the system (A.1). The motion of the pendulum for different values of the energy E (Fig. 4a) is shown in Fig. 4b. If E is greater than the maximum value of the potential energy, then the impulse is always other than zero. This leads to an unlimited change φ , i.e. to rotation (see Supplement B, case 2a). In this case, $p > 0$ motion is from left to right with energies E_u . For $E < F$ the motion is limited (within the potential pit) and corresponds to the oscillations of the pendulum (see Supplement B, case 1). If $E = F \equiv E_s$, then the motion occurs along the separatrix (see Supplement B, case 2b). Motion has two special points for $p = 0$; one is at the origin of the coordinate for $\varphi = 0$ and is stable or elliptic singular point, the other (at the junction of the two branches of the separatrix for $\varphi = \pm\pi$) is an unstable or hyperbolic singular point.

The coordinate φ and impulse p of the mathematical pendulum satisfy the Hamilton equation (0.8a) and (0.8b)

$$\frac{d\varphi}{dt} = \frac{\partial H}{\partial p} = Gp, \quad \frac{dp}{dt} = -\frac{\partial H}{\partial \varphi} = -F \sin \varphi \quad (\text{A.3})$$

Now let us find the separatrix equation, using the Hamiltonian (A.2) and condition $E = F$, when the module of the elliptic function k is equal to $k = \pm 1$ (see Supplement B case 2b):

$$p_s = \frac{2^{1/2} \omega_0}{G} (1 + \cos \varphi_s)^{1/2}, \quad (\text{A.4})$$

where $\omega_0 = (FG)^{1/2}$, and index S corresponds to the values of the variables on the separatrix (Fig. 4b).

From (A.4) it follows

$$p_s = \pm \frac{2\omega_0}{G} \cos \frac{\varphi_s}{2}, \quad (\text{A.5})$$

where plus and minus correspond to the upper and lower branches of the separatrix.

Application of the first Hamiltonian equation (A.3), with account (A.5), gives

$$\frac{d\varphi_s}{dt} = \pm 2\omega_0 \cos \frac{\varphi_s}{2}. \quad (\text{A.6})$$

Solving equation (A.6) with respect to dt and integrating with the initial condition

$\varphi = 0$ for $t = 0$, we will have

$$\pm \omega_0 t = \int_0^{\varphi_{s\pm}} \frac{d(\varphi/2)}{\cos(\varphi/2)} = \text{Intg} \left| \frac{\varphi_s}{4} + \frac{\pi}{4} \right|. \quad (\text{A.7})$$

Expression (A.7) requires a joint (integral) representation of the masses ω_0 and time t .

The formula (A.7) can be written separately for the plus and minus signs in the function

$$\text{Intg} \left[\left| \pm \left(\frac{\varphi_{s\pm}}{4} + \frac{\pi}{4} \right) \right| \right]:$$

$$+\omega_0 t = \int_0^{\varphi_{s+}} \frac{d(\varphi/2)}{\cos(\varphi/2)} = \text{Intg} \left(\frac{\varphi_{s+}}{4} + \frac{\pi}{4} \right), \quad (\text{A.7a})$$

$$-\omega_0 t = \int_0^{\varphi_{s-}} \frac{d(\varphi/2)}{\cos(\varphi/2)} = \text{Intg} \left[\left| - \left(\frac{\varphi_{s-}}{4} + \frac{\pi}{4} \right) \right| \right]. \quad (\text{A.7b})$$

The choice of the sign in formulas (A.7a) and (A.7b) is made in accordance with the direction of the separatrix motion shown in Fig. 4b.

After the reversal of formulas (A.7a) and (A.7b), we will have

$$\varphi_{s+} = 4 \arctg [\exp(\omega_0 t)] - \pi, \quad \text{for } \omega_0 t \in [\pi, 2\pi], \quad (\text{A.8a})$$

$$\varphi_{s-} = -4 \arctg [-\exp(\omega_0 t)] + \pi, \quad \text{for } \omega_0 t \in [0, \pi]. \quad (\text{A.8b})$$

In Fig. 4b the section BA of the separatrix ABC, is equal to

$$\varphi_{|s-|} = |-4 \arctg [\exp(-\omega_0 t)]| + \pi, \quad \text{for } \omega_0 t \in [0, \pi] \quad (\text{A.8c})$$

without taking into account the direction of motion of the separatrix.

Consequently, the formula (A.8c) is considered on the descending section of the separatrix 3; The segment BC of the separatrix ABC is determined by the formula (A.8a). On the whole, the entire separatrix ABC (Fig. 4b) is the sum of these sections:

$$\varphi_{SABC} = \varphi_{s-} + \varphi_{s+} = \left| -4\text{arctg}[\exp(-\omega_0 t)] \right|, \omega_0 t \in [0, \pi] + \\ + 4\text{arctg}[\exp(\omega_0 t)], \omega_0 t \in [\pi, 2\pi]. \quad (\text{A.8d})$$

It should be noted that instead of (A.7b), the following formula can be written

$$-\omega_0 t = \int_0^{j\varphi_{s-}} \frac{d(j\varphi/2)}{\cos(j\varphi/2)} \equiv j \int_0^{j\varphi_{s-}} \frac{d(\varphi/2)}{\text{ch}(\varphi/2)} = \ln \left| \text{tg} \left[- \left(\frac{\varphi_{s-}}{4} + \frac{\pi}{4} \right) \right] \right|, \text{ where } j = \sqrt{-1}.$$

The reversal of the last expression again leads to formula (A.8b); this is understandable, since the concave segment BA of the separatrix ABC indicates the finding of a separatrix on a pseudo-Riemannian surface (Fig. 4b).

The "reversal" operator denotes that we have a closed system in which the angle of rotation of the separatrix $\varphi_{s\pm}$ and its argument $\pm\omega_0 t$ are interdependent.

Let us now find out what connection exists between the solution (A.8a) and the sine-Gordon equation

$$\frac{\partial^2 \sigma}{\partial \xi \partial \tau} = \sin \sigma. \quad (\text{A.9})$$

The monograph [31] shows that the solution of equation (A.9) has the form

$$\sigma = 4\text{arctg}(\exp \sigma). \quad (\text{A.10})$$

Solution (A.8) for a point located on a separatrix, i.e. for $\omega_0 t = \varphi_{s+}$ coincides with the solution of the sine-Gordon equation (A.10), if we do not consider the constant π in solution (A.8).

It should be noted that equation

$$\frac{\partial^2 \sigma}{\partial \xi \partial \tau} = -\sin \sigma. \quad (\text{A.11})$$

This is not the sine-Gordon equation, as it is said in some monographs (see, for example, [9]), but it is the adjoint sine-Gordon equation. However, equations (A.9) and (A.11) are often written together

$$\frac{\partial^2 \sigma}{\partial \xi \partial \tau} = \pm \sin \sigma, \quad (\text{A.12})$$

referring the expression (A.12) as the sine-Gordon equation. The solution of equation (A.11) is written as follows

$$\sigma = -4\text{arctg}[\exp(-\sigma)]. \quad (\text{A.13})$$

It should be noted that the solution (A.13) reflects the motion along the concave segment BA (Fig. 4b) of the separatrix 3, i.e. the pseudo-Riemannian surface, and the solution (A.10) corresponds to a motion along the convex segment BC of the separatrix 3, i.e. over the Riemannian surface.

Since the solution of the sine-Gordon equation (A.9) is equivalent to the solution of the equation of the mathematical pendulum (A.8a) (without a free term π), and the expression (A.8a) is a solution of the Hamiltonian optimization equation (0.8a), the sine-Gordon equation (A.9) is optimal.

This means that there can be carried out a transition from the Hamilton equation (A.6) to the sine-Gordon equation (A.12). The reader is invited to make this transition.

Supplement B

Solutions of the equations of a mathematical pendulum.

Stochastic nature of the impulse of a mathematical pendulum

The joint representation of the equations of a mathematical pendulum (A.1) and (A.2) has the form:

$$\dot{p}^2 = \frac{g}{h}(1-p^2)\left(\frac{\nu}{2h} - p^2\right), \quad (\text{B.1})$$

where $\nu = 2hk^2$, $\frac{\nu}{h} = 1 + \frac{E}{F}$.

From these relations we have: $k_{\pm} \in \pm\left(\frac{F+E}{2F}\right)^{1/2}$. For $E = -F + \Delta E$ we have $k_{+} \in +(0\dots, k, \dots 1)$

and $k_{-} \in -(0\dots, k, \dots 1)$, where $k = \left(\frac{\Delta E}{2F}\right)^{1/2}$.

We consider separately two types of motion of the pendulum: oscillatory motion, when the point oscillates near the lowest position of the circle, and rotational motion, when the point is so fast that it constantly describes the complete circles.

1. In oscillatory motion, the point stops, not reaching the highest position of the circle; therefore, \dot{p} becomes zero for some value $p < 1$. Thus, in this case, $\nu / 2h = k_{\pm}^2 < 1$, where $k_{\pm} = \text{const}$ is the module of the elliptic Jacobi function, describes the relative energy (for $|k_{\pm}|$ or $|k_{\pm}|^{-1}$) of the mathematical pendulum.

To solve equation (B.1) in the class of elliptic Jacobi functions, it is necessary to represent equation (B.1) in the equivalent form

$$\dot{p}^2 = \frac{gk^2}{h}\left(1-k^2 \cdot \frac{p^2}{k^2}\right)\left(1-\frac{p^2}{k^2}\right).$$

The solution of the last equation is given by

$$p = k_{\pm} \operatorname{sn}\left[\sqrt{\frac{g}{h}}(t-t_0), k_{\pm}\right]. \quad (\text{B.2})$$

Expression (B.2) is a solution to the problem of the oscillatory motion of a mathematical pendulum. Constants of integration t_0 and k must be found from the initial conditions of motion. According to the well-known properties of Jacobi's elliptic function sn , formula (B.2) describes a motion that is periodic.

2a. In rotation of the pendulum, $\nu > 2h$. Consequently, assuming $2h = \nu k^2$, we will have $|k_{\pm}| < 1$ and $|k_{\pm}|^{-1} > 1$. In this case, the differential equation (B.1) takes the form

$$\dot{p}^2 = \frac{g}{hk^2}(1-p^2)(1-k^2p^2)$$

The solution of the last equation is written using the elliptic Jacobi function¹

$$p = \operatorname{sn}\left(\sqrt{\frac{g}{h}} \cdot \frac{t-t_0}{k_{\pm}}, k_{\pm}\right). \quad (\text{B.3})$$

2b. Finally, let $\nu = 2h$; the moving point of the pendulum reaches the highest position of the circle. In this case, the differential equation (B.1) is written as follows

$$\dot{p}^2 = \frac{g}{h}(1-p^2)^2$$

or

$$\dot{p} = \pm \sqrt{\frac{g}{h}}(1-p^2). \quad (\text{B.4})$$

The last expression represents two Riccati differential equations; their solutions are given by hyperbolic functions

$$p_{1,2} = \pm \operatorname{th}\left[\sqrt{\frac{g}{h}}(t-t_0)\right] = \pm \operatorname{th}(\varphi - \varphi_0) = \operatorname{th}\left[\pm(\varphi - \varphi_0)\right], \quad (\text{B.5})$$

where

$$\varphi = \omega_0 t, \quad \varphi_0 = \omega_0 t_0, \quad \omega_0 = \sqrt{\frac{g}{h}}.$$

Hyperbolic functions p_1 and p_2 , having opposite signs, show that the point of the pendulum can describe complete circles in opposite directions.

It should be noted that the solutions (B.2) and (B.3) of the pendulum equation (B.1) do not satisfy the Euler-Lagrange optimization equations (0.8a), (0.8b), although the equations of the mathematical pendulum (A.1) themselves satisfy Hamilton equations (A.3). To avoid this inconsistency in the solutions (B.2) and (B.3) it is necessary to assume $k = \pm 1$. In this case, the solutions of the pendulum equation (B.1) take the form of solutions of the Riccati equations that satisfy the Euler-Lagrange equations, (0.8a), (0.8b). Consequently, **if in decisions (B.2) and (B.3) we assume $k = \pm 1$, then we obtain solutions (B.5) of the Riccati equations (B.4);**

¹Jacobi function $\operatorname{sn}(t, k)$ has the property that for $k = \pm 1$ it becomes a hyperbolic tangent, i.e. $\operatorname{sn}(t, \pm 1) = \operatorname{th}(t)$.

in this case, the above inconsistency will disappear. As was shown in § 1.7, this behavior of the pendulum is equivalent to motion on the separatrix (see case 2b).

Finally, we show the stochastic nature of the momentum of a mathematical pendulum. To this end, we represent the two Riccati equations (B.4) separately:

$$\dot{p}_1 = \omega_0 - \omega_0 p_1^2, \quad (\text{B.4a})$$

$$\dot{p}_2 = -\omega_0 + \omega_0 p_2^2. \quad (\text{B.4b})$$

These equations correspond to the following observation systems (see formulas (0.1) and (0.2))

$$\begin{cases} \dot{x} = \xi(t), \\ y = x + \zeta(t), \end{cases} \quad (\text{B.4I})$$

$$\begin{cases} \dot{x}^* = \xi^*(t), \\ y^* = x^* + \zeta^*(t), \end{cases} \quad (\text{B.4II})$$

where $\xi(t)$ and $\zeta(t)$ uncorrelated real white Gaussian noises, while $\xi^*(t)$ and $\zeta^*(t)$ are also, they uncorrelated imaginary white Gaussian noise. These noises have the following stochastic characteristics:

$E[\xi(t)] = 0$ and $E[\xi^*(t)] = 0$, $E[\xi(t)\xi(t')] = \omega_0\delta(t-t')$, $E[\xi^*(t)\xi^*(t')] = -\omega_0\delta(t-t')$, $E[\zeta(t)\zeta(t')] = \omega_0^{-1}\delta(t-t')$, $E[\zeta^*(t)\zeta^*(t')] = -\omega_0^{-1}\delta(t-t')$, where E is the operator of mathematical expectation, δ is the Dirac function.

In the case of system (B.4I), the equation for the variance p_1 has the form (B.4a), and in the case of the system (B.4II), the equation determining the variance p_2 will be (B.4b).

Consequently, the impulses p_1 and p_2 , found according to the formula (B.5), are the variances of some observation systems. **The solutions of the equations of a mathematical pendulum, occurring as the solutions of the Riccati equations, determine dispersion and, consequently, are dissipative functions**

$$p_1 = \text{th}(\varphi - \varphi_0) \quad (\text{B.5a})$$

and

$$p_2 = -\text{th}(\varphi - \varphi_0). \quad (\text{B.5b})$$

In view of the fact that the function $\text{th}(\cdot)$ is odd, i.e. $-\text{th}(\omega) = \text{th}(-\omega)$, impulse-dispersion p_2 corresponds to such motion of the pendulum, which have the opposite direction, which takes place for impulse -dispersion p_1 (see Fig. 4b); the trajectory of these motions is below the axis 0φ .

The derivatives of formulas (B.5a) and (B.5b) on φ lead to known differential relations for hyperbolic functions

$$p_1' = \text{sech}^2(\varphi - \varphi_0), \quad (\text{B.6a})$$

$$p_2' = -\text{sech}^2(\varphi - \varphi_0). \quad (\text{B.6b})$$

Equations (B.6a) and (B.6b) are written for dispersion-pulses of a mathematical pendulum functioning in terrestrial conditions. For the pendulum functioning in the Universe, the structure of equations (B.6a) and (B.6b) remains the same, only the parameter ω is subject to change. In the case of the Universe, this parameter is determined by the formula

$$\omega_1 = \sqrt{\frac{|\gamma|}{h_1}} \equiv \sqrt{\frac{\alpha M}{h_1^3}} \text{ and consequently,}$$

$$\varphi_1 = \omega_1 t. \quad (\text{B.7})$$

In §2.4, the angle of deviation of the pendulum, functioning in terrestrial conditions, is everywhere replaced by the angle of deviation of the pendulum, functioning on the scale of the Universe.

If in the right-hand side parts of equations (2.19) and (2.20) we factor out the terms $\mu_+ z_+$ and $-\mu_- z_-$, we will have

$$\frac{dz_+}{dt} = \mu_+ z_+ (n_+ - z_+), \quad (\text{B.8a})$$

$$\frac{dz_-}{dt'} = -\mu_- z_- (n_- - z_-), \quad (\text{B.8b})$$

where $n_+ = \beta_+ / \mu_+$ and $n_- = \beta_- / \mu_-$; values β_+ , μ_+ and β_- , μ_- are defined by formulas (2.34) and (2.35). Equations (D.8a) and (D.8b) can be written as follows

$$\frac{dz_+}{dt} = \frac{1}{4} \mu_+ n_+^2 \text{sech}^2 \left[\frac{1}{2} \mu_+ n_+ (t - t_0) \right], \quad (\text{B.8c})$$

$$\frac{dz_-}{dt'} = -\frac{1}{4} \mu_- n_-^2 \text{sech}^2 \left[\frac{1}{2} \mu_- n_- (t' - t'_0) \right], \quad (\text{B.8d})$$

where the moment of "the creation of the world" is t_0 , and the beginning of the compression of the Universe is t'_0 . From equations (B.8c) and (B.8d) it is clear that for evolution of the Universe, the matter density satisfies differential equations having the same structure as impulse-dispersion (B.6a) and (B.6b).

The solution of equations (B.8a) and (B.8b) have the form:

$$z_+ = \frac{n_+}{1 + e^{-\mu_+ n_+ (t - t_0)}}, \quad (\text{B.8e})$$

$$z_- = -\frac{n_-}{1 + e^{\mu_- n_- (t' - t'_0)}}. \quad (\text{B.8f})$$

Supplement C

Model of the Big Bang in the Universe

By its nature, the results of this Supplement refer to a separate paragraph. However, in view of the large number of formulas, the author considered it possible to render the present material as a mathematical supplement.

In the "radiation era" the field density is determined by the formula

$$x = \frac{3}{32\pi\alpha t^2}, \quad (\text{C.1})$$

the time t is given in seconds.

The density of matter in the Universe is determined by the expression (2.32a) $z =$

$$z_0 e^{(a - \frac{bcz_0}{a}e)t}, \quad (\text{C.2})$$

where the parameters a, b, c, d satisfy "predator - prey" systems M (see page 50) and N (z_0 definitely on the page 53). Since in the early moments of time the strong inequality must hold

$$a \gg \frac{bcz_0}{d} e,$$

instead of the expression (C.2), we obtain a simplified formula

$$z = z_0 e^{at}. \quad (\text{C.3})$$

Since in the early moments of time after the Big Bang the field made a much larger contribution to the matter density than the substance, the weight coefficient b in the first equation of the system M is approximately equal to zero, i.e. $b \approx 0$. Proceeding from this, the first equation of the system M will take the form:

$$\frac{dx}{dt} = ax.$$

The solution of the last equation is written as $\ln x = a \int_0^t dt$.

If in the last equation we take into account x according to (C.1), we will have

$$at = \ln K - \ln t^2, \quad (\text{C.4})$$

where $K = \frac{3}{32\pi\alpha}$.

In formula (C.3), substitution of value at found from (C.4), will give

$$z = z_0 e^{\ln K} \cdot e^{-\ln t^2}$$

The volume occupied by matter in the Universe during the Big Bang is

$$V = V_0 e^{\ln t^2} \tag{C.5}$$

where

$$V_0 = \frac{M^*}{z_0 e^{\ln K}} = \text{const.}$$

Formula (C.5) shows that as a result of the Big Bang the volume of matter in the Universe grows exponentially – logarithmic; it adequately reflects the exponential expansion of the Universe that occurs during the Big Bang. On the basis of physical considerations, in the formula (C.5), the current time t must satisfy the initial condition $t_0 = 1$.

In the course of time, the contribution of the density of matter to the density of matter increases. In quantitative terms, this increase is appropriately reflected by an increase of the value of coefficient b in the first equation of the system M . In addition, the process of expansion of the Universe slows down, because the difference $a - \frac{bcz_0}{d} e$ decreases. Such development of scenario is actually observed.

Considerations

On the expediency of application of the model of a mathematical pendulum (from the point of view of GTR) in modeling the Megaworld evolution considering the relationship between space, time and matter

As noted in Supplement A, the pendulum parameter ω_0 should be considered together with the current time. However, the parameter ω_1 is distributed in space, as evidenced by the dependence of the parameter ω_1 on the mass M and the length h_1 of the pendulum, i.e.

$$\omega_1 = \sqrt{\frac{\alpha M}{h_1^3}}. \text{ This means that the equations of the pendulum establish a relationship between}$$

matter, space and time. Acceleration γ also depends on the length h_1 (see page 46) of the pendulum. Therefore, the relationship between ω_1 , t and the space already exists, because mass M is distributed in space.

Conclusion

There is not a universal theory for the discrete objects of the physical Microworld and therefore, naturally, investigation are based on the study of particular cases. In the process of searching for a theory that would characterize all the discrete objects of the physical Microworld, the author found out what unites the discrete objects of the physical Microworld and also found out what the physical Microworld and Megaworld make similar. Such a common factor was found to be the optimality of the objects in the physical Microworld and Megaworld. The optimality of the physical Microworld and Megaworld allowed us to look at how these worlds are organized, from a new, optimization position.

In examining the optimality of the physical Microworld, some new physical properties inherent to this world were revealed. Thus, for example (see §1.1), in transition to the discrete analogue of the Schrödinger equation, it was found that for solution of the discrete analogue of the Schrödinger equation, an electric field gradient can be determined, where the elementary particles are "born out of nothing". § 1.2 defines the relation between the knots and binary functions, and also there is received a relation between the number of knots having the same number of intersections and the optimal frequencies on which the knots are formed in binary systems. From the standpoint of physics, a lot of flattering words have been expressed about the distribution of Fermi-Dirac gas. Unfortunately, no laudatory words were found in the address of the optimizing property of this distribution. Therefore, in § 1.3 we have proved the optimality of this gas from the point of view of its Lagrangian satisfying the Euler-Lagrange equation. Although the models of fixed and moving atoms are well known, up to now, no attention has been paid to the optimal property of these models. In order to remove this drawback in §1.5 and §1.6 it is proved that models of stationary and moving atoms have optimal properties; The atoms in these models are located and move along the separatrix of the mathematical pendulum. §1.7. is of particular value. It gives an alternative approach to the problem of GTR, based on the optimal separatrix property of a mathematical pendulum. This approach is a new word in this field of science, since instead of the extreme property of the geodesic line, it uses the optimal separatrix property of the mathematical pendulum and, consequently, solves the GTR problem in a closed form, when this problem is solved by using a finite number of computations.

After putting the “Hubble” and “Kepler” telescopes into near-Earth orbit, it became known that the amount of matter in the Universe is able to stop the expansion of the Universe. This fact had a significant impact on the problems of cosmology. A dark matter constitutes the overwhelming part of matter that is in the Universe. The model for the formation of a dark

matter is given in §2.1. It is based on the use of the Gibbs thermodynamic potential and attests to the important role played by optimality in the formation of matter in the Universe. The model of expansion and contraction of the Universe is proposed in §2.2; it is entirely based on the equations of a mathematical pendulum satisfying the Hamilton equation. The physical preconditions for the evolution of the Universe are given in §2.3. They are based on the Lotka–Volterra "predator-prey" model, which plays an important role in the modeling of competitive processes. This model satisfies the Euler-Lagrange equation, i.e. it is optimal. In §2.4, based on the use of the elliptic Jacobi function, solutions are given to the equations for the separatrix, the vibrational and rotational motions of the mathematical pendulum. In this paragraph we determine the volume of the ellipsoid and show how to calculate the separatrix surface in the Universe. In the last point of this paragraph, we propose a new approach to determining the curvature of the Universe. All the points in this paragraph are in some way connected with the functioning of the mathematical pendulum, i.e. the results presented in them are optimal. The use of the results of Holzmark, when modeling a mathematical pendulum on the scale of the Galaxy, is devoted to §2.6. In §2.5 and §2.7 hypothetical models of the formation of an elliptical Galaxy and the emission of a luminous matter from the nucleus of the Galaxy are proposed.

The model of the Big Bang of the Universe given in Supplement C is very important. The hyperextension of the Universe, taking place at the initial moments of the "Creation of the World", is adequately modeled by using Lotka–Volterra "predator-prey" models. Thus, the expediency of applying the proposed Big Bang model to simulate the evolution of the Universe is confirmed.

Thus, the task set before the present monograph is achieved: the new models of the Microworld and Megaworld are obtained, and their optimality is proved.

The above results concern the inanimate Megaworld (the Universe). It should be noted, however, that there are star systems in Galaxies that have planets on which life, like our planet, can arise. The development of life on our planet is eloquently described in the monograph [2]: "Random genetic changes – accidents - generate an arbitrary set of possibilities, from which nature selects only that what gives the body an advantage in its continuous struggle for survival. Only by looking through an extremely wide range of possible changes does the body find an option that accidentally finds an option that facilitates its adaptation in the environment". This statement does not use the term "optimization", although this term is invisibly present in this quote (optimization by means of random search). At the early stage of the emergence of the living, the same thought sounds in the text of the monograph [32]: "Evolution is a procedure for further *optimization* in the presence of certain superposable restrictions by the selection criteria."

Beginning with the early stages of the birth of human communities to the present day, the term "optimization" has not lost its relevance, rather it has acquired new spheres of its application, since all inanimate and living (including reasonable) is created and evolves on the basis of principles of optimality.

It is amazing that in the living and inanimate nature the same optimization equations are functioning. This explanation is understandable, since there is no sharp line between living and non-living. This is evidenced by viruses simultaneously related to both living and non-living nature.

REFERENCE

1. Брайсон А., Хо ю-ши. Прикладная теория оптимального управления. М.: Мир, 1972.
2. Девис П. Суперсила. М.: Мир, 1989.
3. Ахиезер Н.И. Лекции по вариационному исчислению. М.: Гостехиздат, 1955.
4. Мдзинаришвили В.В. Переход к дискретному аналогу уравнения Шрёдингера и его решение. Тбилиси, INTELECTI, №2(52), 2015.
5. Мдзинаришвили В.В. Новые аспекты современной теории самоорганизующихся и организующихся систем. Тбилиси: Издательство Национальной Академии наук Грузии, 2014.
6. Мдзинаришвили В.В. Выражение квантовомеханических функций через значения бинарной функции и их связь с узлами. Седьмая международная научная конференция «Образование, экономика и устойчивое развитие». 28-29 ноября 2014 года, г. Гори.
7. Метьюс П. Релятивистская квантовая теория взаимодействия элементарных частиц. М.: ИЛ, 1959.
8. Четаев Н.Г. Теоретическая механика. М.: Наука, 1987.
9. Лэм Дж. Мл. Введение в теорию солитонов. М.: Мир., 1983.
10. Мдзинаришвили В.В. Современная интерпретация теории относительности. Тбилиси, INTELECTI, №3(53), 2015.
11. Schwarzschild K. Berlines Berichten, 189, 1916.
12. Уилер Дж. А. Предвидение Эйнштейна. М.: Мир, 1970.
13. Мари-Антуанет Тоннела. Основы электромагнетизма и теории относительности. М.: ИЛ, 1962.
14. Пиблс Ф.Дж. Э. Структура Вселенной в больших масштабах. М.: Мир, 1983.
15. Зельдович Я.Б. Теория расширяющейся Вселенной, создания А.А. Фридманом. В книге А.А. Фридман. Избранные труды. М.: Наука, 1966.
16. Борн М. Эйнштейновская теория относительности. М.: Мир, 1964.
17. Parker L. The Birth of the particle in the expansible Universe. Physical Review Letters v.21, No.8, p. 562, 1968.
18. Дубровский В.А. Упругая модель физического вакуума // ДАН СССР, т. 282, №1, с.83, 1985.
19. Новацкий В. Теория упругости. М.: Мир, 1975.

20. Эшелби Дж. Континуальная теория дислокаций. М.: Мир, 1963.
21. Радужкевич Л.В. Курс термодинамики. М.: Просвещение, 1971.
22. Мдзинаришвили В.В. Модель расширения и сжатия Вселенной с отрицательной кривизной. Тбилиси, INTELECTI, №1(54), 2016.
23. Брон О.Б. Электромагнитное поле как вид материи. М.: Госэнергоиздат, 1962.
24. Романовский Ю.М., Степанова Н.В., Чернавский Д.С. Математическое моделирование в биофизике. М.: Наука, 1975.
25. Мдзинаришвили В.В., Самхарадзе З.П. О совместном существовании антагонистических популяций. Пятая международная конференция «Образование и инновация». 16-18 ноября 2012, Гори.
26. Новиков И.Д. Как взорвалась Вселенная. М.: Наука, 1988.
27. Shaw R. Zeitschrift Naturforsch, v.36a, p.80, 1981.
28. Чандрасекар С. Стохастические проблемы в физике и астрономии. М.: ИЛ, 1947.
29. Holzmak J. Annalen der Physik 58, 577, 1919.
30. Уитни Ч. Открытие нашей Галактики. М.: Мир, 1975.
31. Позняк Э.Г., Шикин Е.В. Дифференциальная геометрия. Первое знакомство. М.: Московский университет, 1990.
32. Эйген М. Самоорганизация материи и эволюция биологических макромолекул. М.: Мир, 1973.

Contents

Introduction.....	4
CHAPTER 1. New models of physical Microworld and their optimality.....	9
§1.1. Transition to discrete analysis of the Schrödinger equation and inverse problem solution.....	9
§1.2. Knots and binary functions. Optimum frequencies at which binary functions are formed	16
§ 1.3. The optimality characteristic of a Fermi-Dirac gas	23
§ 1.4. Consideration of the Maxwell equations on the mesoscopic level	26
§1.5. The optimality of the model of stationary atoms	28
§ 1.6. The optimality model of moving atoms	29
§1.7. Modern interpretation of the general theory of relativity (GTR)	31
CHAPTER 2. New Models of Megaworld and their optimality.....	41
§2.1. A possible model for the formation of a dark matter in the Universe	41
§2.2. Dynamic model of expansion and compression of the Universe	47
§2.3. The physical prerequisites for the expansion and compression of the Universe.....	49
§2.4. The solution of the equations of the pendulum functioning in the Universe for separatrix, vibrational and rotational motions. The determination of the volume corresponding to the oscillatory motion of the pendulum of the Universe. Determination of a separatrix surface in the Universe. Curvature of the Universe	55
§2.5. Hypothetical model of the formation of an elliptical Galaxy	61
§2.6. Using the equations of a mathematical pendulum formodeling the star systems for Galaxy	66
§2.7. Hypothetical model explaining the emission of luminous matters from the nucleus of the Galaxy	68
Supplement A	70
Supplement B	74
Supplement C	79
Conclusion	81
REFERENCE	84

V.V Mdzinarishvili

New Models of Physical Microworld and Megaworld

Optimality models of physical Microworld and Megaworld

Georgian National Academy of Science publishing House

Tbilisi

2019

Readership: Specialists of the Physical Microworld, Astrophysics and Cosmology

The book: comprises two chapters. First chapter is devoted to the Physical Microworld. Here is discussed the new mathematical models of the Physical Microworld. The new interpretation of the relativity theory takes the important part in this chapter, which belongs to the author.

The Second chapter is devoted to Cosmology and Astrophysics, where the mathematical models of formation of the dark matter are proposed. Also, the dynamic and physical models of the Universe evolution are presented based on the mathematical pendulum model. In this chapter the author also offers the defining rule of the Universe curvature. The Big Bang Model is discussed in the second chapter as well.

The author: Valentin V. Mdzinarishvili, Doctor of Science of System Theory, Automatic Control and Regulations and System Analysis. Professor, Department of Mathematics.

V. V. Mdzinarishvili

**NEW MODELS OF PHYSICAL
MICROWORLD AND MEGAWORLD**

**OPTIMALITY MODELS OF PHYSICAL
MICROWORLD AND MEGAWORLD**

Tbilisi

Georgian National Academy of Sciences

2019