

Typological Characteristics of Working Memory in Vascular Dementia

Kate Inasaridze

Tbilisi - 2006

Georgian State Medical Academy

with the right of a MS

Typological Characteristics of Working Memory in Vascular Dementia

by

Kate Inasaridze

Thesis submitted to the I. Beritashvili Institute of Physiology for the degree of Candidate of
Biological Sciences.

03.00.14 – Fundamental Neurosciences

Tbilisi - 2006

Dedicated

to

my parents Hvedri and Tsisana and my lovely daughter Sophia

Table of contents

REVIEW SECTION

1.	The working memory model	Pag. 1
1.1.	The phonological loop	Pag. 4
1.2.	The visuo-spatial sketchpad	Pag. 6
1.3.	The central executive	Pag. 11
1.3.1.	The dual-task methodology	Pag. 14
1.4.	Neuroanatomical basis of working memory	Pag. 14
2.	Vascular Dementia	Pag. 15
2.1.	The concept of Vascular Dementia	Pag. 15
2.2.	Epidemiology	Pag. 19
2.2.1.	Prevalence	Pag. 19
2.2.2.	Incidence	Pag. 21
2.3.	Risk Factors	Pag. 22

2.4.	Diagnostic criteria	Pag. 23
2.5.	Subtypes of vascular dementia	Pag. 25
2.6.	Pathological mechanisms	Pag. 28
2.6.1.	Volume of brain destruction	Pag. 28
2.6.2.	Location of vascular lesions	Pag. 29
2.6.3.	Number of cerebral vascular lesions	Pag. 30
2.7.	Neuropathology	Pag. 31
2.8.	Neuropsychology	Pag. 31
3.	Episodic memory	Pag. 33
3.1.	Concept of episodic memory	Pag. 33
3.2.	Neuroanatomy of episodic memory	Pag. 35
3.3.	Episodic memory in normal aging and dementia	Pag. 36
4.	Working Memory Span	Pag. 37
5.	Computerised version of the dual-task in AD patients	Pag. 39
5.1.	Effect of normal aging on dual-task performance	Pag. 47
6.	Paper and pencil version of the dual-task in AD patients	Pag. 48
6.1.	Combined dual-task <i>mu</i> score	Pag. 50
7.	Standing of research problem	Pag. 51
8.	Objectives of the study	Pag. 52
9.	Tasks of the study	Pag. 53

EXPERIMENTAL SECTION

10.	Methods and participants	
10.1.	The tasks used in the present study	Pag. 55
10.1.1.	The computerized version of the dual-task	Pag. 55
10.1.2.	The paper and pencil version of the dual-task	Pag. 56
10.1.3.	The pilot study	Pag. 57
10.1.4.	The “Tbilisi paper and pencil motor task”	Pag. 58
10.1.5.	Memory tasks	Pag. 59
10.1.5.1.	The working memory span task	Pag. 59
10.1.5.2.	The episodic memory tasks	Pag. 59
10.1.5.2.1.	The Verbal Paired Associates task	Pag. 59
10.1.5.2.2.	The Word Lists Learning task	Pag. 60
10.2.	Participants	Pag. 61
10.3.	Procedures	Pag. 62
11.	Experiment 1. An Age effect on Dual-Task	
11.1.	Aims	Pag. 63
11.2.	Methods	Pag. 64
11.3.	Results	Pag. 65
11.3.1.	The computerised version of the dual-task	Pag. 65
11.3.2.	The paper and pencil version of the dual-task	Pag. 70
11.3.3.	The correlation of the test-retest and of the computerised - paper and pencil versions of the dual-task	Pag. 73
11.3.4.	The norms for the <i>mu</i> scores	Pag. 78

11.4.	Discussion	Pag. 80
12.	Experiment 2. The effect of Vascular Dementia on Dual-Task	
12.1.	Aims	Pag. 82
12.2.	Methods	Pag. 82
12.3.	Results	Pag. 83
12.3.1.	The dual-task performance by VaD patients, age and education matched healthy elderly and education matched young participants	Pag. 83
12.3.1.1.	The computerised version of the dual-task	Pag. 83
12.3.1.2.	The paper and pencil version of the dual-task	Pag. 88
12.3.2.	The dual-task performance by VaD patients and age and education matched healthy elderly participants	Pag. 92
12.3.2.1.	The computerised version of the dual-task	Pag. 92
12.3.2.2.	The paper and pencil version of the dual-task	Pag. 96
12.3.3.	The correlation of the test-retest and of the computerised – paper and pencil versions of the dual-task	Pag. 100
12.4.	Discussion	Pag. 106
13.	Experiment 3. Dual-task and Memory Performance of VaD	
13.1.	Aims	Pag. 109
13.2.	Methods	Pag. 110
13.3.	Results	Pag. 111
13.3.1.	The dual-task and episodic memory	Pag. 111
13.3.1.1.	Performance of the VaD patients, age and education matched healthy elderly and education matched young participants	Pag. 111
13.3.1.2.	Performance of the VaD patients and age and education matched healthy elderly participants	Pag. 117
13.3.1.3.	Correlation of dual-task and episodic memory performance	Pag. 119
13.3.2.	Dual-task and working memory span	Pag. 123
13.3.2.1.	Performance of VaD patients, age and education matched healthy elderly and education matched young participants	Pag. 123
13.3.2.2.	Performance of VaD patients and age and education matched healthy elderly participants	Pag. 124
13.3.2.3.	Correlation of the dual-task performance and working memory span	Pag. 125
13.3.3.	Norms of the memory performance	Pag. 126
13.4.	Discussion	Pag. 142
14.	Conclusions	Pag. 144
15.	References	Pag. 146
16.	Acknowledgments	Pag. 156
17.	Appendix	Pag. 157

1. The working memory model.

Working memory is an important construct of modern cognitive neuropsychology (Logie & Della Sala, 2001). Working memory plays an essential role in complex cognition. Everyday cognitive tasks – such as reading a newspaper article, calculating the appropriate amount to tip in a supermarket or restaurant, mentally rearranging furniture in one’s living room to create space for a new sofa, and comparing and contrasting various attributes of different apartments to decide which to rent – often involve multiple steps with intermediate results that need to be kept in mind temporarily to accomplish the task at hand successfully. “Working memory” is the theoretical construct that has come to be used in cognitive psychology to refer to the system or mechanisms underlying the maintenance of task-relevant information during the performance of a cognitive task. As reflected by the fact that it has been labeled “the hub of cognition” and proclaimed as “perhaps the most significant achievement of human mental evolution”, it is a central construct in cognitive psychology and, more recently, cognitive neuroscience (Miyake & Shah, 1999).

The term *working memory* is used in quite different sense by different communities of researchers. In the behavioural neuroscience and animal behaviour field working memory has a specific operational definition different from that generally used by cognitive psychologists: “the ability of an animal to keep track of its location in space by remembering where it has been”.

The confusion remains even within the discipline of cognitive psychology. There is not always a clear-cut distinction between working memory and a concept of “short-term memory” (STM) revealing the internal inconsistency in discussion of the distinction of these two concepts. Some researchers suggested that STM and working memory are equivalent (Miyake & Shah, 1999). It is probably true that working memory as a concept has largely replaced the more traditional concept of STM. However, the concepts differ in important ways. STM typically refers to passive storage of small amounts of information on a temporary basis. In the case of verbal STM, an example would be retaining a telephone number long enough to make the call. In the case of visual STM, this might involve returning to the correct position on the page after reading has been interrupted. In contrast, working memory refers to both passive, temporary storage of visual and verbal information and the active mental manipulation of that information. In this sense, working memory incorporates STM among its functions.

A number of different metaphors are used to reflect working memory and to highlight different characteristics of the concept, including the “box” or “place” metaphor, the “workplace”

or “blackboard” metaphor, the “mental energy” or “resources metaphor”, and the “juggling” metaphor.

Some working memory theorists emphasize the unitary nature of working memory, whereas others focus on its non-unitary nature (Miyake & Shah, 1999).

The present study relies on Baddeley’s working memory model since this model is derived empirically from studies of healthy adults and children and brain-damaged individuals. It provides a good explanation and organization of the normal and pathological empirical data. The model offers a useful framework to account for a wide range of empirical findings on working memory.

According to this model working memory comprises multiple specialized components of cognition that allow humans to comprehend and mentally represent their immediate environment, to retain information about their immediate past experience, to support the acquisition of new knowledge, to solve problems, and to formulate, relate, and act on current goals. These specialized components include both a supervisory system (the central executive) and specialized temporary memory systems, including a phonologically based store (the phonological loop) and a visuospatial store (the visuospatial sketchpad).

The two specialized, temporary memory systems are used to actively maintain memory traces that overlap with those involved in perception via rehearsal mechanisms involved in speech production for the phonological loop and, possibly, preparations for action or image generation for the visuospatial sketchpad. The central executive is involved in the control and regulation of the working memory system. It is considered to carry out various executive functions, such as coordinating the two slave systems, focusing and switching attention, and activating representations within long-term memory, but it is not involved in temporary storage. The central executive is conceptualized as working memory component, which serves to organize and control action, is engaged in the retrieval of categories, procedures, and so on from longer-term memory, and allows the slave systems to communicate with each other, whilst also acting as a general decision, planning and scheduling mechanism. The central executive in principle may not be a unitary construct, and this issue is a main focus of current research within this framework.

Working memory refers to aspects of on-line cognition – the moment-to-moment monitoring, processing, and maintenance of information both in laboratory tasks and in everyday cognition. The existence of the multiple specialized subcomponents of cognition, that comprising working memory is considered an empirical question, rather than something that forms an a priori assumption of the model.

The original model proposed by Baddeley and Hitch (1974), shown schematically in Figure 1., comprises a *central executive* controlling mechanism and two subsidiary or “slave” systems, called the *phonological loop* and the *visuospatial sketchpad*, which are specialized for the processing and temporary maintenance of material within a particular domain (i.e. verbally coded information and visual and/or spatial information, respectively) (Della Sala & Logie, 2002).

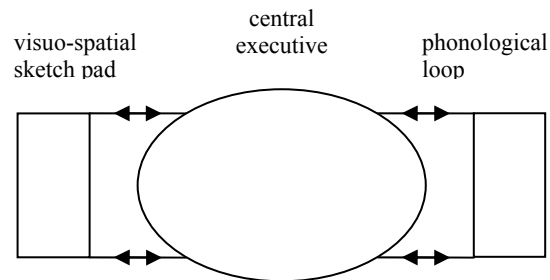

Figure 1. Working memory model.

The suitable candidate for the central executive, suggested by Baddeley (1986), is the attentional control model proposed by Norman and Shallice (1980). According to the Norman and Shallice model it is assumed that behaviour is controlled at two levels. The first involves a series of ongoing programmes or schemata that typically run in parallel, with contention scheduling procedures available to resolve conflicts. However, such programmes can be initiated, terminated or modified by a higher-level Supervisory Activating System (SAS), which is necessary for initiating new behaviour, for making changes in ongoing activity and for resolving major conflicts that may occur in the concurrent performance of two or more activities. It is suggested that such a system can be defective in the case of normal aging, damage to the frontal lobes and dementia, all of which affect the Central Executive in different ways (Baddeley, 1986).

The working memory framework grew, in part, from the problems the modal model had in accounting for the serial position curve, different duration and capacity estimates for short-term memory, a dependence on phonological coding, and patients with patterns of deficits which run counter to what would be expected from the modal model. To a greater or lesser extent, each of these difficulties are solved or circumvented by the working memory framework. These solutions partly depend on its inherent complexity. The different estimates of capacity and duration, which appeared to conflict, are seen as reflecting the capacities and durations of different aspects of working memory, and especially of different components of the system operating in concert. Serial position effects arise in part as an interaction between the sequential encoding facilitated by the phonological loop, but also as the result of more general retrieval strategies controlled by the central executive. Coding differences are easily supported by the range of components within working

memory. Also it not only serves better to describe the range of difficulties which patients like H.M. and K.F. experienced, but also a wide range of other combinations of deficit (Groeger, 1997).

Thus, for example, amnesic patients with hippocampal formation damage were shown, in extensive tests of their transitory memory abilities, to have normal short-term memory functioning despite having severely impaired long-term memory abilities. This supports the conclusions suggested that transitory acquisition and retrieval is independent of the formation and retrieval of more enduring memories. However, this relationship is not transitive. Evidence from K.F. was originally thought to show that because he was capable of longer term learning, in spite of the fact that his digit span was severely limited, longer-term learning must be possible without access to short-term memory. Because of the reconceptualisation of short-term memory in terms of multiple stores, such as Baddeley's working memory framework, there is no need for impaired digit span to lead to a complete absence of long-term learning. This was neatly demonstrated by work with a patient (P.V.) who had suffered a cardiovascular accident involving the left perisylvian region. Just like K.F., this patient had a very poor digit span (2 items), but it was also clear that she was quite capable of long-term learning (Groeger, 1997). However, when tests were devised which required her to use phonological coding of the material, rather than some other route, this capacity for long-term learning disappeared.

1.1. The phonological loop

As mentioned above, the phonological loop is composed of two sub-systems, a phonological store which passively holds speech-based information, for one and a half to two seconds before it decays, and an articulatory control process which allows (a) sub-vocal rehearsal of the contents of the passive store, thus preventing decay, and (b) intake of written material and its conversion into a phonological code (i.e. representing it as a sound), thus registering it in the passive phonological store. The effect of the articulatory control process is normally observed through the imposition of *articulatory suppression*, that is, when the subject, in addition to performing the immediate memory task, is prevented from using articulatory mechanisms by having to repeat sounds, whether these are meaningful or meaningless (e.g. the-the-the- etc.).

One source of evidence for the speech-based nature of the phonological store and the role of the active rehearsal process is the *phonological similarity effect*, which shows that subjects find it more difficult to remember a sequence of phonologically similar items as PGTVCD than phonologically different items RHXKWY. Baddeley suggested that the effect arises because such stimuli are confusable within the phonological store, leading to poorer recall. Articulatory suppression removes the phonological similarity effect when the items to be remembered are

presented visually. Thus two strings would be equally memorable, because articulatory suppression prevents the visual code being converted into a phonological code, the subject being forced to rely on the visual properties of the consonant strings. When consonant strings are heard rather than seen, no visual to acoustic recoding is required, and thus where the elements of strings are highly confusable, articulatory suppression does not remove the phonological similarity effect. It is presumed that this is because auditory material has direct access to the phonological store (Groeger, 1997). The articulatory suppression would not be expected to make performance worse with auditory presentation unless the items used for suppression and the information to be remembered are phonologically similar.

A second effect, which testifies to the speech-like nature of the phonological store, is the *unattended speech effect*. The effect shows that immediate recall of visually presented words or digits is impaired if the visual presentation is accompanied by irrelevant spoken material, even when subjects were told that the spoken material was irrelevant. Similar level of disruption occurred irrespective of whether the spoken materials were words or nonsense syllables. A subsequent study showed that "unattended" digits and sounds, which sounded like digits, interfere to a similar extent when digits were presented visually. This was taken to indicate that phonological storage is not at the level of words, and was originally taken to suggest that phonemes, or perhaps the articulatory commands required to produce these sounds, reflected the type of storage in the phonological store. The noise, given a speech-like rhythm by adding or omitting pulses, does not give rise to the unattended speech effect, but that music with voices does, as does instrumental music, irrespective of whether it was classical or modern (Groeger, 1997).

The third effect of note is the *word-length effect*. Baddeley and colleagues showed that the time taken to read words aloud and the successful immediate recall of words are closely related. A subsequent study indicates that memory span represents the number of items that can be uttered in about two seconds. For example, it was measured relations between reading time and memory span in English, Spanish, Hebrew, and Arabic. Reading rate was measured either in speeded reading of digits or in normal-pace reading of stories. Faster speeded and normal-paced reading rates for a language were associated with larger memory span for speakers of that language (Groeger, 1997). It was shown that when articulation is suppressed during encoding and retrieval, the word-length effect is effectively abolished. As was mentioned above the speech-like nature of the encoding is rather questionable (Groeger, 1997).

Della Sala & Logie (1997) showed that minority of normal subjects fail to show the effects of phonological similarity and of word length effects with visual and auditory presentation. These

effects, especially those for word length, had a poor test-retest reliability that could be due in a large part, to shifts in strategy choice by subjects and to poor memory span.

1.2. Visuo-spatial sketch pad

Contemporary thinking on the concept of short-term memory has been influenced heavily by the assumption that temporary memory has evolved to support language. Indeed the term “short-term memory” has, until recently, been used to refer solely to verbal temporary storage. Neuropsychological reports and experimental studies with healthy adults revealed that temporary retention and manipulation of visual and spatial information is supported by cognitive functions that are dissociable from verbal short-term memory. In the case of patients with verbal short-term memory deficits, their memory span for visually presented verbal sequences is much higher than their pathological span for articulatory presented sequences. This is the converse of the pattern for healthy adults, who typically show higher spans for aurally presented than for visually presented verbal sequences (Della Sala & Logie, 2002).

The independence of verbal and visual short-term memory has been demonstrated further using interference paradigms with healthy adults, was shown that retaining visuospatial images was disrupted when combined with performing a concurrent perceptuo-motor tracking task. However Baddeley et al. (1986) reported that perceptuo-motor tracking had a minimal impact on concurrent performance with auditory verbal span. In contrast, serial verbal memory span is dramatically disrupted by concurrent generation of an irrelevant, repeated spoken output (articulatory suppression), whereas articulatory suppression has no impact on a visuospatial manipulation task. These double dissociations were demonstrated within the same studies which suggests distinction of visuospatial and verbal short-term memory systems. In healthy adults was shown that performing mental arithmetic disrupted performance on an immediate letter memory task, but had little impact on immediate memory for visuospatial material. In a contrasting condition, a concurrent imagery task interfered with retention of a matrix pattern but had little effect on retention of random letter sequences. In a study of a group of Alzheimer patients, was reported a clear double dissociation, where some patients showed pathological performance on verbal immediate memory span, but normal performance on memory for a sequence of targeted movements. Other patients in the same group showed the converse, with very poor Corsi block performance coupled with normal immediate verbal memory span.

Nature of the visuospatial working memory can be revealed from studying patients with neglect (Della Sala et al., 2004). Neglect is not confined to impairments in reporting details of

extrapersonal space. It can also be demonstrated as an impairment of the mental representation of a scene, either recently perceived or drawn from more remote past experience. A number of patients who have been reported with perceptual neglect also present with representational neglect, in which only half of the scene represented in a visual image can be reported and this is not simply because of a general memory problem. It was suggested that this pattern of impairments might reflect a deficit in the visuospatial system within working memory; and that the perceptual system and the representational system can cooperate, but are not as intimately related as is often assumed (Baddeley et al., 2002).

There are a number of reports of patients who present with a representational deficit in the absence of any impairment in perceiving extrapersonal space. These are in striking contrast to patients who show clear evidence of perceptual neglect in the absence of any difficulty in generating mental representations and in reporting, from memory, representations of familiar scenes or objects or reporting details of recently formed mental representations derived from verbal descriptions of object layouts (Baddeley et al., 2002). These contrasting cases present a double dissociation between damage to a visual perceptual system and damage to a visuospatial representational system, indicating that these comprise dissociable systems in the healthy brain. This suggests further that the systems cannot be interdependent, as is suggested by the gateway hypothesis. Where the visuospatial representational system is the primary means for initial processing of sensory input, then damage to the representational system might be expected to result in impairments of visual perception. Therefore, the fact, that representational neglect can occur in the absence of perceptual neglect, and vice versa, presents a significant challenge for the suggestion that visual perception overlaps substantially with mental representation, as well as for the gateway hypothesis. However, it can be accommodated fairly comfortably with the model of working memory as a workspace by assuming that patients with pure perceptual neglect suffer from impaired activation of the knowledge base from sensory input in their neglected hemifield but have unimpaired access from working memory to previously stored knowledge. Patients with pure representational neglect have intact activation of stored knowledge resulting from sensory input, allowing successful object identification or interpretation of a scene. However, because of damage to the part of the system that allows interaction between the knowledge base and working memory, their ability to retain or manipulate information in the absence of sensory input is impaired. The perceptual system and the representational system can cooperate, but are not as intimately related as is often assumed.

The phenomena linked with representational neglect appear very similar to those reported in case of “hemi-amnesia” following experimental lesions in monkeys, and following parietal removal

in patients of the medial temporal lobe on the left or the right hemisphere. The animals and patients appear to have no difficulty with perceiving and identifying objects. However, following presentation and removal of a complex scene, the animals or patients do not appear to remember the half of the scene, which is contralateral to the lesion. That is, it appears that visuo-spatial working memory can be impaired for “half scenes”, and further suggests that the mental representation in the healthy brain might be constructed as two mental “hemifields”, which are normally experienced as a continuous image. A possible caveat that might arise from basing an argument on neglect and associated disorders is that the impairments are lateralized, with only part of the visual field or of the mental representation disrupted. However, dissociations also arise in patients for whom the damage is bilateral, e.g. Madame D. was severely impaired in identifying visually presented objects, regardless of the visual hemifield, but showed no difficulty in a range of task that required visual imagery derived from previously stored knowledge. This pattern contrasts sharply with the pattern of impairment and sparing in patient E.P., who had no difficulty in identifying objects in her visual field, but was unable to undertake any form of mental processing on images in the absence of perceptual input (Baddeley et al., 2002).

As has been indicated, visuospatial working memory is best viewed as an active workplace, rather than a passive memory store, which is somewhat distanced from perceptual processes. A range of patient data speak to the notion that visual and spatial working memory might be seen as two distinct but linked components of the cognitive system. **“Visual”** can be referred to as the visual appearance of an object or scene, its color, shape, contrast, size, visual texture and the location of objects relative to one another with respect to a particular viewpoint in a static array. **“Spatial”** can refer to pathways or sequences of movements from one location to another in the scene, or the processes of change in the perceived relative locations of objects that occur when an observer moves (physically or in a mental image) from one viewpoint to another. There is an ambiguity in the literature as to the use of the word “spatial”, which sometimes is used to refer to relative locations or layouts of objects. It is more useful to think of the “spatial” as referring to the dynamic properties of a scene or representation (Baddeley et al., 2002). The idea that visual and spatial working memory comprises dissociable components of the cognitive system has been supported by a range of studies of healthy participants (Della Sala et al., 1999; Gyselinck et al., 2000). For example, in healthy adults visual immediate memory tasks appear to be sensitive to disruption by secondary tasks different from those that disrupt immediate memory for movement sequences (Baddeley et al., 2002).

There are several problems with the apparently compelling link between the cognitive functions of visuospatial working memory and the neuroanatomical pathways associated with the

“what” and the “where” of visual perception. One difficulty arises from the fact that the visual/location/movement distinction within working memory applies to the representation held and manipulated within working memory. It does not refer to the processes of perceiving and identifying an object in its current location. It can be already argued that the processes of perception and the operation of working memory are less closely linked than has been widely assumed. Moreover, the ability to detect the location of objects and orientate attention towards them appears to be a fundamental, built-in-property of the perception and attention systems. It can be performed by infants who have very limited knowledge and experience of objects. In contrast, object identification requires prior experience with objects, their associated labels, uses and properties. However, the information held in working memory incorporates these associated properties along with information about location, again arguing that a separation between “what” and “where” might be relevant for perception but not for visuospatial working memory. The concept of the so-called “what” and “where” pathways, is overly simplistic at a neuroanatomical level. There are multiple connections and pathways involved following initial processing of sensory input within the primary visual cortex. Different studies showed that the same prefrontal areas in both hemispheres were associated with visual and location tasks when the overall task demands were equated, i.e. the neuroanatomical segregation appears to be associated with task demand, and not with a contrast between object identity and object location (Baddeley et al., 2002). Moreover, the representations that we hold in working memory incorporate information from several sensory modalities (auditory, haptic, kineasthetic, and possibly even olfactory and gustatory) in addition to elements of prior knowledge not immediately available from the perceived scene.

The dissociation between visual and spatial working memory has been reported also in studies of nonhuman primates, electrophysiological studies in healthy adults and neuropsychological studies of brain-damaged patients (Baddeley et al., 2002). The experimental dissociations found in healthy volunteers mirror different patterns of impairment and sparing of visual and spatial working memory function found in neuropsychological patients. The dissociations have been shown in contrasts between single cases as well as between groups of patients.

Research on the visuo-spatial sketch pad has traditionally lagged behind that on the phonological loop. One reason as to why research on the visuo-spatial sketch pad has been rather slower to get off the ground has been the traditional hesitancy psychologists have had in accepting imagery as a valid phenomenon.

It was shown that people can accurately manipulate images of complex shapes. It was reported that the amount of rotation, or angular disparity of line-drawn pictures of three-dimensional complex shapes, dramatically influenced the time subjects took to make the correct decision, with

one increasing linearly as a function of the other. With each additional 60 degree difference in orientation, response time increased by one second. These results were interpreted as an indication that subjects rotate a visual representation of the target shape continuously until it lines up with the new shape; the more rotation required, the more time it takes to do so. In one experiment subjects were asked to imagine pairs of objects in different settings. The rationale for doing so was that in some cases the same object would be imagined as larger than in others and that in such cases, subjects should be able to make judgments about that object faster. This was found to be the case. It was shown that subjects who are congenitally blind perform visual imagery tasks in much the same way as sighted subjects. Thus, when they manipulated an imagined shape, decision time is once again a linear function of the reorientation required, and verification time decreases with the imagined size of the object they are making decision about (Groeger, 1997). For most of us both visual and spatial codes are available, although most of the time they are combined in allowing us to perform various tasks. As a result, it has been rather difficult to separate them empirically.

The memory performance with visuo-spatial information depends on both a passive store which holds visuo-spatial information, and a visuo-spatial control process which can (a) rehearse the contents of the passive store, thus preventing decay; and (b) take in written material and convert it into a visuo-spatial code (i.e. represents it as an image), thus registering it in the passive visuo-spatial store. Justification for these points was for a large part, by analogy rather than through direct empirical observations which was the case with the phonological loop. This was partly because of the lack of a concurrent task, which could be as robust as articulatory suppression was in the case of the phonological loop (Groeger, 1997).

It was shown that development of the visuo-spatial working memory is depended on several factors such as phonological recording, knowledge increase and refinement of long term memory, attentional capacity, information processing speed and strategies (Pickering, 2001).

It was reported a series of studies, which involve an unattended pictures effect, which is analogous to the unattended speech effect described above. Subjects learned lists of auditorially presented concrete words using an imagery strategy or by rote, with irrelevant speech or irrelevant line drawings being presented at the same time. Logie found that irrelevant speech had no effect on retrieval when words were learned using the imagery strategy, but irrelevant pictures reduced the number of concrete words very substantially. In contrast, irrelevant speech and irrelevant pictures had very similar effects when the words were learned using the rote rehearsal strategy. Since the words to be learned were heard rather than seen on presentation, irrelevant speech would not have been expected to impair performance. Similar effects emerged from studies in which color patches,

rather than line drawings, were used, and from studies using continuously changing dot patterns as the irrelevant stimuli (Groeger, 1997).

It was investigated whether the time taken to move between targets in an array is related to “spatial rehearsal”, thus attempting to examine whether *movement-time effect* might provide a visuo-spatial counterpart to the word-length effect (Baddeley, 1997). This provided an attempt to link the visuo-spatial sketch pad more directly with the control of human movement.

Thus, although less well developed than research on the phonological loop and given the intrinsically different properties of the visual and auditory systems, research on the visuo-spatial sketch pad has provided evidence for the involvement both of a passive visuo-spatial store, and an active, imagery-based rehearsal process.

1.3. Central executive

The difficulties in researching the slave systems are increased still further when attempting to study the final component of the system, the central executive (Baddeley, 1996). This has led Baddeley (1986) to admit that it is the least well-documented aspect of the system. Nevertheless, a body of evidence suggests that the central executive is involved in combining information from the slave systems and scheduling their operating; extracting information from longer term memories; selection and implementation of strategies; focusing, switching and maintaining attention; planning; decision making; and even consciousness. Because of this variety of roles played by the central executive, most of the demonstrations of its operations relate to rather complex, often non-laboratory-based tasks.

It was carried out a study of drivers’ decisions to accept, and ability to drive through, various gaps presented to them. They showed that while performing Baddeley’s verbal reasoning task (i.e. two letters presented, BA, and subjects have to decide whether the sentence “A is not preceded by B” is correct), subjects were well able to drive through gaps before them, but the concurrent reasoning task did affect their judgments of which gaps were too narrow to drive through. Occupying the central executive with a reasoning task does not necessarily affect each aspect of a very well practiced routine behaviour. It is often in relation to the timing and initiation of activity that its effects are most frequently observed. Duncan and colleagues again studying the actual driving behaviour of subjects, showed that even with this highly practiced activity, interference from a secondary task (i.e. *random generation* – having to generate, at for example the rate of one per second, sequences of letters or digits which have no linking pattern) was restricted to decision-

making components (for example, gap accepted when overtaking) but did not influence more routine elements (for example, time taken to change gear) (Groeger, 1997).

A number of studies, carried out under laboratory conditions, have shown that memory loads alone (e.g. having to remember increasing numbers of digits) do not influence central executive performance (e.g. performing a verbal reasoning task). This shows that memory capacity and reasoning ability are relatively independent. As has been shown in a number of different domains (for example, chess and bridge), expert players can recall much more from brief glimpses of card or board positions than non-experts. This difference reduces markedly if the cards or positions are random or otherwise not legitimate (Groeger, 1997).

The role of the central executive comes from patients, particularly those who have sustained damage to their frontal lobes. Shallice argued that frontal lobes are involved in retrieving and combining action plans, as well as in organizing and controlling action. Patients of this type experience difficulties associated with a breakdown in what Shallice and Norman had earlier described as the SAS. The SAS is in turn often equated with the central executive. The frontal patients have difficulty in switching from one rule to another (thus exhibiting extensive *perseveration*), and also with tasks requiring *fluency* (e.g. name as many football teams as quickly as possible without repeating any). When errors are not made, frontal patients, albeit correctly, are typically painfully slow at performing the task. Parkin reports a patient (C.B.) with what has become known as *Dysexecutive Syndrome*, who not only experiences considerable difficulty in recall tasks, but also recognition tasks in which more strategic (in this case context-based) rather than familiarity-based retrieval is required (Groeger, 1997).

The term executive function implies a multidimensional construct referring to a variety of loosely related higher-order cognitive processes including initiation, planning, hypothesis generation, cognitive flexibility, decision making, regulation, judgment, feedback utilization, and self-perception that are necessary for effective and contextually appropriate behavior. It comprises numerous subordinate component cognitive operations, with working memory perhaps the most important of these (Miyake et al., 2000). It is important to note that it is quite possible to find impairment of executive functions such as planning, flexibility of thought, and judgment without major change in general intellectual status. Further, while executive disturbances often arise following damage to prefrontal regions, they may also occur in the context of dysfunction to other brain regions. Cognitive flexibility refers to the ability to look at objects/events from many vantage points, particularly when dealing with a novel context. It can be divided into reactive and spontaneous components. Spontaneous flexibility, or fluency, requires the intrinsic generation of

responses or alternatives, typically within a set of constraints, and can be assessed by measures of verbal and nonverbal fluency (Groeger, 1997).

Executive functioning also involves the ability to make judgments in dealing with unfamiliar situations, the ability to make reasonable estimates, to monitor and to self-correct. The goal-directed behavior implies ability to organize information, maintain a record and monitor responses. Executive abilities such as organizing and planning behavior over longer time periods or setting priorities in the face of two or more competing tasks are a large component of everyday activities which needs (Groeger, 1997).

The Dysexecutive Syndrome closely resembles what was once called the “frontal lobe syndrome”, a term that “is used to refer to an amorphous, varied group of deficits resulting from diverse aetiologies, different locations, and variable extents of abnormalities”. Baddeley argue that specification of a syndrome in terms of localization is unfortunate and potentially misleading. We do not classify memory, language, reading or perceptual deficits in this way as it would be inadequate and limit our understanding of the observed cognitive phenomena. Similarly, a functional definition seems more appropriate to the deficits arising from frontal lobe damage. Although there is great variability in the extent and degree of impairment in patients with frontal lobe damage, certain features are highly characteristic. Patients with the Dysexecutive Syndrome are likely to be impulsive, distractible, have problems utilizing feedback and behave inappropriately in social situations. They are not always the easiest of patients to assess because the individual component skills of executive functioning i.e. the building blocks may be intact. What is impaired is the “ability to initiate their use, monitor their performance and use this information to adjust their behavior” (Groeger, 1997).

Characterization and measurement of executive function deficits remains a major challenge in neuropsychology. Although numerous clinical and experimental techniques have been developed, it is important to mention that very few have been shown to have a high degree of sensitivity and specificity with regard to characterizing executive function defects and, relatedly, frontal lobe dysfunction (Groeger, 1997).

One of the promising methods for studying central executive disturbance in patients from different neurological disease populations and particularly dementia patients is dual-task methodology. This is thus the focus of the present study.

1.3.1. Dual-task methodology

The working memory model has depended greatly on the use of the secondary or *dual-task methodology*. This methodology involves the subject carrying out two tasks at once (Bherer et al., 2005; Holtzer et al., 2005; Kemper et al., 2003; Hazeltine et al., 2006). The logic is that if two tasks are similar to each other, needing access to the same information, processes or stores, then performance on one or other task, or both tasks, will suffer. Without a performance decrement, the two tasks or activities are assumed to be independent of one another. This methodology has proved invaluable in exploring a structure, which is hypothetically composed of systems which may interact, or which may be separate.

In Baddeley (1986) studies, two tasks, which should interfere with each other because they both hypothetically depend on the short-term store, were combined with minimal cost, which was difficult to incorporate within a unitary conception of the short-term store. Dual-task methodology contributed significantly in development of the present working memory model.

1.4. Neuroanatomical basis of working memory

As the working memory model was developed in part on detailed studies of brain-damaged patients it can provide significant insight into the possible aspects of brain organization that might be linked to the operation of the various components of working memory. This information is added by the results of the studies that were use neuroimaging techniques in normal subjects as they undertake working memory tasks.

a) Phonological Loop. In the case of the phonological loop, Della Sala and Logie summarize the lesion site for a number of patients with verbal short-term memory deficits who have been described by various researchers in the published literature. For those patients, the lesions were primarily in the lower part of the parietal lobe close to the junction with the upper part of the posterior temporal lobe. This same general area has been confirmed as the common locus of the lesion in group studies of patients with poor digit span. More sophisticated localization techniques have identified the supra-marginal gyrus as the area most commonly damaged in case of verbal short-term memory impairment (Logie et al., 2003). It was suggested that phonological storage can be a function of a complex prefronto-parietal network (Gruber, 2001). A number of studies have used positron emission tomography (PET) during the performance of various working memory tasks (Groeger, 1997). The data are broadly consistent in showing activity in the lower left supra-marginal gyrus during short-term verbal memory tasks, providing evidence that converges with the findings from brain-damaged patients (Miyake & Shah, 1999).

b) The visuospatial Sketchpad. The neuropsychological data about visuospatial sketchpad is not as well endowed as that for the phonological loop. It appears that right hemisphere lesions are more commonly associated with visuospatial memory deficits. There is no clear consensus about more specific anatomical localizations for visuospatial sketchpad. PET studies of the normal brain have implicated activity in the right hemisphere with visuospatial working memory tasks, although which areas are active within hemisphere seems to depend on the nature of the task. It was reported activity in the occipital and parietal areas along with some activity in the prefrontal cortex and premotor areas during visuospatial imagery tasks. In other study additional activity was found in the primary visual areas of the occipital lobe. However, it was noted that the primary visual areas were involved only when their imagery task also involved some visual perceptual input. It was found that tasks involving visual working memory appear to generate activity in a range of areas excluding the right parietal lobe, whereas a spatial working memory task was associated with activity in the superior and inferior parietal cortex (Groeger, 1997). Owen et al. (1999) suggested that the mid-dorsolateral and mid-ventrolateral frontal cortical areas make functional contributions to spatial working memory. It was concluded that visual and spatial working memory are handled by different areas of the cortex, a finding consistent with the suggestion that these two functions of working memory are relatively independent (Miyake & Shah, 1999).

c) The Central Executive. Baddeley (1986) argued that executive or supervisory processes associated with the central executive seem to be closely linked to the prefrontal cortex, although it may not be the only brain area that supports the executive control of behaviour. One finding on the role of the prefrontal cortex in executive function is that performing a language task (for example, semantic judgment) and a visuospatial task (for example, mental rotation) simultaneously may require the contribution of the additional area of the brain – the prefrontal cortex – that is not necessarily implicated in the performance of individual component tasks. The study has also shown that this finding is not merely a simple artefact of task difficulty or effort. It was shown the frontal lobe damage contribution to the central executive functioning, particularly to dual-task performance (Allain et al., 2001; Owen et al., 1998; Andres & Van der Linden, 2002; Szameitat et al., 2002). The biological correlates of the various subcomponents in working memory remain to be fully explored.

2. Vascular Dementia

2.1. The concept of Vascular Dementia.

Dementia can be defined as a global impairment of higher cortical functions, including memory, the capacity to solve the problems of everyday living, the performance of learned

perceptual motor skills and correct use of social skills and control of emotional reactions, in the absence of gross clouding of consciousness. The condition is irreversible and progressive (Baddeley et al., 1986).

Vascular diseases of the brain are widely distributed disease in the population of the world. It causes more deaths and deficits than any other disease. The incidence of vascular disease of the brain and its cognitive causes are perhaps preventable and appears to be declining as a result of identification and treatment of many of the major risk factors. Thus early detection and accurate diagnosis of vascular cognitive impairment and vascular dementia (VaD) is a challenge (Bowler & Hachinski, 1995).

The origins of the concept of VaD can be traced to Binswanger, who proposed the condition ‘encephalitis subchronicalis chronica progressiva’ (Lezak, 1995) considered to arise from pathology in deep perforating cerebral vessels that resulted in the formation of lacunae of infarction and demyelination of deep white matter with the preservation of cortical grey matter. It emerged that Binswanger’s disease was a rare cause of VaD and it was then subsumed under the rubric of arteriosclerotic dementia (arteriosclerotic psychosis). Arteriosclerotic dementia was postulated to arise from ischaemic cerebral injury due to arteriosclerotic narrowing of the cerebral vasculature. Tomlinson distinguished Alzheimer’s disease (AD) from VaD, and demonstrated the importance of cerebral infarction for VaD (Looi, 1999). The concept of VaD was broadened to include cognitive impairment caused by cerebrovascular disease in its various forms. It was recognized that brain impairment could be caused by non-infarcting vascular lesions, which could vary in their distribution, pathology and aetiology.

Until the 1960s, many viewed dementia as a result of chronic diminished cerebral blood flow secondary to atherosclerotic narrowing of cerebral vessels leading to neuronal degeneration and death, that is, “hardening of the arteries” or “atherosclerotic dementia”. In 1968-1970 Tomlinson et al. clarified that senile plaques and neurofibrillary tangles were major findings in AD and set the stage for the modern understanding of dementing disorders. They also described a relationship between the volume of infarcted tissue and dementia, further supporting the concept that cerebrovascular dementia was due to areas of the brain being destroyed and not due to subtle pathological alterations or a gradual degeneration of neurons. In 1974, following the observation that large vessel pathology contributed to the majority of VaD cases, Hachinski et al. coined the term *multi-infarct dementia* (MID) (Adams et al., 1997) to clarify that cerebrovascular disease was responsible for dementia by producing multiple cerebral infarcts of varying size. For nearly two decades, MID became synonymous with VaD. In the 1970s, the emphasis in studies of dementia shifted from vascular to primary degenerative disorders and AD gained prominence as the most

common cause of dementia in the elderly. It has become clear that a broad spectrum of vascular lesions of heterogeneous pathophysiology can lead to a decline in cognitive function and the term multi-infarct dementia has been replaced by *vascular dementia*. Although progress has been made in understanding VaD, many questions remain unanswered. This is especially true in regard to what pathological lesion produces dementia and by what mechanism. There is a great need to improve diagnostic criteria and recognition of VaD because it is one of the major dementing disorders that is currently preventable and treatable.

In the broadest sense, VaD refers to impaired cognitive function that has been caused by cerebral injury secondary to different forms of vascular disease. VaD is a controversial entity viewed differently by clinicians, neuroradiologists and neuropathologists. There are many concepts and opinions about VaD, and reviews, position papers and conceptual publications about the topic abound. Many neuropathologists suggest that it is a rare disorder, whereas others report that it is the second most common cause of dementia. There are widely different estimates on the incidence and prevalence of VaD and major geographic differences. The clinical diagnosis of VaD is often uncertain, and white matter changes observed by magnetic resonance imaging (MRI) and computed tomography (CT) are found commonly in demented individuals with AD and VaD and in normal elderly, and have further clouded the issue of the clinical diagnosis of VaD (Markesbery, 1998). VaD is recognized as the second most common type of dementia in Western countries and, overall, may be the most common type of dementia in the world (Meyer et al., 2001). The concept of VaD has been re-evaluated, with new diagnostic criteria having been proposed (World Health Organization, 1992; American Psychiatric Association, 1994) but without any consensus.

VaD can be classified in terms of the distribution of the infarcts and the size of the blood vessels involved. Occlusion of the small arteries leads to the development of two conditions, namely *lacunar dementia* and *Binswanger's disease*. These two conditions are similar in many ways and often present together. Lacunes are small deep ischaemic infarcts located principally in deep gray nuclei of the basal ganglia, thalamus, internal capsule or pons, with a few appearing in cortical gray matter or in the major cerebral white matter pathways (Markesbery, 1998). When ten or more are present the term lacunar state is applied. In many hypertensive patients deep lacunar lesions are accompanied by superficial cortical infarction (Varma et al., 2002). Lacunar infarcts may also be present in patients with Binswanger's disease, but the most prominent feature of this condition is the presence of multiple infarcts in the white matter of the cerebral hemispheres. The posterior, temporal and occipital white matter is most vulnerable, but in some cases all white matter is affected. The nosological status of Binswanger's disease is controversial. Some researchers suggested that it was a demyelinating condition rather than a vascular disorder; others has argued

that Binswanger's disease and lacunar dementia are one and the same condition; or that the term Binswanger's disease should be abandoned in favor of the more general term leuko-araiosis which they introduced to describe all conditions resulting in a diminution of the density of representation of white matter on CT scan and MRI (Hart & Semple, 1990).

The term VaD has been adopted by major research groups and diagnostic systems. VaD, as currently defined, may develop as a result of multiple infarcts, non-infarct vascular disease, single strategic infarcts, lacunar infarcts, haemorrhage. etc., and the clinical profiles of these "subtypes" can vary considerably. Thus it is difficult to have a single construct of VaD. It has been suggested that the term VaD may have lost its usefulness and should be abandoned (Hachinski, 1994), perhaps to be replaced with the term *Vascular Cognitive Impairment* (VCI) (Looi et al., 2000; Bowler, 2002). "Vascular" refers to all causes of ischemic cerebrovascular disease except stroke, and "cognitive impairment" encompasses all levels of cognitive decline that may fall well short of dementia. Although diagnostic criteria for VCI have not been presented, it serves to take the focus away from dementia and bring it back on the processes that determine cognitive impairment secondary to vascular pathology. This concept leaves a number of issues unresolved. First, when do cognitive deficits constitute "impairment"? Should this be a statistical concept based on normative data, or a demonstration of decline from an established or putative premorbid level in an individual, or indeed a demonstration of functional disability? Vascular cognitive impairment (VCI) was proposed as an umbrella term to include subjects affected with any degree of cognitive impairment resulting from cerebrovascular disease, ranging from mild cognitive impairment (MCI) to vascular dementia. The definition of dementia in VaD is based on presence of abnormal executive control function, severe enough to interfere with social or occupational functioning (Roman et al., 2004). The distinction between deficits, impairment, and disability is more than a semantic exercise as the implications for the patient and the clinician are different for each. Second, the emphasis on early or minimal dysfunction is laudable but the difficulties in establishing subtle deficits in these patients who often have comorbid depression, anxiety, and other emotional disturbance, should not be underemphasized. The difficulties in diagnosing early cerebrovascular disease are also substantial, with the ubiquitous presence of hyperintense signals on T2-weighted MRI in the elderly making their unequivocal interpretation difficult. Third, the decision to exclude "major stroke", as is being suggested, is arbitrary as it excludes some but not all cases of cerebral infarction, and disregards the fact that stroke patients often have cerebrovascular disease beyond what the apoplectic event implies. Fourth, the alternative of VCI does not acknowledge the difficulties dimensional constructs impose on clinical practice. Clinicians prefer to deal with categorical disorders that enable a clearer delineation of diagnostic and treatment issues and prognosis. Sachdev & Broadaty (1999) proposed

that if abandoning the term “dementia,” categorical entity “disorder” should not be disregarded, for which operational criteria need to be developed. They suggest an alternative term *vascular cognitive disorder* (VCD), which is diagnosed in those individuals who have VCI to a degree that leads to disability or restriction in function. VCD could include many syndromes and even diseases within its fold, better delineation of which in due course will lead to a more rational classification. VCD goes a step further than VCI in advocating the need for a categorical diagnosis but without the limitations that dementia imposes. Implicit in it is the fact that cerebrovascular disease may also result in noncognitive psychiatric disorders such as depression (Sachdev & Broadaty, 1999).

The terms “vascular dementia” and “poststroke dementia” (PSD) are respectively used for two different clinical situations. The term PSD includes any type of dementia occurring after stroke, irrespective of its presumed cause. VaD accounts only for part of PSD and may occur without any obvious clinical history of stroke. Strokes lead to a high risk of cognitive impairment and dementia (Pasquier et al., 2000). It should be noted that in a sizeable proportion of individuals multiple infarcts coexist with the presence of Alzheimer-type pathological change. This condition is termed *mixed dementia* (MD). Although AD can be diagnosed with a considerable degree of accuracy, the distinction between isolated AD, VaD, and MD, remains a controversial issue and one of the most difficult diagnostic challenges. Although MD represents a very frequent pathology, especially in older people, as reported in neuropathological studies, the respective importance of degenerative and vascular lesions, their interaction in the genesis of dementia, and the mere existence of MD are still debated. Mixed AD and VaD is characterized by the clinical and pathological alterations of both AD and stroke (Fillit & Hill, 2002; Rockwood et al., 2000; Riekse et al., 2004; Urakami, 2004). Accurate diagnosis of MD is of crucial significance for epidemiological purposes and for preventive and therapeutic strategies (Zekry et al., 2002).

2.2. Epidemiology

2.2.1. Prevalence

There is considerable lack of agreement about the prevalence of VaD (Yamada et al., 2002). A review of clinical studies showed that the frequency of VaD ranged from 4.5% to 39%, although it was suggested that 10% or less represented a more accurate estimate of the contribution of cerebral vascular disease to the incidence of dementia. Much of the disagreement about the prevalence of VaD can be explained by differences in the definition of VaD, dissimilarities in the types and ages of populations studied, in geographic regions, and whether mixed VaD and AD subjects are included (Markesbery, 1998). Although epidemiological studies are limited by diagnostic

uncertainties, they suggest that stroke increases the risk of dementia. The mortality rate is higher in VaD than in AD. Community-based studies have provided several consistent findings: (i) age dependence with prevalence rates doubling every 5 years, (ii) a higher frequency in men, but according to some studies both sexes are equally affected and (iii) nation-to-nation differences. The prevalence of VaD ranges from 2.2% in 70- to 79-year-old women, to 16.3% in men >80 years. One sixth of acute stroke patients have pre-existing dementia (Leys et al, 1998).

Epidemiologic studies around the world suggest that severe dementia occurs in about 5% of people 65 years of age or older, and that mild to moderate dementia occurs in another 10% (Brust, 1983). In clinical studies reported from Japan, the prevalence of VaD is more than double that of AD, reaching approximately 56% of subjects with dementia. In a prospective cohort study of elderly Japanese subjects, using either autopsy or CT scans for morphological examination of the brain, was found 48.5% had VaD and 40.8% had AD. The higher prevalence rate of dementia in Japanese-Brazilians compared with several studies in Japan may indicate the importance of dietary factors rather than genetic factors (Yamada et al., 2002). It was shown that Japanese men living in Hawaii had high rates of VaD and that the rates were similar to those reported in Japan. In Japanese 1999 study among the 58 cases of dementia, the frequency of VaD was 43%: the rate was 2 times higher than that for AD (Kiyohara, 1999). The incidence of VaD in Beijing, China is reported to be 1.5 times that of AD. In addition, there is evidence of an increase in VaD in Russia. A review of the prevalence of VaD in Europe showed that AD was more common than VaD but the prevalence of VaD increased steeply with age and was generally higher in men. A population-based study of 474 demented subjects in Rotterdam revealed that 16% had VaD. In a Swedish study of demented patients over the age of 85 years, 47% had VaD and the overall prevalence of VaD was 14% for that age group (Markesbery, 1998).

It was found that the prevalence rate of vascular dementia is 1.5% in Western countries and approximately 2.2% in Japan. In Japan, it accounts for 50% of all dementias that occur in individuals older than 65 years. In Europe, vascular dementia and mixed dementia account for approximately 20% and 40% of cases, respectively. In Latin America, 15% of all dementias are vascular. In community-based studies in Australia, the prevalence rate for vascular and mixed dementia is 13% and 28%, respectively. The prevalence rate of dementia is 9 times higher in patients who have had a stroke than in controls. One year after a stroke, 25% of patients develop new-onset dementia. Within 4 years following a stroke, the relative risk of incident dementia is 5.5. In technologically developed countries population is aging rapidly. This demographic change in the population has brought dementia and cerebrovascular disease into focus. In a community-based study of Sydney elderly (75 years and older) was found that of the 92 people diagnosed with

“probable” dementia, 13% had VaD alone, and another 11% had a mixed vascular and “other” dementia. VaD is, therefore, the second most frequent cause of dementia in Australia (Sachdev & Brodaty, 1999). Most of the studies that report low prevalence rate for VaD tend to exclude cases with vascular pathology (Zekry et al., 2002).

2.2.2. Incidence

Very few population-based studies have systematically examined incidence of VaD (Fitzpatrick et al., 2004; Suh & Shah, 2001). The incidence of VaD has been studied much less extensively than that of AD, and substantial variations in the incidence rates have been observed: annual incidence rates (per 100,000) range from 20 to 40 between 60 and 69 years of age and from 200 to 700 over 80. The incidence rate of VaD declined over the last 2 decades, probably as a consequence of effective stroke prevention (Leys et al., 1998). In community-based studies, the incidence of VaD has ranged from 0.17 to 0.71 per 100 person-years. In a sample of hospitalised ischaemic stroke patients, the incidence of VaD was estimated to be 8.4 per 100 person-years. Dementia was diagnosed in 26.3% and 31.8% of patients, respectively, in two studies at three months after an acute stroke. In Italian study (Di Carlo et al., 2002) average incidence rates per 1000 person-years were 12.47 for dementia, 6.55 for AD and 3.30 for VaD.

In the US the incidence of dementia associated with stroke may be high, with 10-35% of patients developing dementia within 5 years following a hemispheric stroke. One-fourth of stroke patients develop new-onset dementia 1 year after stroke. In the Kokmen et al. (1996) population-based study on the incidence of dementia in patients with stroke was conducted over an observational period of 25 years. The cumulative incidence of PSD increased from 7% at year 1 to 48% at year 25; using a standardized mortality ratio, the relative risk of dementia was 8.8 one year after stroke and decreased to 2.0 at the end of follow-up, the incidence of AD being doubled in stroke patients. One-third of patients developing PSD already had some degree of pre-existing cognitive decline (Pasquier et al., 2000). Patients with symptomatic hemispheric strokes have a 4-fold increase in the risk of dementia compared to age-matched controls. Patients with clinically silent strokes have a 2-fold increase in the risk of dementia compared to age-matched controls.

Internationally incidence of VaD in Southeast Asia may be greater than in Western countries because of a higher incidence of cerebrovascular disease in that part of the world. However, geographic differences may reflect diagnostic biases rather than true epidemiologic differences. In Rochester, 1985-1989 482 incident cases of dementia were found. Overall, 10% of patients had onset or worsening of their dementia within 3 months of a stroke (Knopman et al., 2002). In Spain incidence rate per 1,000 person was 9.5 (95% CI = 6.7-12.1) for VaD (Fitzpatrick et al., 2004;

Lopez-Pousa et al., 2004). From the Canadian Study of Health and Aging cohort, incidence rates of VaD were determined. On the basis of 38 476 person-years at risk, the annual incidence rate was estimated to be 2.52 per thousand undemented Canadians (95% CI 2.02 to 3.02). Including an estimation of the probability of VaD among the decedents, this figure rose to 3.79 (Lindsay et al., 2002). Netherlands's large population-based study reveals that overall incidence of vascular dementia was lower in women than in men (rate ratio 0.57, 95% CI: 0.34-0.97) (Ruitenberg et al., 2001). In Japanese 1999 study the age-adjusted total incidence (per 1,000 person-years) of VaD were 12.2 for men and 9.0 for women, and for AD 5.1 for men and 10.9 for women (Kiyohara, 1999). Very few studies have evaluated the incidence of specific types of dementia, and particularly incidence data for MD (Zekry et al., 2002).

2.3. Risk factors

Etiology of VaD is presently considered as multidimensional, involving genetic, biological and psychological factors (Ikeda, 2003; Suh et al., 2003).

Strokes are common in the elderly but the factors that determine which stroke victims develop dementia are not understood adequately (Madureira et al., 2001). It is generally assumed that the risk factors for VaD are similar to those for stroke (Yamada et al., 2003). A few studies have attempted to separate the risk factors for VaD from those for stroke. Age, lower education attainment, myocardial infarction and recent cigarette smoking were independent predictors of dementia associated with strokes. A prospective cohort study of elderly Japanese subjects suggested that advanced age, prior stroke, elevated systolic blood pressure and alcohol consumption were significant independent risk factors for VaD. It is suggested that brain reserve (larger brains, more functionally intact neurons or synapses and higher intelligence) may be an important factor in cognitive reserve (Markesbery, 1998).

The subject of elevated blood pressure and cognitive function is complicated. Some population-based studies found no relationship between high blood pressure and cognitive function but some others found significance relationship between them. Age, male gender and second strokes were found to be significant independent predictors of dementia.

Numerous studies have shown that type 4 allele of apolipoprotein-E (APOE) is one of a major risk factor for VaD (Markesbery, 1998).

Although further studies are needed, overall, it appears that age, systolic and/or diastolic hypertension, diabetes melitus, prior stroke, lower educational attainment, cigarette smoking, myocardial infarction, excessive alcohol consumption and the presence of the APOE- ϵ 4 allele may be significant risk factors for VaD. A small number of VaD cases are transmitted as autosomal

dominant traits - a hereditary form of VaD, cerebral autosomal dominant arteriopathy with subcortical infarcts and leukoencephalopathy (CADASIL), was described (Markesbery, 1998).

2.4 Diagnostic criteria

The earliest clinical diagnostic criteria for VaD, the Hachinski Ischemic Scale (1975) used the following clinical findings: abrupt onset, stepwise deterioration, fluctuating course, nocturnal confusion, hypertension and a history of neurological symptoms. However, the ischemic score was unable to differentiate the AD from VaD (Pasquier et al., 2000). This approach has been validated in its ability to distinguish a relatively pure MID from AD or MD, but it has limitations in that it focuses on MID to the exclusion of other subtypes of VaD and uses only some of the relevant clinical information, disregarding neuroimaging and other laboratory data.

The two key elements implemented in the clinical criteria for VaD are (i) the definition of the dementia and (ii) the definition of the vascular disorder. All the clinical criteria used are consensus criteria, which are neither derived from prospective community-based studies on vascular factors affecting the cognition, nor based on detailed natural histories. All the existed criteria are based on the ischemic infarct concept and designed to have high specificity, although they have been poorly implemented and validated (Pasquier et al., 2000).

The criteria suggested by the Diagnostic and Statistical Manual of Mental Disorders (American Psychiatric Association, 1994, DSM-IV) include:

- development of multiple cognitive deficits manifested by impairment of one or more of the following: memory decline, aphasia, apraxia, agnosia or disturbance in executive function;
- an impairment of social or occupational function that represents a significant decline from a previous level of functioning;
- focal neurological signs and symptoms including exaggerated deep tendon reflexes, extensor planter responses, pseudobulbar palsy, gait abnormalities, weakness of an extremity, or laboratory evidence of cerebrovascular disease (multiple infarctions involving cortex and underlying white matter) etiologically related to the clinical picture;
- lack of delirium.

The course is specified by sudden cognitive and functional losses. Brain imaging requirements are not detailed. The DSM-IV definition for VaD is reasonably broad and lack detailed clinical and radiological guidelines (Pasquier et al., 2000).

The international Classification of Disease (ICD-10) criteria of VaD (World Health Organization, 1992) cite evidence of dementia, unequal deficits in higher cognitive functions, focal neurological signs (unilateral spastic weakness of the limb, increased deep tendon reflexes, extensor plantar response, pseudobulbar palsy), and evidence from the history, examination or laboratory studies of cerebrovascular disease etiologically related to the dementia. Both the DSM-IV and the ICD-10 criteria are quite subjective. The criteria do not detail brain imaging requirements. The ICD-10 criteria specify altogether six subtypes of VaD. The ICD-10 criteria for VaD have been shown to be highly selective and only a subset of those fulfilling the general criteria for ICD-10 VaD can be classified into defined subtypes. The shortcoming of these criteria include lack of detailed guidelines, e.g. unequal cognitive deficits and neuroimaging, lack of etiological cues, and heterogeneity (Pasquier et al., 2000).

Two sets of criteria were proposed for the clinical diagnosis of VaD. The criteria of the National Institute of Neurological Disorders and Stroke-Association Internationale pour la Recherche et l'Enseignement en Neurosciences (NINDS-AIREN) (Roman et al., 1993) for probable VaD are:

- the presence of dementia (cognitive decline manifested by impairment in memory, and two or more cognitive functions established by clinical examination and documented by neuropsychological testing);
- presence of cerebrovascular disease (defined by the presence of focal neurological signs, such as hemiparesis, lower facial weakness, Babinski sign, sensory deficit, hemianopsia and dysarthria, consistent with stroke and verifies by brain imaging);
- causal relationship between the two criteria above.

The criteria for definite VaD are:

- clinical criteria for probable VaD;
- histopathological evidence of cerebrovascular disease on biopsy or autopsy;
- absence of neurofibrillary tangles and neuritic plaques exceeding those expected for age;
- absence of other clinical or pathological disorders capable of producing dementia.

Criticisms of these criteria are that the definition of dementia is too strict, there is a lack of crisp imaging findings, and all patients with stroke who have lost intellectual ability are included. The NINDS-AIREN criteria recognizes heterogeneity of the syndrome and variability of the clinical course in VaD, highlights detection of ischemic lesions and a relationship between lesion and cognition, as well as stroke and dementia onset. The inter-rater reliability of the NINDS-AIREN criteria has been shown to be moderate to substantial.

Another set of criteria for probable ischemic VaD proposed by the State of California Alzheimer's Disease Diagnostic and Treatment Center (ADDTC) (Chui et al., 1992) includes:

- dementia;
- evidence of two or more ischemic strokes by history, neurological signs, or neuroimaging studies, or the occurrence of a single stroke with temporal relationship to the onset of dementia;
- evidence of at least one infarct outside the cerebellum by neuroimaging

Definite ischemic VaD criteria include:

- clinical evidence of dementia;
- pathological confirmation of multiple infarcts, some outside the cerebellum.

In the above criteria, the essential elements for the clinical diagnosis of VaD are the presence of dementia and cerebrovascular disease clinically and by neuroimaging, and a causal link between the two. However, it is not possible to define the presence of pathological manifestations of AD or other dementing disorders from clinical criteria making a definitive diagnosis uncertain. The NINDS-AIREN group rejected the diagnosis of mixed dementia and in its place uses AD with cerebrovascular disease. This leaves the common overlap entity of AD with vascular lesions as a vague concept. The California ADDTC uses a broader interpretation of MD to mean the presence of one or more systemic or brain disorders thought to be causally related to the dementia. The ICD-10 uses the term MD for patients who met criteria for VaD and AD. Alternatively, the ADDTC criteria define MD as a disorder in which there is evidence of ischemic vascular disease with the presence of one or more other systemic or brain disorders that are thought to be causally related to the dementia.

One of the problems in the clinical evaluation of VaD patients is the lack of sound neuropsychological criteria to refinement of which is devoted the presented study.

2.5. Subtypes of VaD

One possible approach to dealing with the clinical and neuropathological heterogeneity of VaD is to subcategorize it into somewhat more distinctive syndromes based on a combination of neuropsychological profiles and structural abnormalities. Classification of VaD may be based on (i) the underlying vascular pathology, (ii) the type of brain lesions, (iii) the location of brain lesions, (iv) the clinical syndrome. The subtypes of VaD included in current classifications are the cortical VaD (or multi-infarct dementia), the subcortical VaD (or the small vessel dementia), and the strategic infarct dementia. Many classifications also include hypoperfusion dementia. Further

classifications include hemorrhagic dementia, hereditary VaD, and combined AD with cerebrovascular disease (Pasquier et al., 2000).

As was indicated above, the current clinical criteria for VaD differ in their classification of VaD into subtypes. None of them include detailed criteria for their subtypes. The DSM-IV (American Psychiatric Association, 1994) does not specify subtypes. The ICD-10 (World Health Organization, 1992) include six subtypes with rather superficial clinical descriptions (acute onset, multi-infarct, subcortical, mixed cortical, mixed cortical and subcortical, other, and unspecified). The criteria are selective as only a subset of those fulfilling the general criteria for ICD-10 VaD can be classified into defined subtypes. The ADDTC criteria do not specify detailed subtypes, but highlight that classification of ischemic VaD for research purpose should specify features of the infarcts that may differentiate of the disorder, such as location (cortical white matter, periventricular, basal ganglia, thalamus), size (volume), distribution (large, small or microvessel), severity (chronic ischemia versus infarction), etiology (embolism, atherosclerosis, arteriosclerosis, cerebral amyloid angiopathy; hypoperfusion). The NINDS-AIREN criteria include without detailed description cortical VaD, subcortical VaD, Binswanger's disease, and thalamic dementia (Pasquier et al., 2000).

The following subtypes of VaD are characterized here in details:

1. **Cortical dementia**, based on multiple infarctions of the cortex. This category would be within the concept of MID. Cortical VaD relates to large-vessel disease, cardiac embolic events and also hypoperfusion. It shows predominantly cortical and cortico-subcortical arterial territorial and distal field (watershed) infarcts. Typical clinical features are lateralized sensorimotor changes and abrupt onset of cognitive impairment and aphasia. In addition, some combination of different cortical neuropsychological syndromes has been suggested to be present in cortical VaD. This group shows heterogeneity in regards to the etiologies, vascular mechanisms, changes in the brain, as well as clinical manifestations.
2. **Cortical-subcortical dementia**, consequent upon multiple cortical infarctions as well as subcortical pathology, in the form of either large or lacunar infarcts in the white matter or deep ganglia or noninfarction ischemia of the white matter. This category is also entailed within MID.
3. **Subcortical dementia**, based on the presence of ischemic pathology in the white matter and/or subcortical nuclei. That subcortical pathology due to vascular factors may lead to a dementia syndrome has been recognized for over a century. Investigations with CT and MRI have demonstrated that white matter pathology is common in the aging brain, and it is associated with cognitive impairment above a certain threshold. While the concept of Binswanger disease

continues to be controversial, partly because Binswanger cases were incompletely characterized, the recognition of a subcortical form of VaD is receiving increased recognition. Dementia due to lacunar infarcts is included in this form of dementia. Subcortical VaD may represent a relatively homogeneous form of VaD, the pathogenesis of which needs to be investigated more thoroughly. It also should be investigated whether subcortical lesions are an essential component of all vascular dementias. It may be appropriate to examine cases of subcortical dementia with either white matter or gray nuclei lesions separately, and those with mixed lesions. The subcortical VaD incorporate small vessel disease as primary vascular etiology, lacunar infarcts and white matter lesions as primary types of brain lesions, and subcortical location as the primary location of lesions. The ischemic lesions in VaD affect especially the prefrontal subcortical circuit including prefrontal cortex, caudate, pallidum, thalamus, and the thalamo-cortical circuit (genu of anterior limb of the internal capsule, anterior centrum semiovale, and anterior corona radiata). Accordingly, the subcortical syndrome is the primary clinical manifestation. Dementia is not always present in patients with a lacunar state. As was mentioned, lacunar infarcts appear as small miliary softenings, mostly located in the putamen, thalamus or pons, or in the deep white matter. They are small (5 to 15 mm) cavitations filled by a fine network of astrocytic processes, macrophages and siderophages, surrounded by fibrillary and protoplasmic astrocytes and sometimes also by hemosiderin pigments. They are the consequence of the occlusion of one single, deep perforating artery. Multiple lacunes, in association with diffuse white matter changes, have been reported as the anatomical substrate of progressive cognitive decline in some patients who were clinically diagnosed as having AD, in the absence of a history of stroke and of a stepwise course of dementia. In demented with similarly progressive decline and absence of clinical strokes, diffuse white-matter changes without lacunes were neuropathologically described. These cases were however clinically diagnosed as VaD. Such arteriopathies are usually due to chronic arterial hypertension. Small-vessel disease is the consequence of the occlusion of one single, deep perforating artery, caused by segmental fibrinoid degeneration with lipohyalinosis. Many perforating branches have multiple stenosis and poststenotic dilatations, suggesting that some hemodynamic events might also play a role, rather than local thrombosis. Stroke patients with lacunes are more likely to have white matter changes and to develop dementia than patients with other stroke subtypes.

4. **Strategic-infarct dementia:** Dementia has been described in association with single infarcts in strategic locations, e.g., inferior capsular genu, angular gyrus, left temporoparietal infarct etc. The status of these dementia syndromes should be clarified further. Focal, often small, ischemic lesions involving specific sites critical for higher cortical functions have been classified

separately. This group shows most heterogeneity. Isolated brain infarcts or hemorrhages may lead to dementia. In such cases, dementia is due to the location of the lesion, rather than the volume of brain loss. Each of the following cortical locations has been associated with neuropsychological impairment leading to dementia: left angular gyrus infarcts; right hemisphere angular gyrus infarcts; inferomesial temporal infarcts; and mesial frontal infarcts. Isolated subcortical vascular lesions consist of lacunar infarcts, deep territorial infarcts and deep hemorrhages, disrupting specific subcortical-cortical functional loops crucial for the maintenance of cognitive status. Dementia has been reported in thalamic (Szirmai et al., 2002), left-sided capsular genu, and caudate nuclei infarcts.

5. **Hypoperfusion dementia:** Global brain ischemia secondary to cardiac arrest or profound hypotension, or restricted hypoperfusion in the watershed territories, may also present a picture of dementia. This syndrome remains to be characterized in detail (Sachdev & Brodaty, 1999).

2.6. Pathological mechanisms

Pathogenesis of dementia is multidimensional, involving genetic, biological and psychological factors. Several pathological factors can substantially contribute to development of VaD:

- Volume of brain destruction
- Location of vascular lesions
- Number of cerebral vascular lesions

2.6.1. Volume of Brain destruction

In 1970 Tomlinson and colleagues suggested that infarct size was important in VaD - patients with infarctions of several hundred milliliters of brain might experience intellectual decline. It was indicated that gross infarct volumes of greater than 100 ml caused dementia, and infarct volumes between 50 and 100 ml produced dementia less consistently. They also observed a few patients with infarcts of lesser volume who were demented. A quantitative MRI study, comparing stroke patients with and without dementia, demonstrated that total cerebral infarcted area and cortical involvement were significantly larger in the demented group. In a study of 28 demented patients with vascular lesions, the volume of infarcted brain was over 2-fold greater in the demented patients than it was in the nondemented subjects - the mean total volume of infarcted tissue was 33.2 parts/1000g, or 39-44g of tissue (Markesbery, 1998). Only three patients had brain lesions larger than 100 g, and 17 patients had smaller volumes within the range of the nondemented subjects. These latter studies suggest that dementia is not directly and consistently related to the volume of infarction.

2.6.2. Location of vascular lesions

The location of the vascular lesion in specific brain regions is probably more important than the volume of tissue destruction. Vascular lesions in the following brain regions can lead to dementia: dominant angular gyrus, anterior cerebral artery (ACA) territory, posterior cerebral artery (PCA) territory with temporal-occipital and thalamic involvement, bilateral medial thalamus lesions, dominant hemisphere caudate nucleus, inferior genu of the internal capsule, hippocampus and/or amygdala, and basal forebrain.

It was described similarities between the clinical findings of vascular lesions in the angular gyrus (posterior middle cerebral artery (MCA) territory) and AD. Patients with the angular gyrus syndrome have fluent aphasia, alexia, acalculia, right-left disorientation, finger agnosia and constructional disturbances. Focal motor or sensory signs may not be present. Word finding difficulties and verbal paraphasias are often prominent. Differentiating dementia in patients with aphasia from dominant hemisphere MCA strokes can be quite difficult. It was demonstrated that intellectual decline occurs most frequently in association with aphasia. Ischemic stroke patients were studied that had cognitive impairment of memory, orientation, language and attention, the cognitive domains most likely to be impaired and that was associated most frequently with infarction in the left ACA and PCA territories. PCA occlusion with temporal-occipital lobe and thalamic infarction can cause deficits in intellectual function. Bilateral PCA occlusion results in severe amnesia, cortical blindness and prosopagnosia and is more likely to result in a more serious intellectual decline (Markesbery, 1998).

Patients with thalamic vascular lesions experience sensory loss, mild motor impairment, oculomotor disorders and, if the dominant hemisphere is involved, language dysfunction; disorders of arousal, ranging from coma to mildly diminished alertness. An impairment of memory after vascular lesions of the thalamus has been reported frequently. Decline in attention, inertia, apathy and slow information processing, but not apraxias, agnosias or specifically defined aphasias are typical of subcortical dementia. Bilateral paramedian thalamic infarction frequently can cause Korsakoff-like amnesic syndrome, anterograde and retrograde deficit with verbal and non-verbal memory impairment, confusion, memory impairment and confabulation. It was described impaired memory, personality change, and diminished visuospatial processing in patients with left thalamic lesions. Two patients with right thalamic lesions showed no memory decline and no language abnormalities. Lesions in branches the PCA usually involve other structures. However, there is considerable inconsistency in the literature about vascular lesions of the thalamus causing dementia (Markesbery, 1998).

Involvement of the basal ganglia, especially the head of the caudate nucleus, by lacunar infarcts has been correlated with dementia and behavioral changes as abulia, depression or memory decline, apathy and disinhibition. On neuropsychological testing, they demonstrated impaired planning and sequencing, short attention spans and a decreased free recall of episodic and semantic items. It was described abulia, agitation, hyperactivity, neglect and memory impairment in patients with unilateral caudate infarctions. These studies suggested that the caudate nucleus is important in mediating prefrontal behavior and the integration of memory. It was described a syndrome of fluctuating alertness, inattention, memory loss, apathy, abulia and psychomotor slowing in unilateral lacunar infarction of the inferior genu of the internal capsule.

Because the hippocampus is important in memory, it is logical that infarcts involving the hippocampus would be associated with dementia. Hippocampal sclerosis, especially bilateral, can be the pathological substrate for dementia and most often related to previous hypoxic-ischemic injury, can be found as isolated pathological lesions and in conjunction with other vascular lesions (Markesbery, 1998).

Several studies have shown that patients with basal forebrain lesions following surgery for anterior communicating artery aneurysms develop persistent memory impairment and personality changes (Markesbery, 1998). These lesions more often involve the medial septal nucleus, nucleus accumbens and the diagonal band of Broca.

Several autopsy studies have emphasized that bilateral cerebral infarcts were associated with VaD. However, brain imaging and clinical studies have suggested left hemisphere lesions predominate in VaD. It is suggested that the left hemisphere is more important in intellectual functioning than the right. A recent correlative positron emission tomography and MRI study revealed that cortical metabolic dysfunction is related to ischemic subcortical lesions in VaD (Markesbery, 1998).

2.6.3. Number of cerebral vascular lesions

One of the concepts embodied in VaD is that multiple small infarcts, irrespective of their volume, can lead to intellectual decline. However, few studies have addressed the important problem of the number of lesions in VaD, and whether several large infarcts are more likely to cause dementia than multiple small infarcts. It was found that the mean number of infarcts in VaD was 5.8 compared with 0.2 in AD and 2.0 in mixed AD and VaD. The differences reached statistical significance in ACA and MCA territory. It should be underscored that many patients have a considerable volume of cerebral infarction and neurological deficits but they do not exhibit

significant cognitive impairment. Although infarct location, size and number are important, other factors, such as age, systemic diseases, other brain lesions and the degree of CNS aging changes, are involved in determining whether an individual will develop intellectual decline (Markesbery, 1998).

2.7. Neuropathology

Frequent clinical neurological findings indicating focal brain lesion early in the course of VaD disease include: mild motor or sensory deficits, decreased coordination, brisk tendon reflexes, Babinski's sign, field cut, bulbar signs including dysarthria and dysphagia, extrapyramidal signs (mainly rigidity and akinesia), gait disorder (hemiplegic, apractic-atactic or small-stepped), unsteadiness and unprovoked falls, as well as urinary frequency and urgency. On the other hand, features that make the diagnosis of VaD uncertain or unlikely include absence of focal neurological signs, other than cognitive disturbance. In cortical VaD typical clinical features are sensorimotor changes and abrupt onset of cognitive impairment and aphasia, and in subcortical VaD disease pure motor hemiparesis, bulbar signs and dysarthria (Pasquier, et al., 2000). The clinical neurological findings especially early in the course of subcortical VaD include episodes of mild upper motor neuron signs (drift, reflex asymmetry, incoordination), gait disorder (apractic-atactic or small-stepped), imbalance and falls, urinary frequency and incontinence, dysarthria, dysphagia, extrapyramidal signs (hypokinesia, rigidity). However, often these focal neurological signs are subtle only (Pasquier, et al., 2000).

2.8. Neuropsychology

The cognitive syndrome of VaD is characterized by (i) memory deficit, (ii) dysexecutive syndrome, (iii) slowed information processing, and (iv) mood and personality changes. These features are especially typical for cases with subcortical lesions. The patients with cortical lesions have in addition often a combination of different cortical neuropsychological syndromes (Pasquier et al., 2000; McPherson & Cummings, 1996).

The memory deficit in VaD is often less severe than in AD, and consists impaired recall, relative intact recognition, less severe forgetting and better benefit from cues. The dysexecutive syndrome in VaD includes impairment in goal formulation, initiation, planning organising, sequencing, executing, set-shifting and set-maintenance, as well as in abstracting. The dysexecutive syndrome in VaD relates to lesions affecting the prefrontal subcortical circuit including prefrontal cortex, caudate, pallidum, thalamus, and the thalamo-cortical circuit (capsular genu, anterior centrum semiovale, and anterior corona radiata). Relatively preserved personality and insight in

mild and moderate cases of VaD is typical. Behavioral changes including depression, personality change, emotional lability and incontinence, as well as inertia, emotional bluntness and psychomotor retardation (Pasquier et al., 2000). VaD patients show impairment of mental speed and stimulus response initiation (Mendez et al., 1997).

An examination of the published literature on the neuropsychological deficits in VaD, particularly in comparison with AD at the same stage of dementia, reveals the VaD subjects to be superior in verbal long-term memory and more impaired in frontal-executive functioning (Sachdev & Brodaty, 1999). VaD patients, furthermore, present with a greater variation in their cognitive profiles reflecting the patchiness of structural and functional loss. The relative excess of deficits in faculties ascribed to prefrontal lobe function in VaD has, however, been pointed out by many investigators. Compared to VaD, patients with AD may exhibit greater deficits in functions (including memory) mediated by posterior cortical structures, such as the temporal and parietal lobes. AD patients exhibit a faster rate of information decay, reduced ability to benefit from cues to facilitate retrieval, and higher frequency of intrusion errors; in addition, certain aspects of language function, such as naming, may exacerbate deficits on verbal memory tasks. AD tends to affect lexicon while VaD tends to affect syntax. Given the findings on the relative preservation of verbal learning and memory in VaD compared with AD, the validity of the primacy of memory impairment in the various criteria of VaD is questionable. The requirement for memory impairment in existing models of VaD may bias the samples of VaD, selecting those that closely resemble AD. This may explain some of the current difficulties in distinguishing between the dementia types on neuropsychological testing.

Despite the inherent heterogeneity in the definition of VaD, the findings of frontal-executive dysfunction and deficits in verbal learning remain robust. This result can be explained by the frequent presence of lesions in structures that comprise the frontal-subcortical circuits. The circuits implicated in VaD include the dorsolateral prefrontal circuit mediating executive function, the orbitomedial circuit mediating emotional lability and the anterior cingulate circuit responsible for motivation and initiation. In the current definitions of VaD, frontal-executive dysfunction is not a necessary criterion for the diagnosis. Because it is a common and important aspect of VaD, distinguishing it from AD, greater importance should be assigned to this feature (Sachdev & Brodaty, 1999).

Bilateral anterior cerebral artery occlusion (e.g., when both vessels arise from a common trunk) can cause behavioral disturbance, ranging from decreased initiative to abulia with severe psychomotor bradykinesia. Similar symptoms have also followed unilateral occlusion, usually of the language-dominant hemisphere. Again, which particular regions are responsible (e.g., the

supplementary motor area or subfrontal limbic structures) is unclear. An acute state of confusion and agitation has followed unilateral cingulate infarction.

Middle cerebral artery occlusion most often causes dementia in association with aphasia, present in 20% of stroke victims. Aphasia and dementia are not, of course, the same thing, and some patients, particularly those, whose aphasic phenomena conform to clinically stereotypic subtypes, may have seemingly well-preserved cognitive function outside the language sphere. However, when aphasia is severe, and especially when it is of a mixed or global type, it hardly ever exists in isolation, for language itself is not a mental activity that can be isolated. Temporal integration underlies other mental capabilities as well, for example, praxis, and when temporal integration is impaired, cognitive skills in addition to language will be affected.

Early in the course of VaD, cognitive deficits are likely to predominate while personality deterioration lags behind, although eventually both aspects of behavior may become profoundly disordered. VaD patients tend to retain awareness of their disabilities (Bathgate et al., 2001). Given this awareness it is not surprising to find as many as 60% of VaD patients displaying depressive symptoms. Threatening delusions, such as being robbed or having an unfaithful spouse, are likely to occur in half of these patients at some time in their course (Lezak, 1995). Depression, anxiety, emotional lability and incontinence, and other psychiatric symptoms are frequent in VaD. Depression, abulia, emotional incontinence and psychomotor retardation are frequent in subcortical VaD (Pasquier et al., 2000). Psychiatric morbidity is a common feature of VaD with a reported excess of behavioral retardation, depression, anxiety, emotionalism, and apathy in these patients.

3. Episodic Memory

3.1. Concept of episodic memory.

The term “episodic memory” refers to individual’s capacity to recollect specific incidents from the past, remembering incidental detail that allows us in a sense to relive the event or, as Tulving phrases it, to “travel back in time” (Baddeley AD et al., 2002). Tulving proposed to distinguish between two declarative (explicit) long-term memory systems what he termed “semantic memory” and “episodic memory”. Semantic memory was assumed to reflect knowledge of the world. Semantic memory held generic information that is probably acquired across many different contexts and is able to be used across many different situations. The term episodic memory, in contrast, was assumed to refer to the capacity to recollect individual events, for example, meeting of an old friend on holiday last year, or remembering what you had for breakfast. The essence of the episodic memory is its specificity, its capacity to represent a specific event and to locate it in time

and space. It is usually assessed with direct tests, such as recall and recognition and require from subjects intentionally retrieve information about a specific past processing episode. The neuropsychological evidence supports a clear distinction between semantic and episodic memory. Amnesic patients have a gross deficit in their capacity for storing new episodic memories in the absence of any obvious semantic memory deficit; they can use language normally and can answer questions about the world. However, this comparison involves contrasting new episodic learning with old semantic knowledge. Densely amnesic patients could have well-preserved episodic memories of incidents in their earlier lives, while would experience considerable difficulty in adding to their store of semantic knowledge. While the semantic and episodic memories could reflect different storage systems, perhaps relying on a common episodic input system, it can be assumed that semantic memory merely represents the residue of many episodes. But the assumption that semantic memory is simply the accumulation of episodes was challenged by the existence of the case of the young man who despite being amnesic from birth, has nevertheless acquired normal intelligence, language and semantic memory. Despite the general agreement that semantic memory served a different function and operated in a different way from episodic memory, there is disagreement as to whether the two depended upon fundamentally different learning and memory systems (Baddeley, 2001).

Disruption of episodic memory is attributed to cognitive failures of one type or another, including failure to encode sufficiently deeply, excessive sensitivity to interference between memory traces and failure to use environmental context adequately. The more basic neurobiological interpretation can be disruption of the function such as trace consolidation.

The feature of episodic memory that was increasingly emphasized by Tulving is the phenomenological experience of remembering. He referred it as the “autonoetic” character of episodic memory, with the recollective experience being regarded as a *sine qua non* of episodic memory. The term autonoetic (from the Greek word Gnosis) consciousness means awareness of subjective experiences in the past, present and future. Tulving suggested that there is differentiation as whether an item recognized or recalled is “remembered” or simply “known” by subject. “Remembering” requires the capacity to recollect some specific feature of the learning experience. The different types of consciousness associated with semantic memory and procedural memory are termed noetic (knowing) and anoetic (without knowledge) respectively. The capacity to “re-live” the experiences, associated with the initial episode, is crucial in allowing subject to reinvestigate his/her past and use it to predict future. It enables the individual mentally travel back into her personal past.

A crucial feature of the concept of episodic memory is the role of the rememberer, and the extent to which subject’s self concept is based on the accumulation of episodic memory. Distinction

can be made between the term “episodic memory”, which is limited to relatively recent recollective experience, and the longer-term accumulation of personal knowledge that is referred to as “autobiographical memory”.

3.2. Neuroanatomy of episodic memory.

Anatomically it seemed well established that episodic memory depended crucially on the hippocampus. But further research cast doubt on the earlier assumption of the simple and central role of the hippocampus. It was shown the need to assume a much more complex relationships between the various anatomical structures whose damage is classically associated with the amnesic syndrome in humans and impaired learning and memory in animals.

The lesion studies indicate that episodic memory depends on a network of cortical and subcortical structures, prominent among which are the hippocampus and adjacent medial temporal cortex (Daselaar et al., 2003; Casasanto et al., 2002; Davies et al., 2004; Desgranges et al., 2002) and the prefrontal cortex (Daselaar et al., 2003). The lesion of these regions gives different effects. The bilateral damage to the medial temporal lobe causes a severe, generalized impairment in the acquisition of new episodic memories and a more variable impairment in the recollection of events experienced pre-morbidly. It was found that left lateral temporal lobe regions involved in semantic memory also play a role in accurate episodic memory performance (Menon et al., 2002). By contrast, lesions of the prefrontal cortex give a limited effect on many tests of episodic memory, unless highly elaborate encoding or retrieval strategies are required. The prominent effects of prefrontal lesions are revealed on test that emphasize the retrieval of contextual features of prior events, such as when and where they occurred.

Findings from studies in which nonverbal as well as verbal items were employed showed that the prefrontal cortex is engaged during episodic encoding, and indicate that the lateralization of encoding-related prefrontal activity is material-dependent. Particularly right prefrontal region activation was found for episodic encoding of the non-verbal material (Baddeley et al., 2002; Dalla Barba et al., 1998).

Contribution of the medial temporal lobe in episodic memory encoding is more variable. Several studies found effects of the hippocampus in episodic encoding (Grön et al., 2003), whereas others didn't find such effects that can reflect the failure to employ contrasts in neuroimaging. It is widely held that a key role for the hippocampus during encoding is in some sense to “bind” together in memory disparate elements of a study episode. In some studies was found that the medial temporal lobe is sensitive to relative novelty. Retrieval-related medial temporal lobe activity has been reported in numerous studies (Baddeley et al., 2002).

Activation of the prefrontal cortex has been reported in the majority of functional neuroimaging studies of episodic retrieval (Cardebat et al., 1998; Ranganath et al., 2003). Even when the experimental material was verbal, retrieval-related activation often was right-lateralized. The right-lateralized prefrontal activation has been reported for free recall, word-stem cued recall, recall of paired associates and recognition memory (Baddeley et al., 2002).

Medial and lateral parietal regions have been consistently identified during episodic retrieval, usually including the precuneus region. Another parietal region consistently activated during episodic retrieval lies on the lateral surface of the parietal lobe including both inferior and superior regions (Daselaar et al., 2003).

3.3. Episodic memory in normal aging and dementia.

In contrast to memory for well learned life events, episodic memory tasks that measure memory for events occurring in the past few minutes, hours, or days, show more marked age deficits (Nilsson, 2003). It was found that in 16 year longitudinal study participants showed reliable declines in both text recall and word list recall, but not in recognition memory. It was suggested that text recall could be the most sensitive measure of the effects of ageing (Baddeley et al., 2002). It has been known that age-related declines in recognition memory are less severe than the comparable declines in recall. It was suggested that elderly have reduced processing resources which is explaining the differential effect of aging on recall and recognition. According to this view recall demands more attentional resources than do recognition. Age related decrements in performance of recognition tasks could be minimized because of high levels of environmental support, when the same item is presented at study and test. It should be noted that greater age-related decrement in recall than in recognition was not always found. Particularly when the difficulty of recall and recognition tests was equated, equivalent age-related losses were found in the two types of test (Baddeley et al., 2002).

Impairment of episodic memory is the earliest symptom and the core component of AD (Wilson et al., 2004; Lambon Ralph et al., 2003; Baddeley & Wilson, 2002; Caselli & Boeve, 1999; Perry et al., 2000) and is existed in the early preclinical period (Bäckman et al., 2001). The ability to learn and remember new information is a highly sensitive marker of dementia and a highly accurate method for differentiating mildly demented subjects form normal elderly. In the early stage of AD progression of the senile plaques and neurofibrillary tangles is occurred mainly in the mesial temporal regions, including hippocampal formation and related structures (Ghoshal et al., 2002; Garrido et al., 2002; Mauri et al., 1998). Among AD patients neuropathology has progressed to include perihippocampal temporal neocortex and to lesser extent the parietal lobe. It is likely that

disconnection of these brain regions from associated cortex is responsible for the episodic memory loss (Geula, 1998). Functional and structural neuroimaging shows the association between the damage of medial temporal lobe and episodic memory functioning in AD patients (Souchay et al., 2002; Bäckman et al., 2001). Episodic memory deficit is characterized to other forms of dementia, but qualitative differences of AD patients are high rate of intrusion errors and poorer performance of recognition tests (Baddeley et al., 2002). It was suggested that AD patients have deficit in the encoding of stimuli and any accelerated forgetting in AD occurs very soon after presentation of stimuli, thereafter the rate of loss is normal (Baddeley et al., 2002). According to study finding was suggested that AD and normal aging are not a continuum but are two well differentiated processes from both clinical and pathological perspectives (Wang & Zhou, 2002).

In several studies was found that VaD patients show better memory performance but poorer executive control and fewer intrusion errors than AD patients (Engstad et al., 2003; Kramer, 2002; Helkala et al., 1989). White matter abnormalities in VaD were associated with poorer free recall, whereas ventricular enlargement was related to poorer delayed cued recall compared to AD patients (Baddeley et al, 2002).

4. Working Memory Span

One of the challenges to the conception of a working memory capacity concerns how much of the capacity of STM is available as working memory during the execution of a task involving reasoning and comprehension (rather than just the recall of the presented information). When subjects perform such tasks, the reliable working memory capacity available for storage of information appears to be far below the magical number 7 and closer to 3 or 4 chunks. The form of trade-off between processing and storage is assumed to lead to individual differences in recall but the precise relationship between them and how cognitive resources are allocated between processing and storage remain unclear. It is not clear whether performance of the working memory tasks is best described as a trade-off between processing and storage within a general working memory system, or as the coordinated activity of separate processing and storage elements of a multi-component model of working memory.

There are different types of working memory span (WMS) measures but no one is generally accepted WMS measures (Baddeley et al., 1985). There are no pure WMS tasks. They differ in their dependent on materials and procedures used to perform task and on the extent to which they require controlled processing. Individual differences on WMS tasks also associated with individual differences in the domain-specific skills, abilities and strategies used (Miyake & Shah, 1999). These

span tasks are designed to resemble the working memory demands during performance of complex cognitive tasks by placing simultaneous demands on both processing and storage (Miyake & Shah, 1999).

In the present study, the most influential measurement of free capacity during processing, Daneman and Carpenter's (1980) reading span test was taken as a measure of the WMS (Baddeley et al., 1985). This task aims to combine simultaneously the need for storage and for processing. It measures subjects capacity of manipulate and maintain unrelated words in working memory during comprehension of a series of sentences. The task involved presenting subjects with a series of sentences which they are required to process at the same time as retaining the last word of each of the sentences. Performance is measured in terms of the maximum number of sentences that can be processed while correctly recalling last word. Both a strength and weakness of the WMS measure is its complexity. It involves a number of subcomponents, including comprehension, the selection and operation of strategies, learning, and recall. WMS generates impressive correlations with measures of language comprehension and other language-processing tasks. One of the functions of central executive is to access and manipulate information in long-term memory. Baddeley & Della Sala (1996) suspected that it is this function of the central executive that plays an important role in individual difference measures of WMS such as that developed by Denman and Carpenter in 1980.

Daneman and Carpenter (1980) suggest that this measure reflects the operation of executive processes in working memory, rather than of besides the functioning of the slave systems like the phonological loop alone. According to the working memory models assume a single cognitive resource pool used both for on-line processing and for temporary storage, the underlying assumption of working memory capacity, then, is that as memory demands increase, there is less capacity available for processing and vice versa. working memory capacity is a reflection of controlled attention functioning. It is not a storage or memory per se, but about the capacity for controlled, sustained attention in the face of interference or distraction. Thus individual differences on working memory capacity primarily reflect differences in capability for controlled processing and will be reflected only in situations that either encourage or demand controlled attention. It is argued that differences in working memory capacity correspond to individual differences in the functioning of the prefrontal cortex (Miyake & Shah, 1999). The "multiple resources" working memory models, like Baddeley's working memory model, assume that working memory incorporates cognitive subsystems each having a specialized function and that the degree of integration between the processing and storage components of the WMS task is not a crucial in determining the extent of any processing plus storage impairment, reflecting the relative

independence in operation of each specialized resource in working memory model that was shown by Duff & Logie (2001).

The dual-task performance is another “complex” task situation that requires the coordination of multiple components. Studying dual-task performance in the laboratory might be beneficial for our understanding of the role of working memory in real-world tasks (Miyake & Shah, 1999). The reading span task is a dual-task that requires the subject to do something separately and interleaved with this task, to keep track of an evolving and growing list of words. The span task apparently reflects some ability that is fundamentally important to higher-level cognition because measures of working memory capacity reliably predict performance in a wide variety of real-world cognitive tasks (Miyake & Shah, 1999).

5. Computerised version of the dual-task in AD patients

Memory impairment, as was noticed above, is one of the earliest symptoms of AD which reveal itself in problems of performance of laboratory test of memory and everyday memory functioning (American Psychiatric Association, 1994). Understanding of its nature can cast light on the cognitive and functional deficits of AD. Memory impairment of AD resembles that of the amnesic syndrome in showing impairment in the capacity of new learning and sparing of the recency effect of free recall. In AD access to semantic memory is impaired, retrograde amnesia and autobiographical amnesia is also frequently presented. In contrast, in amnesic syndrome the functioning of semantic memory is unimpaired as indicated by retained knowledge of word meanings and unimpaired speed of access to knowledge of the world; the capacity to recollect events from well before the onset of amnesia may also be relatively normal. The AD patients resembles the STM deficit patients since their performance is impaired on digit span, but AD patients differ from STM patients in exhibiting damaged performance on the Corsi non-verbal memory span task. It was shown that in contrast to STM patients AD patients show comparatively unimpaired performance on the recency component of free recall. The recency effect in AD would be less likely to be impaired as it is based on passive storage and is comparatively uninfluenced by concurrent load. It was suggested that AD patients show signs of using the articulatory loop since they exhibit presence of the effects of phonological similarity, word-length and articulatory suppression on span performance, while coupled with an overall impairment in immediate memory span. The AD patients showed impaired capacity to store information while simultaneously processing a heavy cognitive load that is assumed to be one of the functions of working memory depended on the central executive (Baddeley et al., 1986).

On the bases of research done on AD patients it was suggested that a deficit in the controlling central executive component of working memory can be characteristic of AD patients. This deficit may be lie at the root of many cognitive processing deficits of AD.

The central executive deficit in AD can be shown in the following examples:. a) AD patients showed difficulty in a dichotic listening paradigm, which requires the subject to concentrate on two simultaneous auditory inputs. This difficulty could be interpreted as a failure of the central executive to coordinate two sources of information. b) As was noticed AD patients were performing significantly more poorly than the controls in the primacy portion of the serial position curve, but both groups showed equivalent recency effects. It was shown that in the span tasks under dual-task condition which requires a demanding central processing capacity, primacy effect in free recall is disrupted and the recency effect is not disrupted by concurrent attention-demanding activities. According to these results were suggested that the recency-effect is not heavily depended on the operation of the central executive and therefore it is also one of the evidence supporting existence of the central executive deficit in AD patients. c) In Peterson and Peterson task subject is asked to retrieve verbal items from memory following short periods of distraction. In the AD patients' study using Peterson and Peterson task was shown that concurrent articulatory suppression caused substantial forgetting for the AD patients only. This could be due to excessive reliance of AD patients on articulatory rehearsal. It was hard to explain in terms of specific interference that even the tapping, a non-verbal distractor caused forgetting in AD patients. These findings showed that if the central executive capacity is reduced, even relatively simple tasks like tapping, can divert sufficient processing resources from maintaining subvocal rehearsal (Della Sala et al., 1992).

It was suggested that according to the working memory model the central executive is seen as coordinating the operation of two subsidiary slave systems and thus defective central executive in AD should have difficulty in coordinating the simultaneous operation of the two slave systems. This discoordination in AD should be reviled in dual-task performance (Baddeley & Della Sala, 1996).

In the first studies AD patients (Baddeley et al., 1986), young and old controls combined verbal processing task (digit span task) and visuo-spatial task - pursuit tracking in which subjects tried to keep a stylus in contact with a moving spot of light on the computer screen. The tracking task is not a pure spatial dynamic task in that it involves visual input and monitoring as well as motor control and movement. The task was adjusted by varying the speed of movement of the light spot so that equivalent levels of accuracy were achieved for AD patients, age and education matched healthy elderly and young subjects groups. In Baddeley et al. (1986) study three secondary auditory-verbal tasks were used: articulatory suppression, simple reaction time to a tone and digit span task. All four tasks were selected so that the amount of direct competition for specific

resources was minimised. It was suggested that articulatory suppression (repeatedly uttering the digits 1 to 5) would make minimal demands on the central executive and relies primarily on the articulatory loop and unlikely to produce substantial direct interference with tracking. But concurrent measurement for this task was not allowed. The simple reaction time to a tone is a relatively undemanding task that reflects the attentional capacity available to a subject and concurrent measurement for this task was allowed but it was not possible to control task difficulty across groups thus making difficult to argue against objection that the reaction time was simply more difficult for the AD patients than for the controls. The digit span task does make significant demand on both the central executive and the articulatory loop system, concurrent measurement for this task was allowed and it was possible to control task difficulty across groups. In the digit span task subjects repeated back sequences of numbers, with the length of sequences set so that the error rate was constant across the three groups.

In the study of Baddeley et al. (1986) was shown that AD patients were more disrupted than controls by the addition of a secondary task, even when the single tracking task was set at a comparable level of difficulty for AD and control subjects. It was found that in the case of articulatory suppression the dual-task effect was very small even for AD patients. Since was not undertaken the monitoring of the performance on the suppression task, it was not possible to rule out some form of differential trade-off between tasks and was not likely explanation of the difference between AD patients and controls. Performance on tracking while performing reaction time task showed a crossover interaction indicating that AD patients were more dramatically impaired by concurrent performance of reaction time task than were controls. The AD patients were more vulnerable to the demands of combining two tasks than controls on reaction time task also. However AD patients perform more poorly than controls when reaction time was studied alone. Thus interpretation of the reaction time performance impairment in AD patients was constrained and raised objections that the secondary task was simply more difficult for the AD patients than for the controls and adding a difficult task to tracing impairs performance more than adding an easier task. When digit span task was used as a secondary task while participants performed motor tracking, performance on each task was possible to equate for AD patients and controls. Under these conditions was observed an interaction between performance on concurrent tracking and subject group, coupled with an equivalent interaction between condition and subject group for the secondary span task. This experiment showed that when two tasks were equated between study groups for difficulty, their concurrent performance produced a disproportionately large decrement in performance for the AD patients. Young and old subjects performed these two tasks in a similar manner. Baddeley et al. (1986) interpreted received results as supporting the “central executive

deficit hypothesis". According to the "central executive deficit hypothesis" ("multiple resource theory") of AD, a central executive deficit should lead to an exaggerated impairment in performance when AD patients are required to coordinate performance simultaneously on two different tasks. The "multiple resource theory" suggests that in dual-task there is typically a "cost of concurrence", or a general processing load resulting from the requirement to co-ordinate the activities of two or more specialised resources, which is referred as an "executive time-sharer". This view bears a close resemblance to the central executive and the nature of the deficit in AD/pts. The "general resource pool hypothesis" ("single resource theory") assumes that the overall information-processing capacity or efficiency of patients with AD is reduced and anything that increases the demand placed on the patient will have an exaggerated effect on the performance of the AD group. The normal elderly have much larger resource pool and therefore have more spare capacity to cope with the demands of two simultaneous tasks. The dual-task performance in normal controls is depended on the nature of the individual tasks rather than upon their complexity.

It was suggested that when the tasks levels of difficulty are appropriately adjusted, then age per se does not influence the ability to combine two tasks. This result suggested that AD patients could have difficulty in integrating and coordinating two concurrent tasks. These results needed interpretation in respect of two issues: 1) was the performance on the separate tests between AD and control patients comparable and 2) whether results could be interpreted simply in terms of a limited general processing capacity being more taxed by more difficult dual task than by the individual tasks performed alone (*difficulty hypothesis*). According the *difficulty hypothesis* the dramatic decrement in performance of the AD patients under dual-task condition was due to simply because that performance of two tasks at the same time is more difficult that performance of one task and simply more difficult task differentially penalize AD patients. It may be general difficulty rather than time-sharing ability that underlies the observed impairment in AD patients. It was necessary to show incorrectness of this hypothesis. In this case concept of the difficulty could be specified. In the hypothetical experiment in which a primary task such as tracking is combined with two other tasks, A and B might be the case that when performed alone, A led to shorter reaction time than B, but when combined with tracking, it produced more impairment than B. According to the so called "difficulty hypothesis" could be argued that the "difficulty" is coming from the problem of combining tasks rather than from the difficulty of the task per se. This kind of suggestion arise the question as to how task difficulty might be defined independently of the observed level of performance. Tasks can be difficult in a wide variety of ways. There is no generally accepted definition of the concept of difficulty. However it was possible to devise single tasks that vary in the information processing load, but where it was reasonable to assume a minimal requirement for time

sharing. The level of information processing load was suggested as a strong candidate for a form of difficulty that was contrasted with time-sharing.

Baddeley et al. (1991) were retested on three occasions separated by intervals of 6 months AD patients and their age-matched controls studied by Baddeley et al (1986). In a longitudinal design each subject was his/her own control, hence avoiding some of the problems of comparability between patients and controls observed in earlier studies. It was suggested that if the “central executive deficit hypothesis” is a crucial, then dual-task performance would have produced an ever-greater deficit as the illness progresses and the dual-task performance would have been more sensitive for AD than a simple within-task increase in difficulty. In Baddeley et al. (1991) study computerised motor tracking task was combined with the same three concurrent tasks: articulatory suppression, reaction time on tone task and memory (digit) span task. In the memory span task performance was measured in terms of the percentage of list recalled completely correctly. Results of this study showed that articulatory suppression, concurrent reaction time and digit span tasks all disrupt tracking in AD patients and the extent of this disruption increases systematically over three successive tests separated by six months intervals. Healthy elderly group should consistently less influence of secondary task on tracking that was not increased over successive tests.

Articulatory suppression didn't have any impact on tracking in the healthy elderly participants. Even such an undemanding over-learned task as counting from 1 to 5, which had little influence on the visuo-spatial scratchpad, was sufficient to interfere progressively more with concurrent tracking as dementia progresses. The clear and systematic decrement in performance under dual-task condition using concurrent simple reaction time was found for AD patients. This same deterioration over time didn't appear reliably for single task performance. As it could be argued that articulatory suppression and concurrent reaction time task became progressively harder as the patient deteriorated, the third condition was crucial. The digit span was adjusted so as subjects were performing at an equivalent level on each of the three testing sessions. In this condition, the decrement under dual-task condition was consistent and progressive for AD.

The difficulty hypothesis was studied in different experiments. The adaptation of constituent tasks' level of difficulty is an appropriate control for the effects of general processing load. Baddeley et al. (1991) addressed the difficulty hypothesis by studying the effect of difficulty level on a categorization task in a cross-sectional and in a longitudinal designs. It is known that categorization becomes increasingly difficult as the number of categories from which a target is selected increases, where difficulty is measured by error rate and reaction time. Increasing number of alternative categories is known to increase difficulty as measured by response latency. This increase is probably due to slowing of semantic memory access, a process that does not appear to be

heavily dependent on working memory capacity. *Categorisation task.* In the categorisation task subject was presented with a category, for example labelled animal, and an instance which may or may not belong to the target category, for example dog or apple. The subject's task was to press a key with his or her preferred hand only when the item presented belonged to the target category. The name of the target category was displayed in the centre of a computer screen. The text comprised three conditions. In the first condition only one category was presented and the items were drawn from two categories, one of which was the target category. Condition two was a more complex version of the same task, where the number of categories was increased to two, displayed side by side in the centre of the screen. Finally, four target categories were displayed in a row and the items were drawn from a pool of eight categories. Performance was measured both by accuracy and by response times. In Baddeley et al.(1991) study, AD patients showed that the patients clearly deteriorated over time, and performance was poorer with a larger number of categories. The crucially important was the fact that there was not find any tendency for these two variables to interact. These results meant that there was no tendency for performance on the more "difficult" four-category task to deteriorate faster than performance on the "easier" one-category task. The lack of a "difficulty" effect over time undermined the interpretation of the dual-task findings in terms of task difficulty and made more plausible the interpretation of a deficit in an executive time-sharer impairment perspective.

Baddeley et al. (1991) suggested that if the greater impairment for AD patients on dual-task is explained in terms of the general difficulty of the task, then it would be expected AD performance on the most difficult version of the categorization task to deteriorate over time, much more so than for the easier version of the task. If dual-task coordination is the crucial deficit, there was no reason to expect within-task difficulty to show the marked increase over time. Elderly subjects showed little if any drop in performance of categorization task, when level of difficulty was increased. Their performance was stable over time. AD showed significantly poor performance when number of categories was increased and performed significantly poorer than controls, but there was not found interaction in deterioration of performance over time and increase of task difficulty. This lack of an interaction of task difficulty with time in AD patients indicated that AD performance deterioration under dual-task condition couldn't easily be explained only in terms of task difficulty such as digit span, or verbal reasoning, but had little effect on visuo-spatial tasks such as pursuit tracking or tests of spatial manipulation. The lack to find interaction between task difficulty and disease progression in the Baddeley et al. (1991) study provided evidences against correctness of the "general resource pool hypothesis". According of these results was suggested that the progressive deterioration in performance shown by AD patients is not a function of simple level of task difficulty but is

depended on whether single or dual task performance is required. The results of discussed studies on AD showed that the “executive time-sharer” is dramatically impaired in these patients, and the operation of the executive time-sharer deteriorates further with the progression of the disease. Since normal ageing does not lead to a substantial impairment in the time-sharing ability, this deficit seems to be associated specifically with AD. Cocchini et al. (2002) study demonstrated that combining even two very demanding memory tasks does not yield consistent reduction in performance and can be performed concurrently with minimal interference in healthy controls. Retention of a digit preload was not disrupted by an interpolated visual memory task, and retention of a visual pattern preload was not disrupted by interpolated digit recall. No significant disruption of a digit span was found by preload of an interpolated tracking.

Logie et al. (2004) used more refined and systematic experimental designs to test difficulty hypothesis. The impact of dual-task performance of AD patients, healthy young and elderly participants were studied in a) low demand condition; b) in single task with high demand condition; and c) in dual-task condition when the demand of one task was fixed while the demand of the other task was varied, thereby allowing spare capacity for secondary task demand.

a) A general attentional hypothesis might suggest that impairment occurs in the AD patients because their overall capacity is exceeded to a much greater extent than that of healthy adults solely by the additional demand imposed by dividing attention between two tasks. Logie et al. (2004) suggested that if the difficulty hypothesis is correct, then reducing the level of demand of the component tasks might take the overall load below the point at which dual-task performance causes impairment. AD patients typically perform more poorly than healthy elderly participants on single tasks, raising the possibility that group differences detected under dual-task condition could arise as artefacts of the differences in single task baseline performance. Therefore Logie et al. (2004) studied dual-task performance both at an individual titrated level of demand and at a level in which demand of both tasks was markedly reduced relative to each participant’s ability. Logie et al. (2004) replicated previous findings (Baddeley et al., 1986) detecting dual-task impairment in the AD patients that was not present in the healthy elderly participants. In the low-demand condition AD patients also showed significant decrement on the combined dual-task measure in comparison to the control groups.

b) To investigate more deeply the difficulty hypothesis, Logie et al. (2004) studied only single tasks (digit span and perceptuomotor tracking) at five different levels of demand covering the range below (very low demand, low demand), at (standard) and above (high demand, very high demand) the level assessed for each individual and for each task in three study groups (AD patients, healthy young and elderly controls). It was assumed that if observed AD deficit under dual-task condition

stemmed from a general limitation in processing capacity, then they would show an increasing divergence from control performance as the level of difficulty of the single task increased. The experiment showed very similar effects on performance of a systematic increase in demand in either the tracking task or digit span task for all three groups. There was no evidence of a differential impairment in the AD patients that provided no support for the hypothesis that simply increasing level of task demand would differentially impair AD patients' performance in the absence of the requirement to divide attention. According to the Logie et al. (2004) the performance of two low demand tasks resulted in a specific impairment in the AD patients, and this function is specifically impaired in AD patients.

c) In this study one more sensitive design was used to study a possible interaction between task demand and divided attention by fixing one task demand while varying the other task demand under dual-task condition. It was suggested that if the manipulation of the demand on one task would have little or no impact on performance of the concurrent task in controls or in AD patients, then could be confidently assumed that dual-task cost and overall cognitive demand posed by each task are supported by separable components of the cognitive system in both the healthy and the damaged brain. For the AD patients, if their dual-task decrement stemmed from a general limitation in processing capacity, then it would be apparent as the load on the two constituent tasks increased. But if the deficit occurred because of a specific difficulty in dual-task combination, then the effect would be remained constant across levels of demand for each task. Logie et al. (2004) study showed an overall reduction in performance for all three groups with increasing task demand. Again, AD patients showed a disproportionate degree of decrement. There was no interaction between dual-task demand and dual-task decrement. These results were inconsistent with both a simple overall capacity interpretation and with the proposal of an interaction between dual-task performance and level of load.

If central executive and long-term memory deficits were separable in AD patients, than it should be possible to identify two individuals: one a pure amnesic and other a pure dysexecutive. It was shown that when retesting AD patients who were previously classified as amnesic, part of them at retest didn't show amnesic symptoms, but were classified as having dysexecutive syndrome. Those patients who showed disexecutive syndrome, at retest part of them didn't show disexecutive pattern but became amnesic. It was suggested that in a progressive disease such as AD, the dysexecutive syndrome and the amnesic syndrome may reflect a transitory phase in the progression of the disease and cognitive impairment in AD is presented in a wide heterogeneity (Della Sala et al., 1992). Sample of demented patients usually shows the heterogeneity of cognitive deficits. Each patient differs quite widely from each other in their precise pattern of cognitive deficits and other

deficits typically appear as the disease progressed. The fact that AD patients showed an apparently coherent pattern of impairment under dual-task condition, possibly reflect the nature and distribution of the underlying pathological processes (Baddeley et al., 1991).

The deficit of the dual-task performance may not be unique to AD. It might well be the characteristic of other forms of dementia or other conditions resulting from brain damage leading to similar impairments. Nonetheless dual-task measure proved its sensitivity to the progress of the disease and in discrimination of the effects of AD from the normal processes of ageing which does not lead *per se* to a substantial impairment of the time-sharing component of working memory as was shown from different studies. It appears to be a valuable measure in both detecting of AD and monitoring its progress.

5.1. Effect of normal aging on dual-task performance.

Combining two tasks, both of which show an age effect, will inevitably give as a result an age effect on dual-task performance, what is happened in the studies where groups are not matched on initial levels of performance on the individual tasks. The age effect on dual-task was detected also in the studies even when the consistent tasks are matched for level of difficulty across groups, but such age effects are not as robust as the consistent dual-task decrement in AD patients.

In the study of Baddeley et al. (1986) was found evidence that combined dual-task impairs performance for both the young and elderly subjects, together with some evidence for general age effects on performance, but no suggestion of an interaction between age and secondary task. In this study young participants had higher education level and hence might be expected to have some advantage over the elderly, beyond that afforded by differences in age, but little or no differential disruption of performance between these two groups was observed. It could happen because the difficulty levels of the various tasks were successfully equated for study subjects. Examining of the motor tracking data indicated that the elderly achieved the criterion tracking performance at a reliable lower difficulty level that did the young and they also showed longer mean reaction time than the young, that means that the elderly and the young do differ in cognitive capacity, but when performance on the two concurrent tasks is equated between young and elderly, then combining them does not lead to any greater decrement in the elderly than in the young.

A number of studies have demonstrated that healthy adults can perform under demanding dual-task conditions with very little performance degradation on either task relative to single task baseline levels (Baddeley et al., 1986; Baddeley et al., 1991; Della Sala et al., 1995), but in other study no dual-task decrements were found (Duff & Logie, 2001; Verhaeghen et al., 2003). The relative lack of dual-task disruption was associated with the operation of a multiple-component

working memory system which offers online processing and temporary storage of information by means of the subcomponents (Baddeley, 1986). In normal subjects the substantial impairment of performance under dual-task condition is determined by the choice of the type of task that are combined, and not by the overall cognitive demand of dual-task requirements (Logie et al., 2000).

6. Paper and pencil version of the dual-task in AD patients

The studies on AD patients using computerised dual-task method proved its effectiveness in detection of central executive deficit of AD. The computerised tracking task was problematic to use since it requires a light pen that is not a standard piece of most people's laboratory equipment, together with a program which was found didn't readily transfer even to other computers that were nominally identical. It was began the search of paper and pencil alternative of the computerised tracking task. After a long search eventually was developed a task in which the subject was required to place a cross in a chain of boxes arrayed on a response sheet. Having practised the task, subjects were required to fill as many boxes as possible in two minutes. The digit span task then involved selecting a length at which the subject recalled the sequence virtually perfectly, followed by a two minutes test run in which tasks were performed simultaneously (Della Sala et al., 1995).

In Della Sala et al. (1995) study paper and pencil version of the dual-task was validated on 12 AD patients and 12 controls. The digit span memory task was used as verbal task for the paper and pencil version of the dual-task. Della Sala et al. (1995) encountered a number of problems while devising a portable paper and pencil alternative of the computerised dual-task. They attempted to use different forms of the tracking task like tapping task based upon Fitts' law (Mendelsohn, 1995) and Mazes, but after careful piloting and search both of these tasks were abandoned. In paper and pencil motor task subjects were required to cross out, by a flat pan, 1 sq cm boxes linked to form a path out on an A4 sheet o paper. All subjects first performed practice trails using a 10-box path, until the examiner was reassured that they had understood the task. Each experimental sheet had 80 boxes. The subjects were asked to start at one end of the chain and place a cross in each successive box as rapidly as possible. The paper and pencil tracking task had no adaptive phase for adjusting difficulty level to each individual's ability. It had practice trial to accustom participants to the procedure and included single and dual conditions. If subjects managed to cross all the boxes before the time limit of two minutes had elapsed, then a second sheet was presented. The total number of crossed boxes was taken as the score. This paper and pencil task was used for single motor tracking task and dual-task condition. All AD patients showed a decrement in span task when combined with tracking. Della Sala et al. (1995) study replicated the findings of Baddeley using a paper and pencil

version of the dual-task. Tracking performance showed a similar but less clear cut tendency for greater dual-task decrement in AD patients than in controls, which didn't reach significance. The paper and pencil version of the dual-task showed its sensitivity in detecting AD cognitive deficit while at the same time was relatively insensitive to the normal effects of ageing.

Green et al. (1995) used the same paper and pencil version of the dual-task with minimally and mild impaired AD patients and age-matched controls. The clear tendency of dual-task decrement was found for AD patients. They found that the performance on the paper and pencil version of the dual-task was correlated with scores on another, quite different dual-task. In contrast to the AD patients in Della Sala et al. (1995) study, principle decrement was found on the tracking task. It was suggested that one reason for this discrepancy in dual-task result could be differences in strategies used by different individuals, in varying aetiologies and rapidity of fatigue onset within sessions. The other possible account of this fact offered by Logie et al. (2004) is that in the case of digit recall, the participants have to respond orally to an experimenter, making their impairments in performance salient to another individual. Performance on tracking is recorded by a computer, and AD patients may feel that their poor performance on tracking is less obvious to the experimenter. Patients in the early stages of AD are aware that they have cognitive problems, and they may wish to give the experimenter the impression that they can still perform at a reasonable level. This can motivate them or their caregivers to agree to participate. Indeed AD patients performed at a reasonable level under single task conditions and could approximate single task conditions when faced with a dual-task demand by focusing on one task rather than the other. This reinforced the value of using a combined measure of changes in both tasks.

The mild decrement in performance was shown in Parkinson's patients and in patients suffering from traumatic brain injury using paper and pencil version of the dual-task. This test proved to be a useful in differentiating frontally lesioned patients from hippocampally damaged patients (Badeley et al., 1997). The new paper and pencil test appeared to be more sensitive than "frontal" tests to behavioural changes arising from frontal lobe damage. It proved to be sensitive in differentiating patients with dysexecutive syndrome from non- dysexecutive patients, in comparison with the classic "frontal" tests like fluency and the Wisconsin Card Sorting Test (Della Sala et al., 1995; Della Sala et al., 1997).

6.1. Combined dual-task *mu* score

It is possible that AD patients don't demonstrate a statistically significant difference from controls on any single one of the component tasks under dual-task (computerised or paper and pencil version) condition, thus highlighting the need for a score that combines both of the concurrent tasks. Interpretation of the dual-task findings is complicated by the fact that different subjects may choose to distribute their attention differentially across the two subtests. Participants may decide either to perform both tasks to the best of their ability, or to concentrate on one at the expense of the other (Della Sala et al., 1995; Green et al., 1995). The single dual-task performance index, which would take into account both component tasks, so that if participant A, while equalling participant B on, say tracking, has a much lower score on memory, A would be assigned a lower overall performance score than would B. Deriving of combined dual-task score is likely to depend on the assumptions underlying the method of combination and should be based on the detailed analysis of the processes underlying performance at different levels of difficulty, together with an understanding of the process involved in combining them. Since such analysis is not available at the present, combined dual-task *mu* scores are used for assessment of performance under dual-task conditions (see page 66).

The definition of a single dual-task index was determined also by the psychometric considerations of the clinical assessment of an individual patient, as opposed to the making of a comparison between groups. The reliability aspect of the combined dual-task measuring instrument was studied to define if individual could achieve a similar score if tested again. For a test to become useful in a clinical setting, dual-task needed to be able to determine whether an individual's score on a test is such that there is reason to suspect the presence of functional impairment. Thus it was necessary to find a cut off scores to arrive at a region of performance, which should alert the clinician to the possibility of brain damage. All of these issues were studied by Baddeley et al. (1997) on paper and pencil version of the dual-task, investigating statistical behaviour of a composite measure of dual-task in healthy adults taking into account such demographic variables as age, level of education and gender. It was found that the distribution of *mu* scores were symmetrical, approximately normal. There was small and insignificant correlation of *mu* with age. Distribution for men and women were not different. The *mu* score was constructed so as not to reflect the individual's digit span, which was confirmed by the study results. Della Sala et al. (1997) study found very low reliability for *mu* scores that could be determined by the size of the sample and procedural aspects of the dual-task method, and that made interpretation of the *mu* scores less straightforward.

In general can be concluded that results received by the computerised version of the dual-task was replicated by the paper and pencil version of the dual-task that proved at one hand the robustness and generality of the AD deficit to combine two tasks, but on the other hand it showed to be the comparable counterpart of the computerised version of the dual-task to detect such deficit. The paper and pencil version of the dual-task had proved to be convenient for clinical use, but it needs further refinement to achieve its full potential as the clinical measuring instrument.

7. Standing of research problem

The central executive is the less well studied component of working memory. One of the important functions of it is the ability simultaneously coordinate two tasks. As was shown above the failure of this coordination is a characteristic impairment of patients with mild AD both in a laboratory setting (Baddeley et al., 1986; Della Sala et al., 1995; Greene et al., 1995; Baddeley et al., 2001; MacPherson et al., 2004) and in everyday tasks (Alberoni, et al., 1992), but not presented in normal elderly controls. There is now a considerable body of evidence showing that deficit in attentional functioning is an important feature of cognitive deterioration in AD (Balota et al, 2001; Della Sala & Logie, 2001; Spinnler, 1991; Baddeley et al., 1999). The deficit of the dual-task performance may not be unique to AD. It might well be the characteristic of other forms of dementia

Vascular disease of the brain is a widely distributed disease in the population of the world. Cerebrovascular disease is the second most common cause of acquired cognitive impairment and dementia and contributes to cognitive decline in the neurodegenerative dementias. The incidence of vascular disease of the brain and its cognitive causes are perhaps preventable and appears to be declining as a result of identification and treatment of many of the major risk factors. Thus early detection and accurate diagnosis of vascular cognitive impairment and VaD is a challenge (Bowler et al., 1995). In the broadest sense, VaD refers to impaired cognitive function that has been caused by cerebral injury secondary to different forms of vascular disease. VaD is a controversial entity viewed differently by clinicians, neuroradiologists and neuropathologists. The current narrow definitions of VaD should be broadened to recognise the important part cerebrovascular disease plays in several cognitive disorders (Bakchine & Blanchard, 2005; Lawrence, 2000; Korczyn, 2002; Schmidtke & Hüll, 2002; Hachinski, 1997). VaD is characterised by a specific cognitive profile involving preserved memory with impairments in attentional and executive functioning (Garret et al., 2004; Markesbery, 1998; Sachdev et al., 2004; Laukka et al., 2004; O'Brien & Lilienfeld, 2002; Erkinjuntti, 2002).

Clinical trials in vascular cognitive impairment are in their infancy but support the value of therapeutic interventions for symptomatic treatment (Mendelsohn, 1995). As was shown in several studies (Balota et al, 2001; Della Sala & Logie, 2001; Spinnler, 1991) dual-task performance is a highly sensitive measure of cognitive decline in patients suffering from AD but not yet studied in VaD patients, which is the aim of the present study.

One of the problems in the treatment of dementia is the need to detect it at an early stage. Whatever the underlying cause of dementia, it seems likely that any treatment that is devised will be most effective if provided during the early stages, before the occurrence of profound neural and intellectual deterioration. Thus it is important to develop tests those are sensitive to dementia and capable to differentiate patients with dementia from normal aging.

Dual-task paradigm proved to be the sensitive tool for detecting of cognitive decrement in early stages of AD, while being relatively impervious to the effect of normal ageing, but it is still not investigated in VaD patients. Investigation of the central executive processing in VaD will broaden the current narrow definitions of VaD to recognise the important part cerebrovascular disease plays in several cognitive disorders. There is a pressing need to validate and further refine diagnostic tools and criteria. It is essential to make the dual-task method (Della Sala et al., 1995; Della Sala & Logie, 2001; Hartley et al., 1999; Logie et al., 2000; Garcia-Villamizar & Della Sala, 2002) available in a user-friendly form for clinical settings.

Distinction of VaD and AD on neuropsychological tests remains controversial. Some studies showed superior performance of VaD patients on episodic memory and more impaired executive functioning compared with AD patients, when groups of patients matched on age, education and severity level of dementia were studied (Looi et al., 1999; Desmond, 2004; Kitabayashi et al., 2001; Cannata et al., 2002). There are a range of executive functions, which may be differentially impaired in VaD and AD. There are also studies according which AD and VaD have many shared pathological, symptomatic, neurochemical features (Kalaria, 2002) and executive functioning can be a shared pathology for AD and VaD (Voss & Bullock, 2004; Graham et al., 2004). It still remains unanswered which cognitive domain is specific or common to the different types of dementia. The present study aims at making contribution in answering the multi-facet question of cognitive impairment of different types of dementia.

8. Objectives of the study

Objectives of this study are:

To study mechanisms of cognitive disorders characterized to VaD, particularly

- a) Functioning of central executive component of working memory;
- b) Refinement of clinical diagnostic criteria and methods for VaD in the context of the structural dynamics of memory degradation.

9. Tasks of the study

Tasks of the present study are:

1. To study one proposed central executive component of the working memory model (Baddeley, 1986; Miyake & Shah, 1999) namely the capacity to combine two concurrent tasks (dual tasks) in VaD patients, aged-matched and young control subjects. In the study it will be determined whether VaD patients will show the similar marked decrease in performance levels on one or both single tasks, when it is required to combine them as was shown by patients suffering from dementia of the Alzheimer Type (AD) (Baddeley et al., 1996; Della Sala & Logie, 2001; Logie et al., 2004; McPherson et al., 2004).
2. To compare effects of computerised (Baddeley et al., 1996) and paper and pencil (Baddeley et al., 1997; Della Sala et al., 1995) version of dual task performance in Vascular Dementia patients, aged and education matched elderly persons.
3. To show whether WM capacity (Working Memory Span) determines performance on dual-task paradigm and whether the relationship between WM capacity and dual-task performance is different for VaD patients, healthy young and elderly persons.
4. To show whether there is differential disturbance of episodic memory performance and central executive functioning, particularly performance on dual-task paradigm in VaD patients.
5. To prepare adapted version of the cognitive test batteries and define norms for Georgian population.

Experimental Section

10. Methods and participants

10.1. The tasks used in the present study.

10.1.1. The computerized version of the dual-task

In the computerised version of the dual-task study participants were performed the List Memory Task – serial digit recall verbal task and a computerised version of the perceptuomotor tracking task singly and in a dual-tasks paradigm whereby the two individual tasks are performed simultaneously.

List Memory Task. Participants listened to lists of digits from a computer and repeated the digits in serial order. All nine digits (1-9) were recorded by a professional TV speaker and after using computer program Cool Edit Pro 2.0 and Superlab 1.03 were randomly combined in lists of digits of different length. In each list digits were presented at a rate of 1 per second. In the Digit Span Determination participants were tested on six lists of the same length, starting with length 2. Participants' digit span was determined as the maximum length of the lists of which the participants recalled at least 5/6 correctly. In the List Memory Single Task each subject immediately repeated back the lists, the length of which was equal to the subjects span during 2 minutes. Two different scoring procedures were used for the final score of the List Memory Task. According to the first scoring procedure raw scores (the number of digits recalled correctly in their serial positions in each list) were converted to proportions by using a conversion table (see Appendix Table 1.) or simply dividing them by the length of the list (the term "digits recalled correctly" will be used in the remainder of the thesis). The participant's final score was the mean proportion that is the total of the converted proportions divided by the number of lists dictated. Using the second rule of scoring number of correctly recalled lists was divided by the number of lists presented (the term "lists recalled correctly" will be used in the remainder of the thesis) (Cocchini et al., 2002).

Motor Tracking Task. A target comprising a red oval with dark spots about 2.5 cm long and 2 cm wide was shown on a computer screen to the study subjects. This stimulus resembles an insect known as a "ladybug" in North America and known as a "ladybird" in the UK. Subjects were given a light-sensitive stylus that they placed on the target which then began to move randomly around the screen. The task requires keeping the stylus placed on the moving Ladybug the speed of which could be set at different levels. At the speed level 1 the target was moved approx. 3.5 cm per second. Different speed levels of the target differed from each other by 1 cm per second (speed level 2 – 4.5 cm per second, speed level 10 – 12.5 cm per second). The target remained red as long as the stylus was in contact, but changed to green when contact was lost and returning to red when contact was regained. The monitor screen was placed at an angle of 30 degrees from horizontal,

because in previous studies it was found that this angle is less physically tiring than using a vertical screen. In the adaptive tracking test the Ladybug moved slowly at speed level 2 = 4.5 cm per second. The speed level increased to the next level if, over a period of 5 seconds, the participant maintained contact with the target for at least 60 % of the time. If time on target was less than 40 %, the speed level was reduced to the level below. If time on target was between 40 % and 60 %, the speed level did not change. When the speed level remained constant for 15 seconds – three 5 second periods, the adaptive tracking phase was complete, and this speed level was used as a measure of the tracking ability for the individual. To avoid fatigue from a lengthy adaptive tracking phase, speed level changes at the lower level involved single steps from 1 to 5, whereas higher speed levels involved changes of two steps at any given time. This also allowed for lower ability people to have a reasonable amount of practice, but at the same time higher ability subjects would not perform a dramatically larger number of trials, which would possibly result in substantially different levels of practice according to individual ability (Cocchini et al., 2002).

The Dual-task condition. In the dual-task condition subjects performed the tracking task while simultaneously verbally reproducing lists of digits.

Subjects performed the Digit Span Determination procedure, then List Memory (Single Task) Task, then computerised Tracking (Single Task) Task, followed by computerised dual task (digit span plus motor tracking), then retest of computerised dual task.

10.1.2. The paper and pencil version of the dual-task

In the paper and pencil version of the dual-task study subjects were performed the List Memory Task – serial digit recall verbal task and paper and pencil version of the perceptuomotor tracking task singly and in a dual-tasks paradigm whereby the two individual tasks are performed simultaneously.

List Memory Task. The same serial digit recall task used for the computerised version of the dual-task was used for the paper and pencil version of the dual-task.

Paper and Pencil Motor Tracking Task. In previous dual-task studies (Baddeley et al., 1997; Della Sala et al., 1995) using paper and pencil version of the perceptuomotor tracking 328 circles with diameter approx. 9 mm and joined together in a chain were randomly distributed on A3-sized paper (Figure 2a). Participants were required to use a felt pen to cross out circles from the start circle to the end, as indicated on the test sheet. They had to place a cross on each successive circle as quickly as possible. Participants were first given a number of practice trials with a short, 35-circle path presented on an A4-size paper, to accustom them to the procedure, and to ensure that

they had understood the task requirements. The score of the motor task was the number of circles successfully marked by the participant.

The Dual-task condition. In the dual-task condition participants performed the tracking task while simultaneously verbally reproducing the lists of digits.

10.1.3. The pilot study.

Participants

37 healthy controls, of whom 18 young (8 - male, 10 - female) and 19 old (8 - male, 11 - female) participated in the pilot paper and pencil dual task study. The mean age of the young was 18.89 years ($SD = 1.28$, range = 17-21) and they had a mean of 12.89 years of education ($SD = 2.03$, range = 7-17). The mean age of elderly subjects was 64 years ($SD = 6.58$, range = 50-72) and they had a mean of 15.68 years of education ($SD = .75$, range = 14-17).

Four VaD patients were subjected to the pilot study. Two VaD patients were recruited from the Dementia Department of the Tbilisi Psychiatry Institute, with diagnosis of VaD established on neurological assessment and history of disease without having the MRI or CT visualisation. Another 2 VaD patients were recruited according to the patients' history information received from the two different neurology departments of the two different clinics in Tbilisi. The MRI study results were available for these two patients. Their disease history, risk factors and neurological signs were investigated. The NINDS-AIREN criteria and diagnostic tool ICD-10 were used to establish diagnosis of VaD. The mean age of VaD patients was 71.5 years ($SD = 2.12$, range = 70-73) and they had a mean of 16 years of education. The mean MMSE score for patients was 15.5 ($SD = 3.59$).

Tests

The List Memory Task and paper and pencil version of the perceptuomotor tracking task used in previous studies (Baddeley et al., 1997; Della Sala et al., 1995) was conducted on 37 healthy controls and 4 VaD patients singly and pairs of tasks in concert.

Results

Controls performed paper and pencil motor tracking task properly and could follow the random pattern of circles' distribution crossing them in consecutive order, while 3 out of 4 VaD patients encountered problems in task performance. In the dual-task situation patients began writing numbers they heard inside the circles instead of crossing them. Another problem was the difficulty to follow the random track of circles. It was proposed that VaD patients may have prominent

attentional problems resulting in failure in the task performance. Based on this logic a new, modified, simpler version of the task was developed, which was named “Tbilisi paper and pencil motor task”.

10.1.4. The “Tbilisi paper and pencil motor task”.

A modified version of the paper and pencil version of the motor tracking task was developed. Instead of circles, use of filled black arrows was devised to prevent writing numbers inside. Arrows also indicated direction to move on and were arranged in vertical parallel lines instead of random trajectory. Participants were presented with 373 black arrows linked with each other and forming path laid out on an A3-size sheet of white paper (Figure 2b). Height of the tip of each arrow was 5 mm and length of each base was 7 mm. Straight lines linking arrows were 1 cm in length. Subjects were required to use a felt pen to cross out arrows from the start arrow to the end, as was indicated on the paper. They place a cross on each successive arrow as quickly as possible. Number of arrows was chosen in pilot trials so that it was impossible to cross all arrows in two minutes. Participants were first given a number of practice trials with a short, 35-arrow path presented on an A4-size paper, to accustom them to the procedure, and to ensure that they understood task requirements. The score of the motor task was the number of arrows successfully marked by the participant.

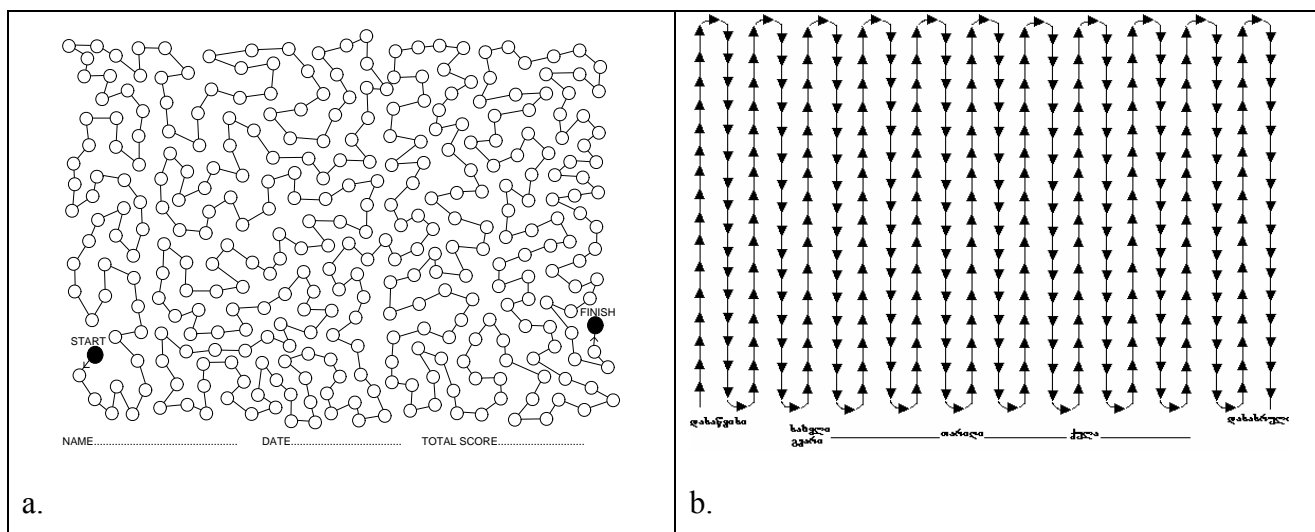

Figure 2. Pattern of figures (arrows and circles) for motor tracking task. a) The old version of the motor tracking task; b) “Tbilisi paper and pencil motor task”.

The same participants were retested using the new version of the paper and pencil motor tracking task. All VaD patients except one performed the task requirements correctly. Further experiment on other VaD patients recruited in the study showed no more problems in performance of the new motor tracking task.

10.1.5. Memory tasks

10.1.5.1. The working memory span task.

This task was based on the technique used by Daneman and Carpenter (1980). The subject heard a series of short sentences, each involving a subject performing an action, a verb, and an object for example, *Doctors have a profession*, or *Asia is a continent*. Study subjects heard two, three, or four sentences and then were asked to recall the last words of sentences in any order. In order to ensure that the subject comprehended the sentences and didn't merely treat the task as one of verbal memory, they were required to categorize each sentence on the basis of whether or not it made sense. Half the sentences were sensible and half were absurd (for example, *Ants are living creatures* and *Florida is a parent* respectively). After the subject had heard each sentence they responded orally 'true' or 'false'. The test successively involved 3 sequences comprising 2 sentences, 3 sequences with 3 sentences, 3 sequences with 4, 5 and 6 sentences (total of 60 sentences). Subjects were given examples and practise trial with 2 sentences. Presentation of sentences was continued until the participant failed on two or more sentences at a given sequence length. The three longest correct sequences are then taken as the basis for Working Memory Span. For example, with 2 correct sequences of 5 sentences and three correct sequences with 4 sentences, subject's span would be $(5+5+4)/3=4.67$. English versions of sentences were translated in Georgian and adapted to culturally accepted forms in pilot studies by expert language specialists and psychologists. 5 different lists of 60 sentences were prepared. For each participant a list was selected randomly from a set of 5 lists.

10.1.5.2. The episodic memory tasks.

The Georgian versions of the Wechsler Adult Intelligence Scale - III (WAIS-III) and the Wechsler Memory Scale – III (WMS-III) were prepared with assistance from professional psychologists and Georgian language specialists. These two test batteries were piloted on the same aforementioned 37 healthy controls and 4 VaD patients. The two episodic memory tasks were chosen from the WMS-III according to the study objectives: the Verbal Paired Associates (VPA) task and the Word Lists Learning (WLL) task.

10.1.5.2.1. The Verbal Paired Associates task.

In this task the novel word associations were orally presented to the subjects. The word pairs were selected based on number of syllables and are high imagery words. Subjects were tested under immediate recall and under delayed recall conditions. In the immediate recall condition after 8 word pairs are read, the first word of each pair was then given, and the subject was asked to provide the

corresponding word. 4 trials of the same list in different orders were presented to participants. The subjects were prompted to remember the presented list because they would later be asked to recall the list. The delayed recall was administered 30-35 minutes after immediate presentation. In the delayed recall condition subjects were orally presented with the first word of each pair learned in the immediate condition and asked to provide the corresponding word. Each correct response was scored 1 point and 0 point was scored for each incorrect response. Recall total score for each trial was the sum of the scores for 1-8 items of the verbal paired associations. The score range for the recall total score was 0 to 8 points. The trial 1 recall total score was subtracted from the trial 4 recall total score to find the learning slope for the verbal paired associates. The score range for the learning slope is -8 to +8 points. The percentage retention after delay was calculated as division of the delayed recall total score by the trial 4 recall total score and multiplying the quotient by 100. If the score is greater than 100, it is rounded down to 100. When the trial 4 recall total score was 0, the percentage retention score was set to 0. The score range for the percentage retention was 0 to 100% (Wechsler, 1998).

Intrusions – contaminations, confabulations and perseverations were carefully recorded verbatim for the study participants in each immediate trial and in delayed recall condition. The number of intrusions made by participants was counted for each of three types of intrusions. The average of these three types of intrusions was taken as an individual error score for the Verbal Paired Associates' task. Contaminations in this task means either incorrect pairing of proper word pairs in the trials 1-4, or inclusion of the Word Lists task's words in the delayed recall trial of the Verbal Paired Associates' task.

10.1.5.2.2. The Word Lists Learning task.

In this task participants were tested under immediate recall and under delayed recall conditions. In the Word List Learning task a list of 12 semantically unrelated words was orally presented and the study subjects were asked to recall as many words as they could. This process was repeated over 4 learning trials. The subjects were prompted to remember the presented list because they would later be asked to recall the list. The delayed recall was administered 30-35 minutes after immediate presentation. In the delayed recall condition participants were asked to recall the first list learned in the immediate condition. The number of the correctly recalled words was taken as a score for each immediate and delayed recall trial. Each word recalled was given credit only once for each trial and the repetitions of correct words did not receive additional credit in any trial. The score range for each trial was 0 to 12 points. The trial 1 recall total score was subtracted from the trial 4 recall total score to find learning slope. The score range for the learning

slope was -12 to +12 points. The percentage retention after delay was calculated as division of the delayed recall total score by the trial 4 recall total score and multiplying the quotient by 100. If the score was greater than 100, it was rounded down to 100. When the trial 4 recall total score was 0, the percentage retention score was set to 0. The score range for the percentage retention was 0 to 100% (Wechsler, 1998).

Intrusions – contaminations, confabulations and perseverations were carefully recorded verbatim for the study participants in each immediate trial and in delayed recall condition. The number of intrusions made by participants was counted for each of three types of intrusions. After the average of these three types of intrusions were taken as an individual error score for the Word Lists Learning' task. A contaminations in this task means inclusion of the words from the Verbal Paired Associates' task in the trials 1-4, or the delayed trial of the Word Lists Learning task.

10.2. Participants

Case-control study of dual-task performance was performed by forming groups of VaD patients, young and healthy old subjects. Young subjects were included in the study for determining age related changes in dual-task performance and to make it possible to differentiate normal aging from dementia.

64 young controls, 33 men and 31 women, aged 17-25 ($M=20.69$; $SD=2.97$) years were recruited for the experiment from different universities of Georgia. 64 normal elderly participants - 31 men and 33 women, aged 50-75 ($M=59.77$; $SD=7.13$) were included as matched controls for the VaD patients.

15 VaD patients - 8 men and 7 women (mean age $M=65.6$; $SD=8.64$) were selected according to revising the histories of disease in medical archives of different Georgian clinics. Only patients with appropriate neuroimaging studies were chosen for further analysis and contacted by the experimenter. Patients' history, risk factors, neurological signs were investigated. The NINDS-AIREN criteria and diagnostic tool ICD-10 were used to establish diagnosis of VaD. The study recruited mild and moderate VaD patients for which dementia severity level was determined by MMSE with mean of 19.6 ($SD = 4.64$, range = 11-25). The mean duration of illness was 3.3 years ($SD = 2.51$, range = .5-10). The group of VaD patients was not homogeneous in respect of presence of hereditary disposition to vascular disease, presence of diabetes mellitus and type of neuropathologic changes of brain. For different patients the lesions of the brain appeared in different combinations of brain regions – cortical and subcortical, with different localization (cortical damage, basal ganglia, white matter, cerebellum or brain stem damage) or solely in cortical

or subcortical regions. Some of the patients had concomitant atrophy. The number of lacunar damage was also different for different patients, having one or multiple lacunas on MRI. Table 1 presents the frequency of aforementioned neurological changes, which appeared in different combinations for each VaD patient.

Table 1. The frequency of presence of neurological changes for VaD patients.

Neurological changes	Percent of VaD patients
Concomitant atrophy	80
Diabetes Mellitus	33.3
Number of lacunas	One – 13.3 Multiple – 80
Hereditary factors	60
Brain cortex	46.7
Variable	Percent
Basal ganglia	6.7
White matter	80
Cerebellum	20
Brain stem	13.3

General neuropsychological assessment was carried out on the VaD patients and severe aphasia cases (19 patients) were excluded from the experiments. For the participants educational level was determined by the number of education years. Young participants had a mean of 14.31 years of education (SD = 2.42, range = 7-17) and elderly participants had a mean of 15.76 years of education (SD = 2.3, range = 8-17).

According to previous experience with this kind of experiment, the inclusion of no less than 30 participants in each study group ensures enough statistical power for data analyses.

10.3. Procedures

Damaged neuroanatomical structures of VaD patients were determined by the CT scanner T1-weighted-MRI (Magnetic Field – 0.2 Tesla). Computerised task was run on computer Pentium 2, with monitor screen 314mm × 216mm.

As was presented above the experimental material included dual-tasks' computerised and paper and pencil versions (List Memory Task – perceptuomotor tracking). Severity levels of cognitive impairments of VaD patients were determined by MMSE. VaD patients were administered the qualitative assessment procedure of aphasia for excluding the cases with aphasia. Working Memory Span task was used to determine working memory capacity of the study participants. Two WMS-III subtests - the Verbal Paired Associates task and Word Lists task were administered to determine participants' episodic memory performance.

The experimental methods and procedure was approved by the Ethic Commission of the Georgian State Medical Academy.

All participants underwent neurological assessment by a trained neurologist while neuropsychological examination was carried out by a qualified neuropsychologist. CT, MRI and neurosonological evaluation was taken from patients' histories of disease.

At the beginning of the experiment MMSE, WMS and the two WMS-III subtests - the Verbal Paired Associates task and the Word Lists task were administered to participants. The presentation of episodic memory tasks was constant across participants – the Verbal Paired Associates task was always administered first and the Word Lists task second. VaD patients were further examined with the qualitative assessment procedure of aphasia.

Subjects performed Digit Span Determination procedure, then List Memory (Single Task) Task, then computerised Tracking (Single Task) Task, after computerised dual task (digit span - motor tracking), then retest of computerised dual task, then paper and pencil tracking task (Single Task), after paper and pencil dual task (digit span – motor tracking), then retest of paper and pencil dual task. Both single tasks and dual task continued during the “2” minutes.

The presentation order of digit recall and tracking performed as single tasks was counterbalanced across participants. In the beginning of the computerised tracking task the experimenter showed the participant how to begin and perform the motor tracking task. After participants had a short training trial to ensure that they properly understood the task. The presentation order of the computerised and paper and pencil versions of the task was counterbalanced across participants.

Data was analysed by SPSS 10.0.

11. Experiment 1

An Age effect on Dual-Task

11.1. Aims

A number of studies have demonstrated that healthy adults – young and elderly, can perform under demanding dual-task conditions with very little performance degradation on either task relative to single task baseline levels (Baddeley et al., 1991; Baddeley et al., 1986; Della Sala et al., 1995). In some studies no dual-task decrement was detected, but in other studies a minor dual-task decrement was observed when a verbal memory task was combined with a tracking task (Duff & Logie, 2001). The observed dual-task decrements were limited to modest reduction in performance

levels despite very high task demands. The Experiment 1 addressed the issue of ageing effect in dual-task in a healthy Georgian population. Particularly the Experiment 1 aims at

a) Investigating if healthy elderly participants perform computerised and paper and pencil versions of the dual-task worse than healthy young subjects;

b) Showing whether healthy elderly participants' dual-task decrement is more overt in computerised versus paper pencil version of dual task;

c) Investigating whether the paper and pencil version of the dual-task is a comparable counterpart of the computerised version of the dual-task.

d) Investigating any possible effect of education.

e) Determining norms for dual task performance for the Georgian elderly population.

11.2. Methods

Participants

All the 64 young controls and all the 64 elderly participants entered Experiment 1 (see page 61).

Tasks

MMSE, Digit Span Determination procedure, List Memory (Single Task) Task, computerised Tracking (Single Task) Task, computerised dual task (digit span - motor tracking), retest of computerised dual task, paper and pencil tracking task (Single Task), paper and pencil dual task (digit span – motor tracking) and retest of paper and pencil dual task were administered to all the participants.

Procedure

Subjects performed Digit Span Determination procedure, then List Memory (Single Task) Task, then computerised Tracking (Single Task) Task, after computerised dual task (digit span - motor tracking), then retest of computerised dual task, then paper and pencil tracking task (Single Task), after paper and pencil dual task (digit span – motor tracking) and then retest of paper and pencil dual task. Both single tasks and dual task continued during 2 minutes.

The presentation order of digit recall and tracking performed as single tasks was counterbalanced across participants. In the beginning of the computerised tracking task the experimenter showed the participant how to begin and perform the motor tracking task. After participants had a short training trial to ensure that they properly understood the task. The

presentation order of the computerised and paper and pencil versions of the task was counterbalanced across participants.

11.3. Results

11.3.1. The computerised version of the dual-task.

Table 2 reports the means of the digit span, List Memory Task and computerized motor tracking for healthy young and elderly subjects.

Table 2. Mean performances on computerized version of the dual task for study groups

		Digit span	List Memory Task				Motor Tracking	
			Digits recalled correctly		Lists recalled correctly		% accuracy score	
Subjects			Single	Dual	Single	Dual	Single	Dual
young	Mean	5.22	.91749	.86816	.81532	.70744	53.429	53.75
	<i>SD</i>	(.98)	(.08)	(.09)	(.15)	(.19)	(7.09)	(8.20)
old	Mean	4.62	.92610	.88179	.83279	.73779	52.594	48.71
	<i>SD</i>	(.73)	(.06)	(.10)	(.14)	(.19)	(7.53)	(8.21)

To determine the effect of dual task on performance of List Memory Task (using digits recalled correctly and lists recalled correctly respectively) and motor tracking, the data from the single and dual tasks were entered separately into a 2 (group) × 2 (condition – type of task: single vs. dual) analysis of variance (ANOVA). For the List Memory Task - digits recalled correctly, the ANOVA showed a significant effect of type of task, $F(1,125)=27.842$, $MSE = .005$, $p < .0001$. There was no effect of group and no interaction ($F < 1$). For the List Memory Task - lists recalled correctly, the ANOVA showed a significant effect of type of task, $F(1,120)=36.388$, $MSE = .017$, $p < .0001$. There was no effect of group and no interaction ($F < 1$). For the computerised motor tracking task the ANOVA showed a significant effect of type of task, $F(1,125)=8.516$, $MSE=23.622$, $p < .004$; of group $F(1,125)=5.642$, $MSE=97.154$, $p < .019$ and an interaction $F(1,125)=11.886$, $MSE=23.622$, $p < .001$ (Figure 3).

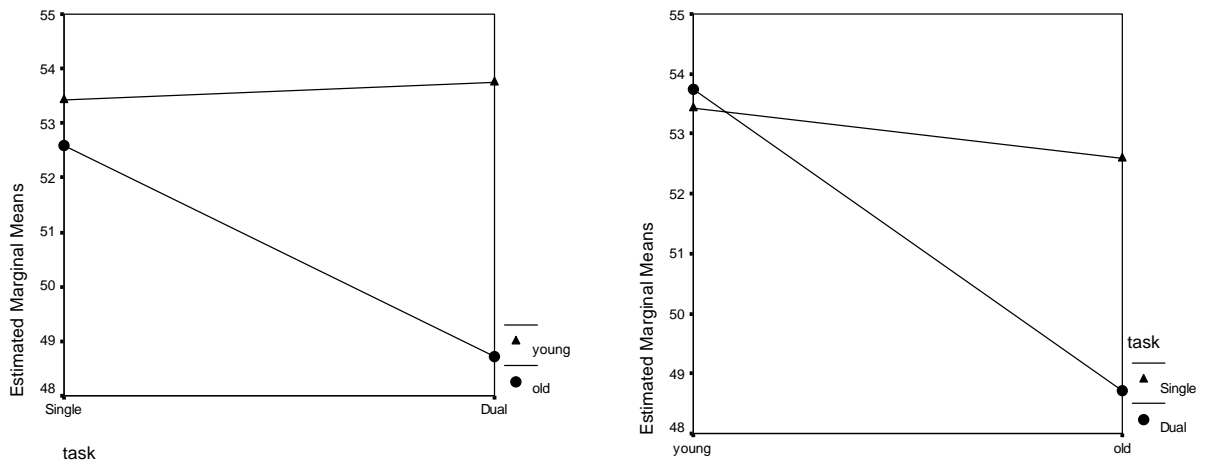

Figure 3. The motor tracking task performance by healthy young and elderly subjects.

In the previous dual-task study (Logie et al., 2004) it was shown that reporting of the patterns for each individual task under dual task condition might be misleading, because this cannot account for the overall changes in performance across both tasks or for trade-offs in performance between tasks. Thus, an overall measure of performance – percentage change, was calculated for each participant. The percentage change combines the percentage change in accuracy that occurs between the single and dual tasks for the List Memory Task and the motor tracking task (Baddeley & Della Sala, 1996).

The percentage change formula is the following:

$$\text{Percentage change} = \frac{\text{Single task performance} - \text{dual task performance}}{\text{Single task performance}} \times 100$$

The percentage change for each task was combined as follows:

$$\text{Combined percentage change (mu)} = 100 - \frac{\text{Percentage change verbal} + \text{Percentage change tracking}}{2}$$

When this formula was applied to the validating study, a clear separation between performance of AD patients and control subjects was found (Baddeley & Della Sala, 1996).

Three percentage change scores were calculated: for the List Memory Task digits recalled correctly, for the List Memory Task lists recalled correctly and for the perceptuomotor tracking task. Table 3 presents these three percentage change scores.

Table 3. The percentage change scores for the computerised version of the dual-task.

		Percentage change for the digits recalled correctly	Percentage change for the lists recalled correctly	Percentage change for the motor tracking
young	Mean	4.9820	11.7679	-9.019
	Number of participants	63	60	63
	Std. Deviation	11.006	26.250	11.315
	Minimum	-25.36	-84.62	-34.09
	Maximum	26.10	67.69	20.02
old	Mean	4.5282	10.1377	6.7983
	Number of participants	64	62	64
	Std. Deviation	10.942	23.274	13.142
	Minimum	-23.72	-92.00	-19.82
	Maximum	44.48	77.04	43.16

There was no statistically significant difference found the two study groups for percentage change scores using the List Memory Task digits recalled correctly and lists recalled correctly. Only the significant difference was found between means of young and elderly participants for the computerised motor tracking percentage change score $t(125) = -3.536$; $p < .001$.

The combined percentage change *mu* score takes into account the overall impact of dual-task demands and the overall change across both tasks between single and dual task performance. Using this formula two combined percentage change scores were calculated for each participant. One was calculated for digits recalled correctly and another for the list recalled correctly. Means of these scores are presented in the Table 4 and Figure 4.

Table 4. The combined percentage change *mu* scores for computerised version of the dual-task.

		Digits recalled correctly	Lists recalled correctly
young	Mean	97.9599	94.6703
	Number of participants	63	60
	Std. Deviation	8.156	14.895
	Minimum	79.93	68.74
	Maximum	124.39	154.01
old	Mean	94.3368	91.7759
	Number of participants	64	62
	Std. Deviation	8.684	13.724
	Minimum	72.60	54.95
	Maximum	108.74	141.55

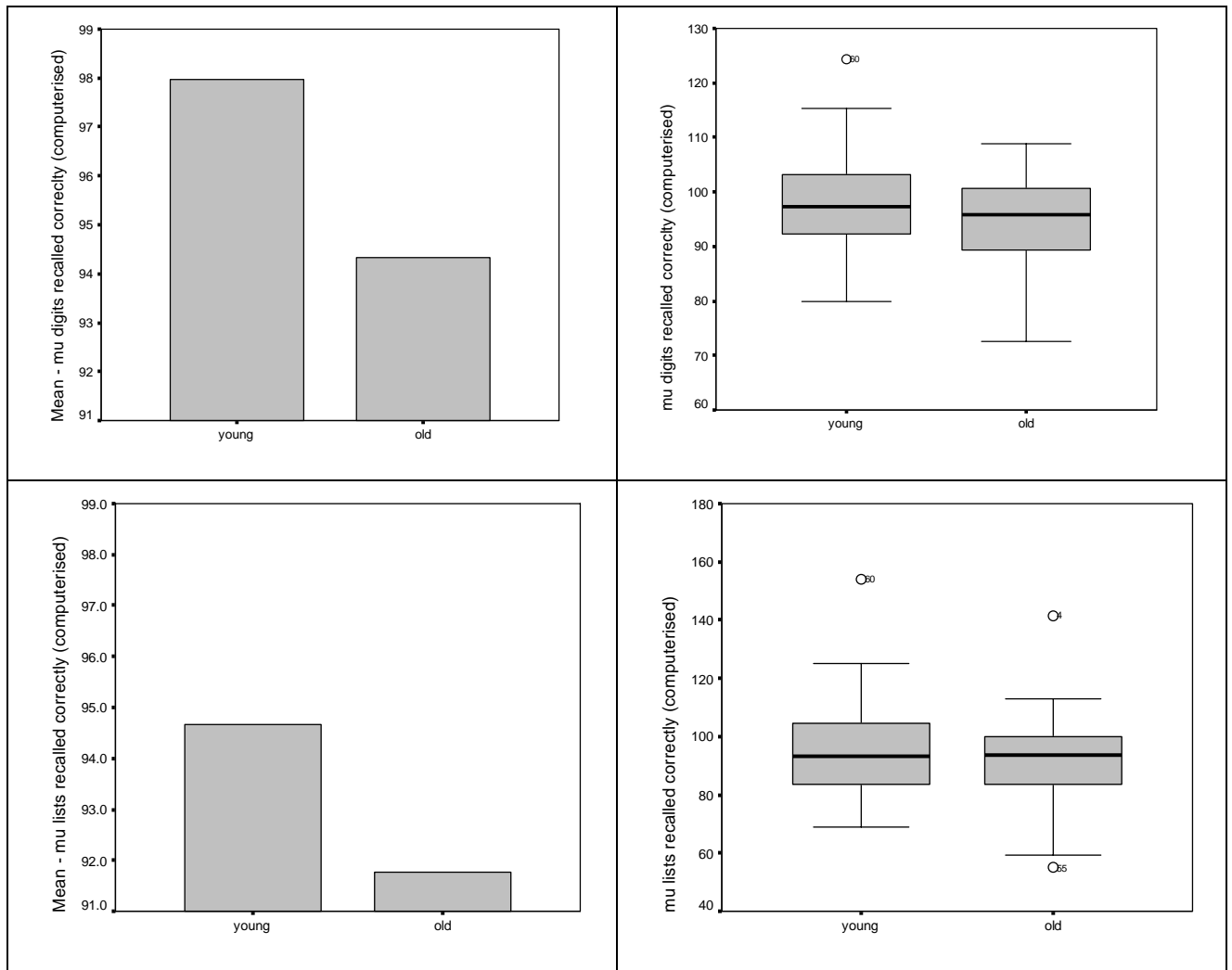
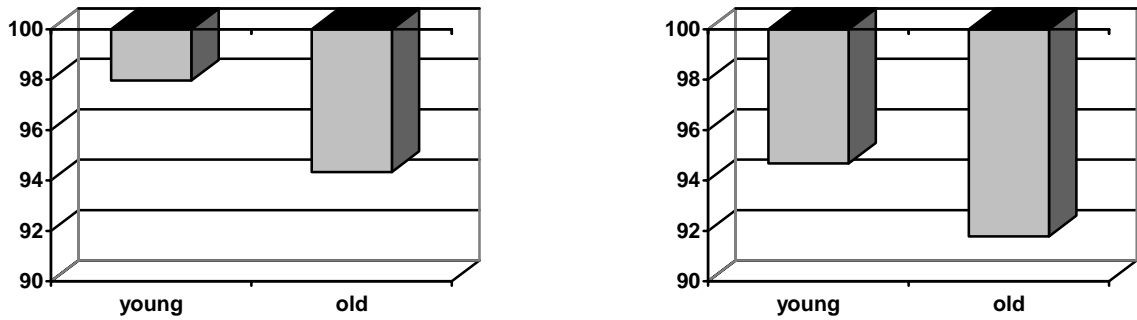

Figure 4. The means of *mu* scores for young and elderly participants.

The comparison in between groups showed decrement in the combined percentage change *mu* scores under dual task condition. The combined percentage change scores using digits recalled correctly data for young subjects showed a decrement of 2.04% and for old subjects 5.66%. The combined percentage change scores using lists recalled correctly data for the young subjects showed the decrement of 5.33% and for the old subjects of 8.22% (Figure 5). A statistically significant difference was found only for the combined percentage change score for the digits recalled correctly $t(125) = 2.423$; $p < .017$, young performed slightly better under dual task conditions than old subjects.



a. Digits recalled correctly

b. Lists recalled correctly

Figure 5. The combined percentage change *mu* scores for computerised version of the dual-task.

The old subjects' education level was significantly higher than young participants' level of education $t(115.529) = -3.025$; $p < .003$. To show whether education has an impact on the study results, education effect was partialled out from the different statistical analysis used in the Experiment 1.

To determine the effect of dual task on performance of List Memory Task (using digits recalled correctly and lists recalled correctly) and motor tracking, the data from the single and dual tasks were entered separately into a 2 (group) \times 2 (condition – type of task: single vs. dual) analysis of variance and education was taken as a covariate. No significant effect of education and no covariate \times condition interaction were found for tasks, indicating no education effect of the study groups' performance under dual task condition.

The education effect on percentage change scores was excluded by using the Univariate (the one-way factorial) ANOVA. The main effect of education was not significant for the three percentage change scores. The age differences remain significant on percentage change score for the computerised motor tracking when controlling the effect of the level of education $F(1,124) = 10.966$, $MSE = 151.577$, $p < .001$.

The education effect on combined percentage change *mu* scores were controlled by using the Univariate (the one-way factorial) ANOVA. The main effect of education was not significant for the two combined percentage change scores. The age difference remained significant for the combined percentage change score for the List Memory Task - digits recalled correctly while controlling education level effect $F(1,124) = 4.762$, $MSE = 71.361$, $p < .031$, again young participants performed better under dual task condition than elderly.

11.3.2. The paper and pencil version of the dual-task.

Table 5 reports the means of the digit span, List Memory Task and paper and pencil motor tracking for healthy young and elderly subjects.

Table 5. Mean performances on paper and pencil version of the dual task for study groups

		Digit span	List Memory Task				Motor Tracking	
			Digits recalled correctly		Lists recalled correctly		Number of crossed arrows	
Subjects			Single	Dual	Single	Dual	Single	Dual
young	Mean	5.22	.91749	.92751	.81532	.81755	186.02	181.02
	SD	(.98)	(.08)	(.06)	(.15)	(.14)	(27.55)	(31.43)
old	Mean	4.62	.92610	.93484	.83279	.85109	157.97	152.71
	SD	(.73)	(.06)	(.07)	(.14)	(.15)	(31.09)	(31.89)

To determine the effect of dual task on performance of List Memory Task (using digits recalled correctly and lists recalled correctly) and motor tracking, the data from the single and dual tasks were entered separately into a 2 (group) × 2 (condition – type of task: single vs. dual) analysis of variance (ANOVA). For the List Memory Task - digits recalled correctly and List Memory Task - lists recalled correctly, the ANOVA showed no significant effect of type of task, no effects of group and no interaction ($F < 1$). For the paper and pencil motor tracking task, an ANOVA showed a significant effect of type of task, $F(1,120)=6.619$, $MSE=242.383$, $p < .011$ and of group $F(1,120)=29.804$, $MSE=1624.623$, $p < .0001$ but no interaction ($F < 1$).

Three percentage change scores were calculated: for the List Memory Task digits recalled correctly, for the List Memory Task lists recalled correctly and for the perceptuomotor tracking task. Table 6 presents these three percentage change scores.

Table 6. The percentage change scores for the paper and pencil version of the dual-task.

		Percentage change for the digits recalled correctly	Percentage change for the lists recalled correctly	Percentage change for the motor tracking
young	Mean	-.9541	-2.9276	2.5493
	Number of participants	60	60	60
	Std. Deviation	9.354	24.086	9.843
	Minimum	-36.54	-87.50	-23.85
	Maximum	17.29	40.00	38.46
old	Mean	-.7661	-4.5081	2.2233
	Number of participants	62	62	62
	Std. Deviation	8.691	25.849	16.219
	Minimum	-39.54	-140.00	-41.72
	Maximum	25.35	63.64	44.67

There were no statistically significant differences between means of the two study groups for percentage change scores.

The two combined percentage change *mu* scores were calculated for the paper and pencil version of the dual-task. One was calculated for digits recalled correctly and another for the list recalled correctly. Means of these scores are presented in the Table 7 and Figure 6.

Table 7. The combined percentage change *mu* scores for paper and pencil version of the dual-task.

		Digits recalled correctly	Lists recalled correctly
young	Mean	99.2024	100.1892
	Number of participants	60	60
	Std. Deviation	7.060	13.713
	Minimum	72.91	60.77
	Maximum	115.43	141.61
old	Mean	99.2714	101.1424
	Number of participants	62	62
	Std. Deviation	10.404	17.383
	Minimum	67.40	48.26
	Maximum	130.18	180.42

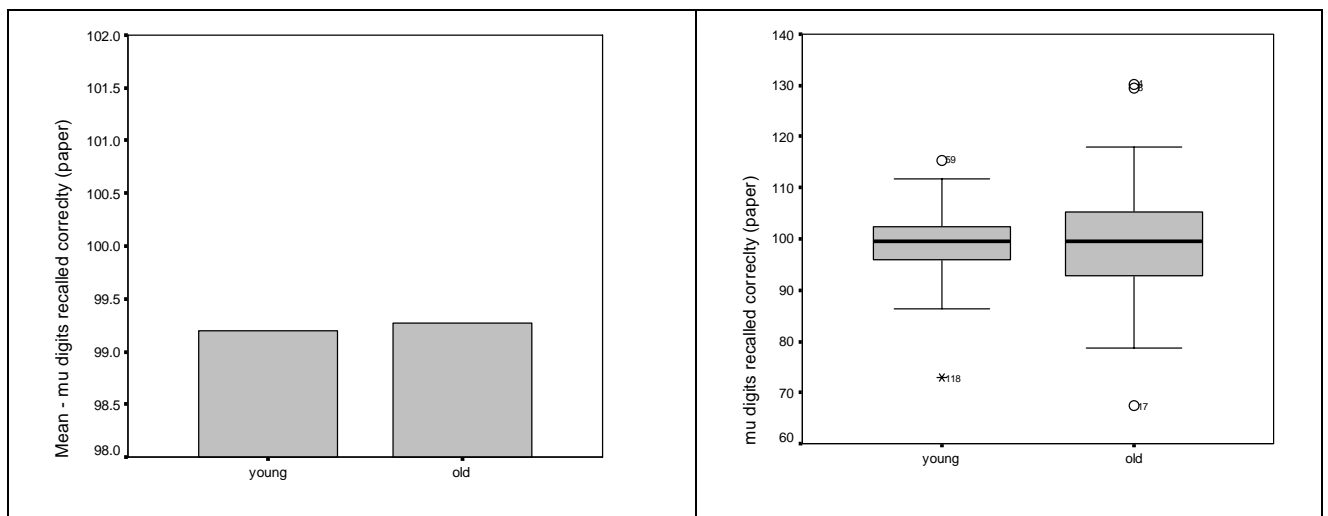

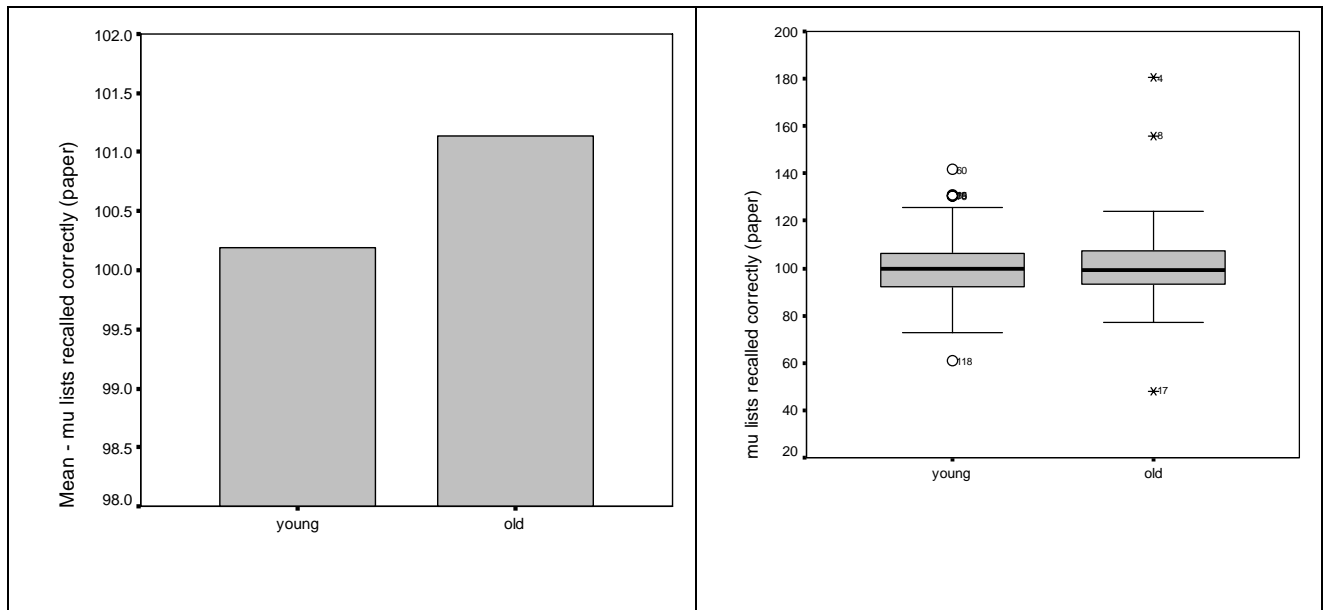
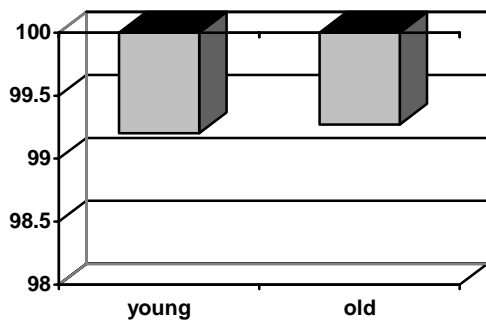
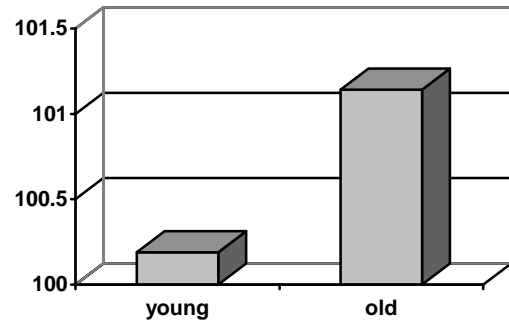

Figure 6. The means of *mu* scores for young and elderly participants.

For the combined percentage change *mu* scores using digits recalled correctly data young subjects showed a slight decrement of .79% and old subjects of .73%. For the combined percentage change scores using lists recalled correctly data young subjects showed a small increment of .19% and old subjects of 1.14% (Figure 7). No statistically significant difference was found for either of the combined percentage change score between young and old participants.



a. Digits recalled correctly



b. Lists recalled correctly

Figure 7. The combined percentage change *mu* scores for paper and pencil version of the dual-task.

To show whether education has an impact on the study results, education effect was excluded from the different statistical analysis used for the paper and pencil version of the dual-task data.

To determine the effect of dual task on performance of List Memory Task (using digits recalled correctly and lists recalled correctly) and motor tracking, the data from the single and dual tasks were entered separately into a 2 (group) \times 2 (condition – type of task: single vs. dual) analysis of variance and education was taken as a covariate. No significant effect of education and no covariate \times condition interaction were found for the List Memory Task - digits recalled correctly and the List Memory Task - lists recalled correctly. A significant effect of education was found for

the paper and pencil motor task $F(1,119)=6.27$, $MSE =1556.277$, $p<.014$ indicating the effect of education on motor tracking under dual task condition. The significant effect of the group was remained $F(1,119)=36.023$, $MSE =1556.277$, $p<.0001$ while the effect of type of task ($F<1$) was no longer significant.

The education effect on percentage change scores and combined percentage change *mu* scores was excluded by using the Univariate (the one-way factorial) ANOVA. The main effect of education was not significant for the three percentage change scores nor for the two combined percentage change scores.

11.3.3. The correlation of the test-retest and of the computerised - paper and pencil versions of the dual-task.

To assess the test-retest reliability of the combined percentage change scores *mu*, correlations between the computerised and the paper and pencil dual-task *mu* scores were found separately for the young and for the elderly participants (Table 8 and Table 9 respectively). The partial correlation analysis was performed on the same variables to exclude the effect of education. In tables 7-8 the sign ** indicates that the correlation is significant at the 0.01 level (2-tailed). The sign * indicates that the correlation is significant at the 0.05 level (2-tailed).

The young subjects showed high significant test-retest reliability for the computerised ($r=.71$, $p<.0001$; $r=.65$, $p<.0001$) and the paper and pencil ($r=.76$, $p<.0001$; $r=.81$, $p<.0001$) dual-task *mu* scores. The exclusion of the influence of education level barely changed magnitude or significance levels of the reliability coefficients (Table 8).

Table 8. Correlation of the test-retest dual task *mu* scores for the young participants.

The <i>mu</i> scores					
		Computerised (digits recalled correctly)	Computerised (lists recalled correctly)	Paper and pencil (digits recalled correctly)	Paper and pencil (lists recalled correctly)
Retest - computerised (digits recalled correctly)	Pearson Correlation	.710(**)	.553(**)	.057	.144
	Sig. (2-tailed)	.0001	.0001	.666	.273
	Number of participants	63	60	60	60
Retest - computerised (lists recalled correctly)	Pearson Correlation	.660(**)	.654(**)	.157	.312(*)
	Sig. (2-tailed)	.0001	.0001	.232	.015
	Number of participants	60	60	60	60
Retest - paper and pencil (digits recalled correctly)	Pearson Correlation	.274(*)	.371(**)	.755(**)	.738(**)
	Sig. (2-tailed)	.034	.004	.0001	.0001
	Number of participants	60	60	60	60

Retest - paper and pencil (lists recalled correctly)	Pearson Correlation	.296(*)	.482(**)	.701(**)	.805(**)
	Sig. (2-tailed)	.022	.0001	.0001	.0001
	Number of participants	60	60	60	60
The <i>mu</i> scores - education is partialled out					
		Computerised (digits recalled correctly)	Computerised (lists recalled correctly)	Paper and pencil (digits recalled correctly)	Paper and pencil (lists recalled correctly)
Retest - computerised (digits recalled correctly)	Pearson Correlation	.7045(**)	.5451(**)	.0453	.1337
	Sig. (2-tailed)	.0001	.0001	.733	.313
	Number of participants	57	57	57	57
Retest - computerised (lists recalled correctly)	Pearson Correlation	.6542(**)	.6490(**)	.1460	.3036(*)
	Sig. (2-tailed)	.0001	.0001	.270	.019
	Number of participants	57	57	57	57
Retest - paper and pencil (digits recalled correctly)	Pearson Correlation	.2780(**)	.3779(**)	.7592(**)	.7411(**)
	Sig. (2-tailed)	.033	.003	.0001	.0001
	Number of participants	57	57	57	57
Retest - paper and pencil (lists recalled correctly)	Pearson Correlation	.2889(*)	.4793(**)	.6990(**)	.8044(**)
	Sig. (2-tailed)	.026	.0001	.0001	.0001
	Number of participants	57	57	57	57

The elderly participants showed slightly higher test-retest reliability in performance of the computerised ($r=.75$, $p<.0001$; $r=.75$, $p<.0001$) and paper and pencil ($r=.90$, $p<.0001$; $r=.92$, $p<.0001$) versions of dual-task. The exclusion of the influence of education level barely changed magnitude or significance levels of the reliability coefficients (Table 9).

Table 9. Correlation of the test-retest dual task *mu* scores for the old participants.

The <i>mu</i> scores					
		Computerised (digits recalled correctly)	Computerised (lists recalled correctly)	Paper and pencil (digits recalled correctly)	Paper and pencil (lists recalled correctly)
Retest - computerised (digits recalled correctly)	Pearson Correlation	.752(**)	.649(**)	.211	.245
	Sig. (2-tailed)	.0001	.0001	.100	.055
	Number of participants	64	62	62	62
Retest - computerised (lists recalled correctly)	Pearson Correlation	.712(**)	.747(**)	.213	.344(**)
	Sig. (2-tailed)	.0001	.0001	.097	.006
	Number of participants	62	62	62	62
Retest - paper and pencil (digits recalled correctly)	Pearson Correlation	.313(*)	.377(**)	.902(**)	.827(**)
	Sig. (2-tailed)	.013	.003	.0001	.0001
	Number of participants	62	62	62	62

Retest - paper and pencil (lists recalled correctly)	Pearson Correlation	.352(**)	.537(**)	.834(**)	.916(**)
	Sig. (2-tailed)	.005	.0001	.0001	.0001
	Number of participants	62	62	62	62
The <i>mu</i> scores - education is partialled out					
		Computerised (digits recalled correctly)	Computerised (lists recalled correctly)	Paper and pencil (digits recalled correctly)	Paper and pencil (lists recalled correctly)
Retest - computerised (digits recalled correctly)	Pearson Correlation	.7478(**)	.6486(**)	.2081	.2417
	Sig. (2-tailed)	.0001	.0001	.108	.061
	Number of participants	59	59	59	59
Retest - computerised (lists recalled correctly)	Pearson Correlation	.7106(**)	.7461(**)	.2093	.3407(**)
	Sig. (2-tailed)	.0001	.0001	.105	.007
	Number of participants	59	59	59	59
Retest - paper and pencil (digits recalled correctly)	Pearson Correlation	.3124(*)	.3781(**)	.9027(**)	.8276(**)
	Sig. (2-tailed)	.014	.003	.0001	.0001
	Number of participants	59	59	59	59
Retest - paper and pencil (lists recalled correctly)	Pearson Correlation	.3516(**)	.5387(**)	.8344(**)	.9174(**)
	Sig. (2-tailed)	.005	.0001	.0001	.0001
	Number of participants	59	59	59	59

The correlation analysis was performed on the *mu* scores of the computerised and paper and pencil versions of the dual-task separately for young and old participants to find out whether these two versions of the dual task are comparable counterparts of each other. For the young participants a high significant correlation was found for the two computerised *mu* scores ($r=.88$, $p<.0001$). A slightly higher significant correlation was found for the two paper and pencil *mu* scores ($r=.91$, $p<.0001$) (Table 10). The exclusion of the influence of the education level barely changed magnitude or significance levels of the correlation coefficients. A relatively small significant correlation was found between the *mu* scores for the computerised and paper and pencil versions of the dual task that include the List Memory Task – digits recalled correctly ($r=.30$, $p<.02$). A higher significant correlation was found between the *mu* scores for the computerised and paper and pencil versions of the dual task that include the List Memory Task – lists recalled correctly ($r=.52$, $p<.0001$). The exclusion of the influence of education level again did not change magnitude or significance levels of the correlation coefficients.

Table 10. Correlation of the computerised and paper and pencil dual task *mu* scores for the young participants.

The <i>mu</i> scores					
		Computerised (digits recalled correctly)	Computerised (lists recalled correctly)	Paper and pencil (digits recalled correctly)	Paper and pencil (lists recalled correctly)
Computerised (digits recalled correctly)	Pearson Correlation	1	.882(**)	.299(*)	.410(**)
	Sig. (2-tailed)	.	.0001	.020	.001
	Number of participants	63	60	60	60
Computerised (lists recalled correctly)	Pearson Correlation	.882(**)	1	.367(**)	.519(**)
	Sig. (2-tailed)	.0001	.	.004	.0001
	Number of participants	60	60	60	60
Paper and pencil (digits recalled correctly)	Pearson Correlation	.299(*)	.367(**)	1	.914(**)
	Sig. (2-tailed)	.020	.004	.	.0001
	Number of participants	60	60	60	60
Paper and pencil (lists recalled correctly)	Pearson Correlation	.410(**)	.519(**)	.914(**)	1
	Sig. (2-tailed)	.001	.0001	.0001	.
	Number of participants	60	60	60	60
The <i>mu</i> scores - education is partialled out					
		Computerised (digits recalled correctly)	Computerised (lists recalled correctly)	Paper and pencil (digits recalled correctly)	Paper and pencil (lists recalled correctly)
Computerised (digits recalled correctly)	Pearson Correlation	1	.8778(**)	.2855(*)	.4000(**)
	Sig. (2-tailed)	.	.0001	.028	.002
	Number of participants	0	57	57	57
Computerised (lists recalled correctly)	Pearson Correlation	.8778(**)	1	.3538(**)	.5108(**)
	Sig. (2-tailed)	.0001	.	.006	.0001
	Number of participants	57	0	57	57
Paper and pencil (digits recalled correctly)	Pearson Correlation	.285(*)	.3538(**)	1	.9129(**)
	Sig. (2-tailed)	.028	.006	.	.0001
	Number of participants	57	57	0	57
Paper and pencil (lists recalled correctly)	Pearson Correlation	.4000(**)	.5108(**)	.9129(**)	1
	Sig. (2-tailed)	.002	.0001	.0001	.
	Number of participants	57	57	57	0

For the old participants the high significant correlations was found for the two computerised *mu* scores ($r=.89$, $p<.0001$). A slightly higher significant correlation was found for the two paper and pencil *mu* scores ($r=.92$, $p<.0001$) (Table 11). The exclusion of the influence of education level did not have a big effect on magnitude or significance levels of the correlation coefficients. A

relatively small significant correlation was found between the *mu* scores for the computerised and paper and pencil versions of the dual task that include the List Memory Task – digits recalled correctly ($r=.28$, $p<.029$). A higher significant correlation was found between the *mu* scores for the computerised and paper and pencil versions of the dual task that include the List Memory Task – lists recalled correctly ($r=.49$, $p<.0001$). The exclusion of the influence of the education level again did not change magnitude or significance levels of the correlation coefficients.

Table 11. Correlation of the computerised and paper and pencil dual task *mu* scores for the old participants.

The <i>mu</i> scores					
		Computerised (digits recalled correctly)	Computerised (lists recalled correctly)	Paper and pencil (digits recalled correctly)	Paper and pencil (lists recalled correctly)
Computerised (digits recalled correctly)	Pearson Correlation	1	.889(**)	.277(*)	.335(**)
	Sig. (2-tailed)	.	.0001	.029	.008
	Number of participants	64	62	62	62
Computerised (lists recalled correctly)	Pearson Correlation	.889(**)	1	.341(**)	.492(**)
	Sig. (2-tailed)	.0001	.	.007	.0001
	Number of participants	62	62	62	62
Paper and pencil (digits recalled correctly)	Pearson Correlation	.277(*)	.341(**)	1	.915(**)
	Sig. (2-tailed)	.029	.007	.	.0001
	Number of participants	62	62	62	62
Paper and pencil (lists recalled correctly)	Pearson Correlation	.335(**)	.492(**)	.915(**)	1
	Sig. (2-tailed)	.008	.0001	.0001	.
	Number of participants	62	62	62	62
The <i>mu</i> scores - education is partialled out					
		Computerised (digits recalled correctly)	Computerised (lists recalled correctly)	Paper and pencil (digits recalled correctly)	Paper and pencil (lists recalled correctly)
Computerised (digits recalled correctly)	Pearson Correlation	1	.8876(**)	.2729(*)	.3303(**)
	Sig. (2-tailed)	.	.0001	.033	.009
	Number of participants	0	59	59	59
Computerised (lists recalled correctly)	Pearson Correlation	.8876(**)	1	.3359(**)	.4877(**)
	Sig. (2-tailed)	.0001	.	.008	.0001
	Number of participants	59	0	59	59
Paper and pencil (digits recalled correctly)	Pearson Correlation	.2729(*)	.3359(**)	1	.9142(**)
	Sig. (2-tailed)	.033	.008	.	.0001
	Number of participants	59	59	0	59

Paper and pencil (lists recalled correctly)	Pearson Correlation	.3303(**)	.4877(**)	.9142(**)	1
	Sig. (2-tailed)	.009	.0001	.0001	.
	Number of participants	59	59	59	0

11.3.4. The norms for the mu scores.

According to the study aims norms for the *mu* scores were prepared for the computerised and the paper and pencil versions of the dual task for the Georgian elderly population (Table 12 and Figure 8). The means and standard deviations were calculated for the *mu* scores. The cut-of scores for the normal population were determined as $M \pm 2SD$ for each *mu* score.

Table 12. The means, standard deviations and $M \pm 2SD$ for the *mu* scores for the elderly participants.

	The <i>mu</i> scores			
	Computerised (digits recalled correctly)	Computerised (lists recalled correctly)	Paper and pencil (digits recalled correctly)	Paper and pencil (lists recalled correctly)
Mean	94.3368	91.7759	99.2714	101.1424
SD	8.68437	13.72393	10.40359	17.38293
Mean – 2×SD	76.96806	64.32804	78.46422	83.75947
Mean + 2×SD	111.70554	119.22376	120.07858	135.90826

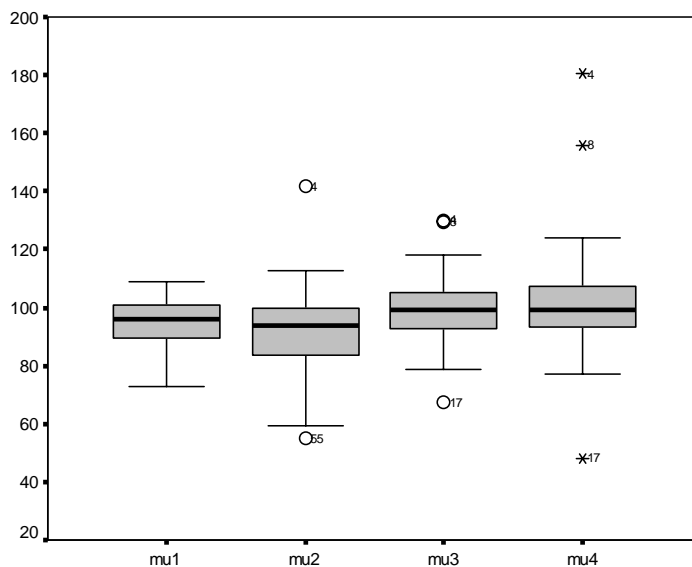

Figure 8. The *mu* scores for the elderly participants (mu1 – for the computerised dual-task using digits recalled correctly; mu2 - for the computerised dual-task using lists recalled correctly; mu3 - for the paper and pencil dual-task using digits recalled correctly; mu4 - for the paper and pencil dual-task using lists recalled correctly).

A separate table with norms was prepared using different levels of education for the elderly participants. In Table 13 the *mu* scores and appropriate cut-off scores were calculated for three different education levels common to the Georgian elderly population, persons who finished university, persons who finished professional technical school and those who finished high school.

Table 13. The means, standard deviations and $M \pm 2SD$ for the *mu* scores for the elderly participants with 3 different levels of education.

		The <i>mu</i> scores			
		Computerised (digits recalled correctly)	Computerised (lists recalled correctly)	Paper and pencil (digits recalled correctly)	Paper and pencil (lists recalled correctly)
Number of participants	University	55	53	53	53
	Proftech	7	7	7	7
	School	2	2	2	2
Mean	University	94.3622	92.0878	99.7583	101.8389
	Proftech	96.7001	93.5213	98.1591	99.5941
	School	85.366	77.4015	90.2618	88.1026
Std. Deviation	University	8.39014	13.61380	10.76902	18.40434
	Proftech	8.40678	8.20203	4.99906	6.55570
	School	18.05360	31.75377	15.43633	13.35304
Mean – 2×SD	University	77.58192	64.8602	78.22026	65.03022
	Proftech	79.88654	77.11724	88.16098	86.4827
	School	49.2588	13.89396	59.38914	61.39652
Mean + 2×SD	University	111.14248	119.3154	121.29634	138.64758
	Proftech	113.51366	109.92536	108.15722	112.7055
	School	121.4732	140.90904	121.13446	114.80868

In Table 14 the *mu* scores and appropriate cut-off scores were calculated for two levels of education: the persons who finished university are denoted as ‘high level of education’ and those who finished professional technical school and high school are together denoted as ‘low level of education’.

Table 14. The means, standard deviations and $M \pm 2SD$ for the *mu* scores for the elderly participants with 2 different levels of education.

		The <i>mu</i> scores			
		Computerised (digits recalled correctly)	Computerised (lists recalled correctly)	Paper and pencil (digits recalled correctly)	Paper and pencil (lists recalled correctly)
Number of participants	High education	55	53	53	53
	Low education	9	9	9	9
Mean	High education	94.3622	92.0878	99.7583	101.8389
	Low education	94.1814	89.9392	96.4041	97.0404
Std. Deviation	High education	8.39014	13.61380	10.76902	18.40434
	Low education	10.89612	15.06714	7.78811	8.95534
Mean – 2×SD	High education	77.58192	64.8602	78.22026	65.03022
	Low education	72.38916	59.80492	80.82788	79.12972

Mean + 2×SD	High education	111.14248	119.3154	121.29634	138.64758
	Low education	115.97364	120.07348	111.98032	114.95108

A table with norms was prepared for different age intervals. The two age intervals were determined starting from 50-60 years and 61 and higher. In Table 15 the *mu* scores and appropriate cut-off scores are calculated for these two intervals.

Table 15. The means, standard deviations and M±2SD for the *mu* scores for the elderly participants with 2 different age intervals.

		The <i>mu</i> scores			
		Computerised (digits recalled correctly)	Computerised (lists recalled correctly)	Paper and pencil (digits recalled correctly)	Paper and pencil (lists recalled correctly)
Number of participants	50-60	35	35	35	35
	61-high	29	27	27	27
Mean	50-60	93.5727	90.4558	99.3105	99.3858
	61-high	95.2589	93.4871	99.2207	103.4195
Std. Deviation	50-60	9.10071	12.01749	7.75365	10.11927
	61-high	8.21646	15.73675	13.24060	23.77989
Mean – 2×SD	50-60	75.37128	66.42082	83.8032	79.14726
	61-high	78.82598	62.0136	72.7395	55.85972
Mean + 2×SD	50-60	111.77412	114.49078	114.8178	119.62434
	61-high	111.69182	124.9606	125.7019	150.97928

11.4. Discussion

Experiment 1 showed significant effect of the type of task for all three computerised verbal and motor tasks and significant group effect and group by condition interaction for the computerised motor tracking task. In the paper and pencil version of the dual-task only for the motor tracking task a significant effect of type of task and of group was found.

To take into account the overall changes in performance of two study groups across both tasks and to consider the trade-offs in performance between tasks, percentage change and combined percentage change *mu* scores were introduced. No significant age effect was detected on percentage change scores for computerised and paper and pencil versions of the dual task. Only the percentage change score for the computerised motor tracking task was significant. No significant age difference was shown in overall performance of paper and pencil dual task. A significant age effect was detected for the computerised *mu* score, which was calculated using List Memory Task – digits recalled correctly. The mean performance of young subjects was higher than of elderly participants.

Since significant differences in the level of education was detected between the two study groups, which could influence observed age differences in dual-task performance, education effect was excluded from the analysis of the dual-task data.

In the computerised tasks (2 verbal and 1 motor tracking) the effect of type of task was no longer significant when the level of education was controlled, but the effect of group and group by condition interaction remained significant for the motor tracing task. Performance of the motor tracing task in the paper and pencil version of the dual-task a significant main effect of education level was detected. The effect of type of task disappeared when the level of education was controlled. The main effect of group on motor tracking task remained significant.

To avoid misleading conclusions about the effect of the level of education on overall dual task performance, the percentage change and *mu* scores were analysed while controlling the effect of education.

Only significant age effect was found for the computerised percentage change score. The young participants performed better than elderly subjects. Again no statistically significant changes were detected on the percentage change and *mu* scores for the paper and pencil version of the dual-task while controlling the effect of education.

Again the significant age effect was detected for the computerised *mu* score using the List Memory task – digits recalled correctly while controlling the effect of education. The performance of young participants was superior to elderly participants under a dual-task condition when the effect of education was not excluded and remained the same after controlling the effect of education.

The two study groups showed minimal percentage increments or decrements of the *mu* scores for the computerised and paper and pencil versions of the dual-task, reaching significance just for the computerised *mu* score using the List Memory task – digits recalled correctly. The significant differences in observed decrements of two groups remained significant when controlling for level of education. The young group had significantly more of an increment than elderly subjects' group.

In conclusion, Experiment 1 showed no effect of age or level of education on the performance of the paper and pencil version of the dual-task. The small but significant age and education effects were detected for computerised version of the dual-task. These effects were detected just for one proposed measure (digits recalled correctly) of the dual-task performance, but not using the other measure (lists recalled correctly), which was used in previous studies (Baddeley et al., 1986; Della Sala et al., 1995) in which no significant effect of age was found. Thus this study replicated the results of previous studies where effect of age minimal or was not detected in performance of different versions of the dual-task.

The computerised and paper and pencil versions of the dual-task showed significant high reliability coefficients for both study groups, while comparing test-retest performance of the study participants. Level of education had no influence on the coefficients of reliability.

The correlation analysis showed moderate significant correlation between *mu* scores (lists recalled correctly) of the computerised and paper and pencil versions of dual-task, which wasn't changed when influence of the level of education was excluded. This finding together with practically the same results for the age and education factors shown by these two versions of dual-task indicates that paper and pencil version of the dual-task is a comparable counterpart of the computerised version of the dual-task.

The norms for the *mu* scores were defined for the Georgian elderly population. The norms and $M \pm 2SD$ cut-off scores will be the helpful normative information for using computerised and new "Tbilisi paper and pencil" dual-task methods for the Georgian elderly population to detect early cognitive changes characterised dementia patients in the neurology clinics of Georgia.

12. Experiment 2

The effect of Vascular Dementia on Dual-Task

12.1. Aims

In studies conducted on AD patients using a dual-task paradigm it was shown that a very robust specific dual-task decrement emerges for this group of dementia patients (Baddeley et al., 1986; Baddeley et al., 1999; Della Sala et al., 1995; Della Sala et al., 1992). The dual-task decrement for AD patients is significantly different from the healthy elderly performance under dual-task condition. Experiment 2 investigated whether the same specific pattern of dual-task decrement can be detected for VaD patients. The Experiment 2 aims at

a) Investigating whether VaD patients exhibit significant dual-task decrement in comparison to 1) age and education matched healthy elderly and education matched young participants, and 2) only age and education matched healthy elderly subjects;

b) Investigating whether a paper and pencil version of the dual-task can reveal the same pattern of dual-task decrement in VaD patients as is determined by the computerised version of the dual-task.

c) Determining the individual performances of the VaD patients in comparison to the norms for combined dual-task *mu* scores for the Georgian population.

12.2. Methods

Participants

To minimise the effects of age and education on dual-task performance, a group of elderly participants matched on age and education to VaD patients was selected. For each VaD patient a

healthy elderly participant from the 64 recruited elderly subjects was selected matched to them on age and education.

Two VaD patients were excluded from the analysis. One had a very low level of education (2 years) and was practically illiterate. Thus, this patient was very different from the sample of other patients and healthy controls. The second patient was excluded from the analysis because his/her was very young (47 years) relative to the rest of the group of VaD patients. No matched controls were found for these two patients. 13 VaD patients were included in the final analysis in Experiment 2.

The twice as many healthy elderly participants were selected as the age and education matched group of elderly participants. 26 elderly subjects and 13 VaD patients are included in the analysis. The mean age of VaD patients was 66.54 ($SD=7.344$) and the mean age of elderly participants was 65.42 ($SD=4.851$) ($t(17.409)=-.496$, $p=.626$ ns.). The mean level of education of VaD patients was 14.385 ($SD=2.219$) and the mean level of education of elderly participants was 15.404 ($SD=1.549$) ($t(18.049)=1.485$, $p=.155$ ns.). There was no difference on age and education level on dual task performance for the study groups.

26 young participants matched on education to 26 selected elderly subjects were selected. The mean age of young participants was 21.73 ($SD=2.426$). The mean level of education of young participants was 15.46 ($SD=2.387$) (for comparison of the means of the level of education of young and elderly participants $t(50)=.069$, $p=.945$ ns.).

Tasks

In Experiment 2 the same tasks were used as in Experiment 1

Procedure

In Experiment 2 the same experimental procedures were used as in Experiment 1.

12.3. Results

12.3.1. The dual-task performance by VaD patients, age and education matched healthy elderly and education matched young participants.

12.3.1.1. The computerised version of the dual-task.

Table 16 report the means for the digit span, List Memory Task and computerized motor tracking achieved by the VaD patients, healthy young and elderly subjects.

Table 16. Mean performances on computerized version of the dual task for study groups

		Digit span	List Memory Task				Motor Tracking	
			Digits recalled correctly		Lists recalled correctly		% accuracy score	
Subjects			Single	Dual	Single	Dual	Single	Dual
young	Mean	5.23	.92011	.86591	.81343	.69292	56.103	55.493
	SD	(.71)	(.08)	(.08)	(.16)	(.20)	(7.45)	(7.21)
old	Mean	4.65	.90687	.88863	.80099	.73563	50.100	46.835
	SD	(.75)	(.08)	(.08)	(.17)	(.19)	(4.30)	(6.43)
VaD	Mean	3.69	.92017	.85443	.81753	.69315	49.467	42.460
	SD	(.95)	(.08)	(.09)	(.13)	(.19)	(8.71)	(12.08)

To determine the effect of dual task on performance of List Memory Task (using digits recalled correctly and lists recalled correctly respectively) and motor tracking, the data from the single and dual tasks were entered separately into a 3 (group) × 2 (condition – type of task: single vs. dual) ANOVA. For the List Memory Task - digits recalled correctly, the ANOVA showed a significant effect of condition, $F(1,62)=18.727$, $MSE = .003$, $p<.0001$. There was no effect of group ($F<1$) and no interaction. For the List Memory Task - lists recalled correctly the ANOVA showed a significant effect of condition, $F(1,60)=25.511$, $MSE = .012$, $p<.0001$. There was no effect of group and no interaction ($F<1$). For the computerised motor tracking task the ANOVA showed a significant effect of condition, $F(1,62)=24.042$, $MSE=16.005$, $p<.0001$; of group $F(2,62)=11.595$, $MSE=94.389$, $p<.0001$ and an interaction $F(2,62)=5.608$, $MSE=16.005$, $p<.006$ (Figure 1). Post hoc analysis (Bonferroni) showed significant difference between the young participants and elderly subjects ($p<.001$) and young participants and the VaD patients ($p<.0001$), but the older and the VaD patient groups did not differ (Figure 9).

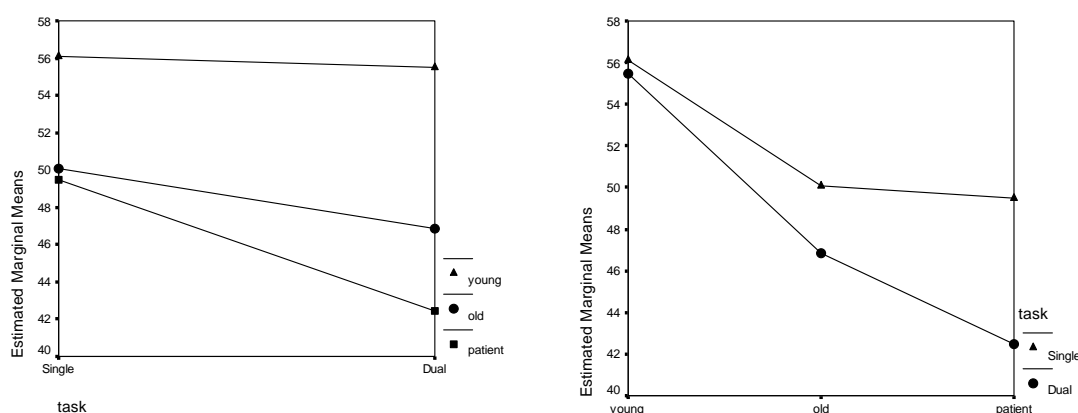

Figure 9. The motor tracking task performance by VaD patients, healthy young and elderly subjects.

To find an overall measure of dual task performance again percentage change and combined percentage change scores were calculated for each participant.

Three percentage change scores were calculated: for the List Memory Task digits recalled correctly, for the List Memory Task lists recalled correctly and for the perceptuomotor tracking task. Table 17 presents these three percentage change scores.

Table 17. The percentage change scores for the computerised version of the dual-task.

		Percentage change for the digits recalled correctly	Percentage change for the lists recalled correctly	Percentage change for the motor tracking
young	Mean	5.4443	14.3357	.5873
	Number of participants	26	26	26
	Std. Deviation	9.409	20.833	10.375
	Minimum	-13.20	-30.00	-34.09
	Maximum	20.11	50.00	15.88
old	Mean	1.6179	6.1943	6.3522
	Number of participants	26	24	26
	Std. Deviation	9.690	26.744	11.208
	Minimum	-23.72	-92.00	-14.23
	Maximum	31.53	60.61	34.62
VaD	Mean	7.0759	16.4600	15.4945
	Number of participants	13	13	13
	Std. Deviation	6.979	15.434	14.116
	Minimum	-2.52	-2.98	-6.60
	Maximum	21.85	48.72	45.81

A one-way ANOVA was performed on percentage change scores to find significant differences between three study groups. There was no statistically significant difference between means of the three study groups in percentage change scores for the List Memory task digits recalled correctly or lists recalled correctly. A significance differences was found for the motor tracking percentage change score $F(2, 62) = 7.298$; $p < .001$. Post hoc analysis (Bonferroni) showed a significant difference between the VaD patients and young subjects ($p < .001$), whereas the difference between the elderly group and the VaD patients was significant at one tail ($p = .068$).

The two combined percentage change *mu* scores were calculated for each participant. One was calculated for digits recalled correctly and another for the list recalled correctly. Means of these scores are presented in the Table 18 and Figure 10.

Table 18. The combined percentage change *mu* scores for computerised version of the dual-task.

		Digits recalled correctly	Lists recalled correctly
young	Mean	96.9842	92.5385
	Number of participants	26	26
	Std. Deviation	7.336	11.426
	Minimum	86.02	73.67
	Maximum	112.49	113.96
old	Mean	96.0149	94.3754
	Number of participants	26	24
	Std. Deviation	7.096	14.138
	Minimum	80.43	65.89
	Maximum	107.41	141.55
VaD	Mean	88.7148	84.0227
	Number of participants	13	13
	Std. Deviation	8.004	10.889
	Minimum	75.32	65.94
	Maximum	99.91	96.31

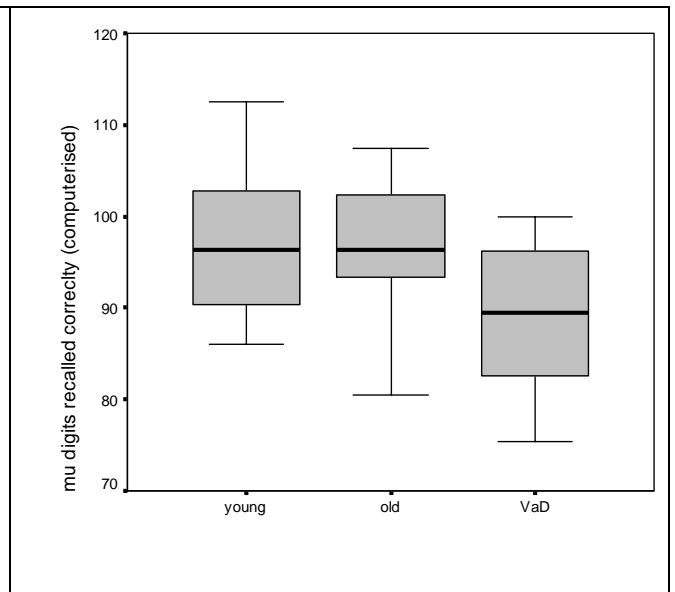
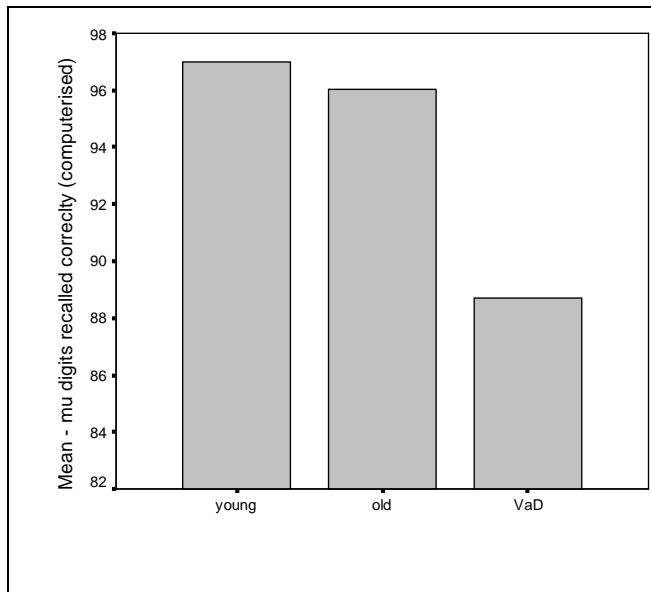

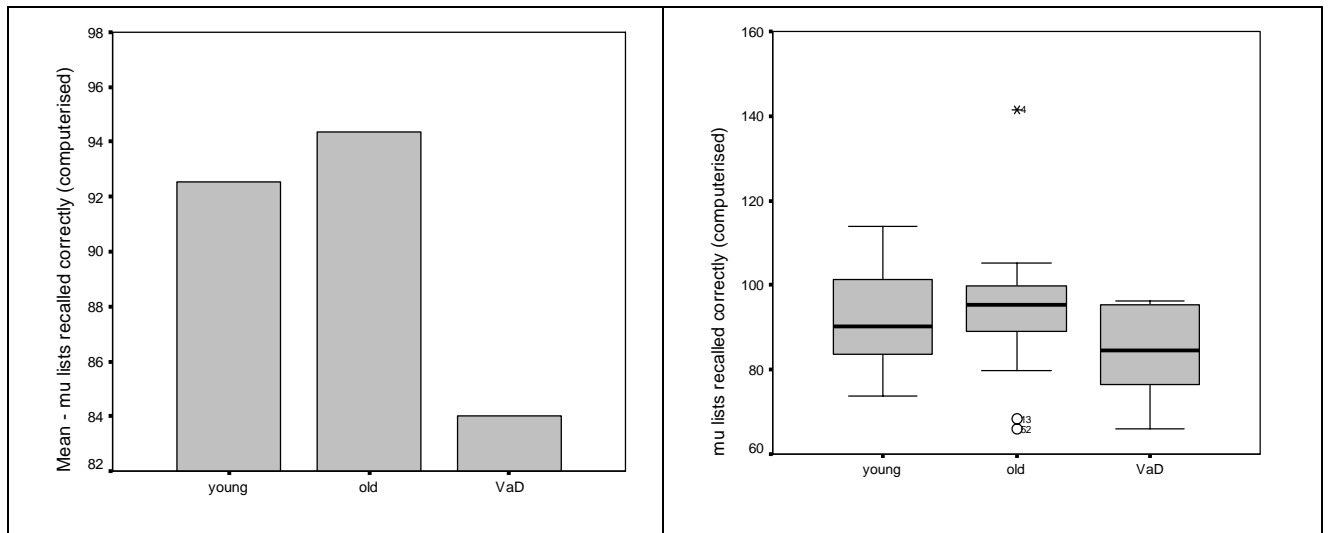
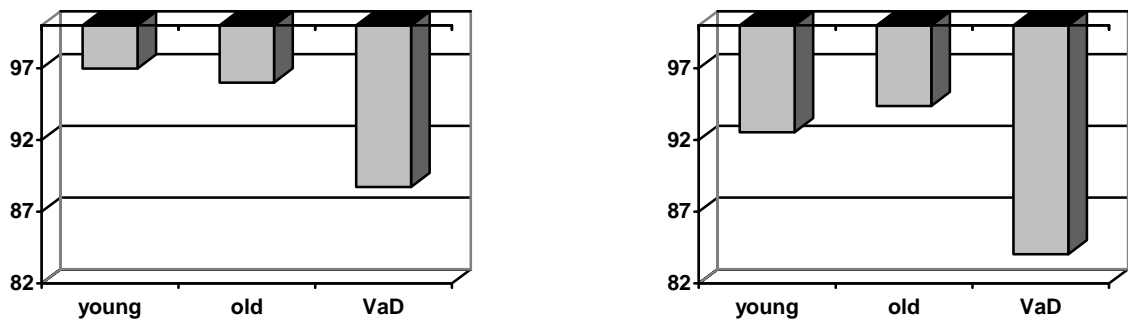

Figure 10. The means of *mu* scores for VaD patients, young and elderly participants.

The combined percentage change *mu* scores using digits recalled correctly data for young subjects showed a decrement of 3.02%, for old subjects a decrement of 3.99% and for the VaD patients a decrement of 11.29%. The combined percentage change scores using lists recalled correctly data for the young subjects showed a decrement of 7.46%, for the old subjects a decrement of 5.62% and for the VaD patients a decrement of 15.98% (Figure 11).



a. Digits recalled correctly

b. Lists recalled correctly

Figure 11. The combined percentage change *mu* scores for computerised version of the dual-task.

A one-way ANOVA was performed on combined percentage change scores to assess significant differences between three study groups. A statistically significant difference was found between means of the three study groups in percentage change scores for the List Memory task digits recalled correctly $F(2, 62) = 5.905; p < .004$. Post hoc analysis (Bonferroni) showed a significant difference between the VaD patients and young subjects ($p < .005$) and the VaD patients and elderly participants ($p < .015$), whereas the difference between elderly and young groups was not significant. The significance of mean differences for the percentage change scores using the List

Memory task lists recalled correctly was significant at one tail $F(2, 60) = 3.08$; $p < .053$. Post hoc analysis (Bonferroni) showed no significant difference between the VaD patients and young subjects and young and elderly participants, whereas the difference between elderly subjects and the VaD patients was significant at one tail ($p < .056$).

12.3.1.2. The paper and pencil version of the dual-task.

Table 19 reports the means of the digit span, List Memory Task and paper and pencil motor tracking for VaD patients, healthy young and elderly subjects.

Table 19. Mean performances on paper and pencil version of the dual task for study groups

		Digit span	List Memory Task				Motor Tracking	
			Digits recalled correctly		Lists recalled correctly		% accuracy score	
Subjects			Single	Dual	Single	Dual	Single	Dual
young	Mean	5.23	.92011	.92447	.81343	.81270	193.62	186.58
	SD	(.71)	(.08)	(.06)	(.16)	(.15)	(22.29)	(29.65)
old	Mean	4.65	.90687	.94153	.80099	.86529	149.12	143.96
	SD	(.75)	(.08)	(.07)	(.17)	(.16)	(29.50)	(29.83)
VaD	Mean	3.69	.92017	.86789	.81753	.73503	98.62	78.38
	SD	(.95)	(.08)	(.12)	(.13)	(.21)	(32.96)	(29.57)

To determine the effect of dual task on performance of List Memory Task (using digits recalled correctly and lists recalled correctly) and motor tracking, the data from the single and dual tasks were entered separately into a 3 (group) \times 2 (condition – type of task: single vs. dual) ANOVA. For the List Memory Task - digits recalled correctly, the ANOVA showed a significant effect of group by condition interaction, $F(2,60)=4.187$, $MSE = .003$, $p < .02$. There was no effect of group or condition ($F < 1$) (Figure 12a). For the List Memory Task - lists recalled correctly, the ANOVA showed a significant effect of group by condition interaction, $F(2,60)=4.434$, $MSE = .01$, $p < .016$. There was no effect of group or condition ($F < 1$) (Figure 12b). For the paper and pencil motor tracking task the ANOVA showed a significant effect of condition, $F(1,60)=11.873$, $MSE=282.122$, $p < .001$ and of group $F(2,60)=66.894$, $MSE=1358.116$, $p < .0001$. There was no effect of group by condition interaction (Figure 12b). Post hoc analysis (Bonferroni) showed significant difference between the young participants and elderly subjects ($p < .0001$), young participants and the VaD patients ($p < .0001$) and elderly participants and the VaD patients ($p < .0001$) (Figure 13).

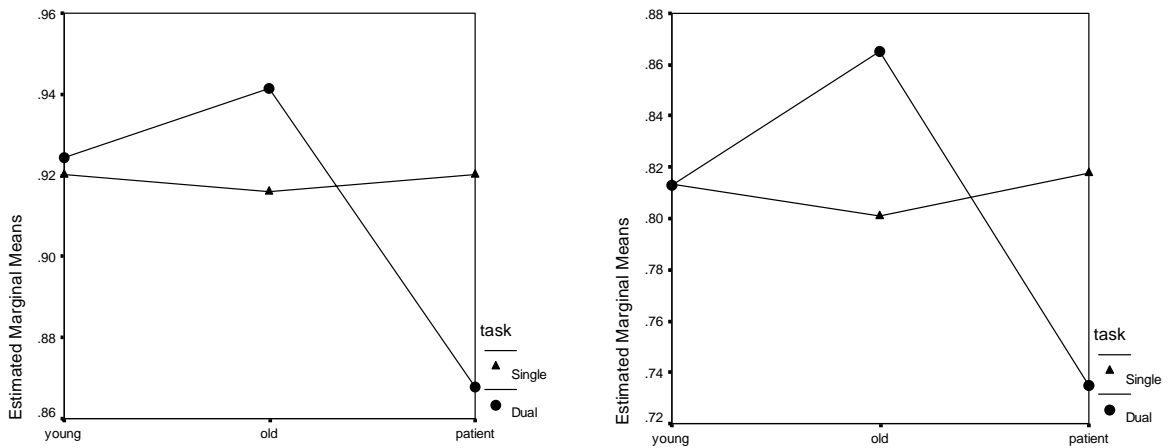

a. Digits recalled correctly.

b. Lists recalled correctly.

Figure 12. The List Memory task performance by VaD patients, healthy young and elderly subjects – a. digits recalled correctly; b. lists recalled correctly.

As an overall measure of dual task performance again percentage change and combined percentage change *mu* scores were calculated for each participant.

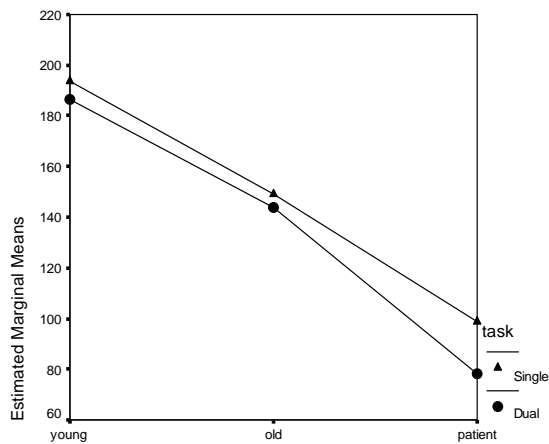

Figure 13. The paper and pencil motor tracking task performance by VaD patients, healthy young and elderly subjects.

Again three percentage change scores were calculated: for the List Memory Task digits recalled correctly, for the List Memory Task lists recalled correctly and for the perceptuomotor tracking task. Table 20 presents these three percentage change scores.

Table 20. The percentage change scores for the paper and pencil version of the dual-task.

		Percentage change for the digits recalled correctly	Percentage change for the lists recalled correctly	Percentage change for the motor tracking
young	Mean	-1.1390	-2.0568	3.6217
	Number of participants	26	26	26
	Std. Deviation	10.277	21.526	10.877
	Minimum	-36.54	-66.67	-16.48
	Maximum	15.72	40.00	38.46

old	Mean	-3.2368	-11.5693	1.8446
	Number of participants	24	24	24
	Std. Deviation	9.923	31.411	18.714
	Minimum	-39.54	-140.00	-30.08
	Maximum	8.77	22.62	44.67
VaD	Mean	5.9224	11.6064	20.7032
	Number of participants	13	13	13
	Std. Deviation	8.545	16.520	14.848
	Minimum	-6.36	-10.83	-8.62
	Maximum	25.47	46.67	42.86

A one-way ANOVA was performed on percentage change scores to find significant differences between three study groups. A statistically significant difference was found between means of the three study groups in percentage change scores for the all three percentage change scores: List Memory task digits recalled correctly $F(2, 62) = 7.298$; $p < .029$, List Memory task lists recalled correctly $F(2, 60) = 7.298$; $p < .032$ and motor tracking $F(2, 60) = 7.298$; $p < .001$. Post hoc analysis (Bonferroni) for the List Memory task digits recalled correctly showed a significant difference between the VaD patients and elderly subjects ($p < .026$), whereas the difference between elderly group and young subjects and young subjects and VaD patients were not significant. Post hoc analysis (Bonferroni) for the List Memory task lists recalled correctly showed the same results as was found for the post hoc analysis (Bonferroni) for the List Memory task digits recalled correctly. Post hoc analysis (Bonferroni) for the motor tracking task List showed a significant difference between the VaD patients and young subjects ($p < .004$) and the VaD patients and elderly subjects ($p < .002$), whereas the difference between elderly group and young participants was not significant.

The two combined percentage change *mu* scores were calculated for each participant. One was calculated for digits recalled correctly and another for the list recalled correctly. The means of these scores are presented in the Table 21 and Figure 14.

Table 21. The combined percentage change *mu* scores for paper and pencil version of the dual-task.

		Digits recalled correctly	Lists recalled correctly
young	Mean	98.7587	99.2175
	Number of participants	26	26
	Std. Deviation	7.704	12.603
	Minimum	72.91	60.77
	Maximum	115.43	130.50

old	Mean	100.6961	104.8623
	Number of participants	24	24
	Std. Deviation	11.397	19.661
	Minimum	78.69	78.66
	Maximum	130.18	180.42
VaD	Mean	86.6872	83.8452
	Number of participants	13	13
	Std. Deviation	9.104	12.220
	Minimum	75.32	62.67
	Maximum	104.44	104.69

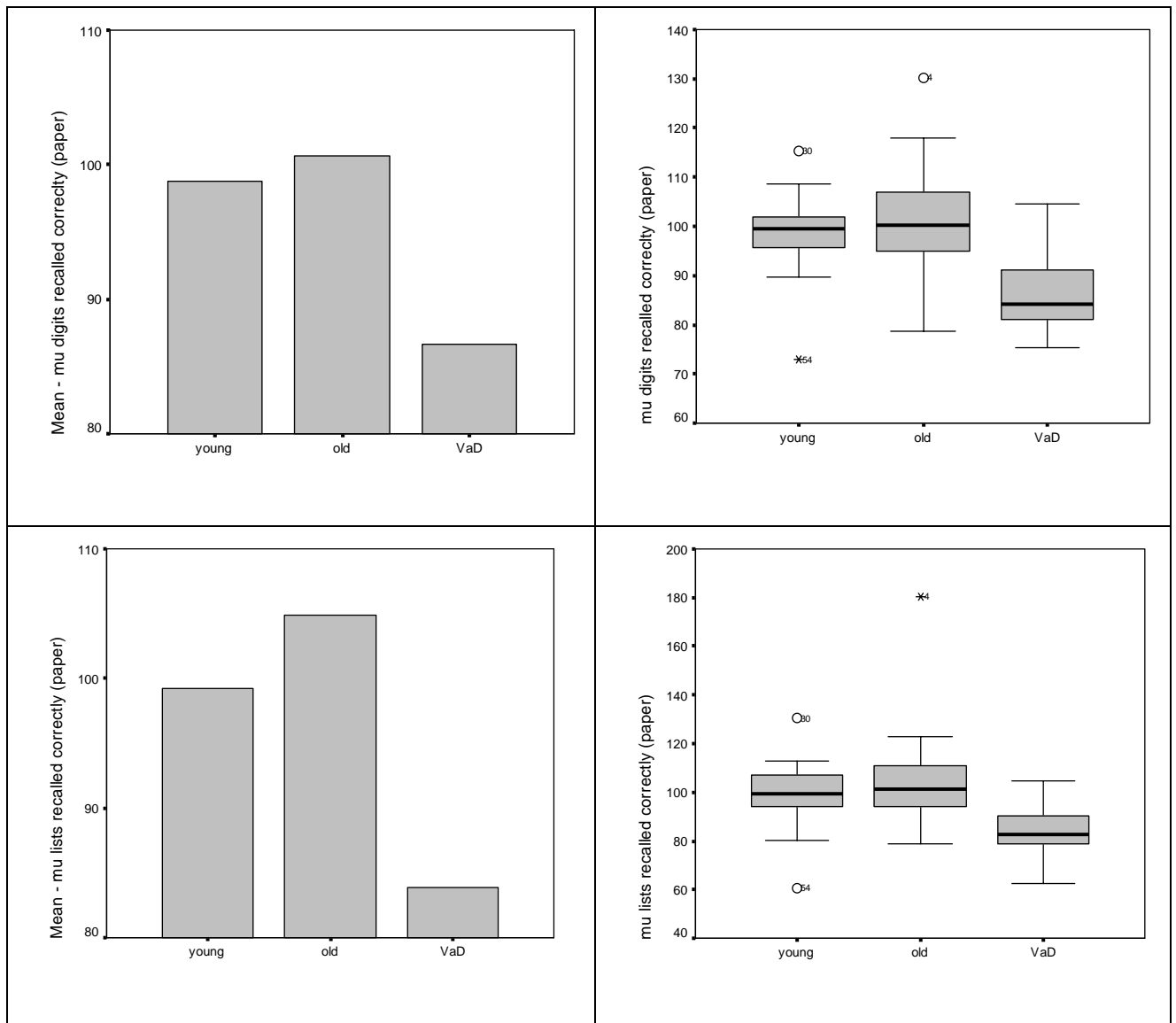
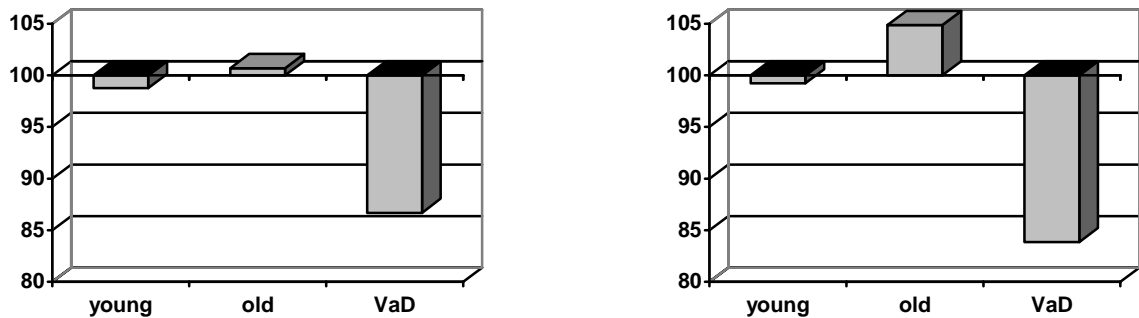

Figure 14. The means of *mu* scores for VaD patients, young and elderly participants.

The combined percentage change scores using digits recalled correctly data for young subjects showed a decrement of 1.24%, for old subjects an increment of .70% and for the VaD patients a

decrement of 13.31% (Figure 15a). The combined percentage change scores using lists recalled correctly data for the young subjects showed a decrement of .78%, for the old subjects an increment of 4.86% and for the VaD patients a decrement of 16.15% (Figure 15b).



a. Digits recalled correctly

b. Lists recalled correctly

Figure 15. The combined percentage change *mu* scores for paper and pencil version of the dual-task.

A one-way ANOVA was performed on combined percentage change *mu* scores to find significant differences between three study groups. The statistically significant difference was found between the means of the three study groups in percentage change scores for the List Memory task digits recalled correctly $F(2, 60) = 9.83$; $p < .0001$. Post hoc analysis (Bonferroni) showed a significant difference between the VaD patients and young subjects ($p < .001$) and the VaD patients and elderly participants ($p < .0001$), whereas the difference between elderly and young groups was not significant. The statistically significant difference was found between the means of the three study groups in percentage change scores for the List Memory task lists recalled correctly $F(2, 60) = 7.72$; $p < .001$. Post hoc analysis (Bonferroni) showed a significant difference between the VaD patients and young subjects ($p < .016$) and the VaD patients and elderly participants ($p < .001$), whereas the difference between elderly and young groups was not significant.

12.3.2. The dual-task performance by VaD patients and age and education matched healthy elderly participants.

To make clear if VaD patients' performance is worse than the healthy elderly participants' performance under dual-task condition, only data for these two groups were entered into the statistical analysis.

12.3.2.1. The computerised version of the dual-task.

Table 22 reports the means of the digit span, List Memory Task and computerized motor tracking for VaD patients and healthy elderly participants.

Table 22. Mean performances on computerized version of the dual task for study groups

		Digit span	List Memory Task				Motor Tracking	
			Digits recalled correctly		Lists recalled correctly		% accuracy score	
Subjects			Single	Dual	Single	Dual	Single	Dual
old	Mean	4.65	.90687	.88863	.80099	.73563	50.1001	46.8352
	<i>SD</i>	(.75)	(.08)	(.08)	(.17)	(.19)	(4.30)	(6.43)
VaD	Mean	3.69	.92017	.85443	.81754	.69315	49.4667	42.4597
	<i>SD</i>	(.95)	(.08)	(.09)	(.14)	(.19)	(8.71)	(12.08)

To determine the effect of dual task on performance of List Memory Task (using digits recalled correctly and lists recalled correctly respectively) and motor tracking, the data from the single and dual tasks were entered separately into a 2 (group) × 2 (condition – type of task: single vs. dual) ANOVA. For the List Memory Task - digits recalled correctly, the ANOVA showed a significant effect of condition, $F(1,37)=9.679$, $MSE = .003$, $p < .004$. There was no effect of group ($F < 1$). The effect of group by condition interaction was significant at one tail $F(1,37)=3.096$, $MSE = .003$, $p < .087$. For the List Memory Task - lists recalled correctly, the ANOVA showed a significant effect of condition, $F(1,35)=13.684$, $MSE = .011$, $p < .001$. There was no effect of group ($F < 1$) and no interaction. For the computerised motor tracking task the ANOVA showed a significant effect of condition, $F(1,37)=28.03$, $MSE=16.312$, $p < .0001$. There was no effect of group. The effect of group by condition an interaction was significant at one tail $F(1,37)=3.72$, $MSE =16.312$, $p < .061$.

As an overall measure of dual-task performance percentage change and combined percentage change *mu* scores were calculated for each participant.

Three percentage change scores were calculated: for the List Memory Task digits recalled correctly, for the List Memory Task lists recalled correctly and for the perceptuomotor tracking task. Table 23 presents these three percentage change scores.

Table 23. The percentage change scores for the computerised version of the dual-task.

		Percentage change for the digits recalled correctly	Percentage change for the lists recalled correctly	Percentage change for the motor tracking
old	Mean	1.6179	6.1943	6.3522
	Number of participants	26	24	26
	Std. Deviation	9.690	26.744	11.208
	Minimum	-23.72	-92.00	-14.23
	Maximum	31.53	60.61	34.62

VaD	Mean	7.0759	16.4600	15.4945
	Number of participants	13	13	13
	Std. Deviation	6.979	15.434	14.116
	Minimum	-2.52	-2.98	-6.60
	Maximum	21.85	48.72	45.81

There was no statistically significant difference found the two study groups for percentage change scores using the List Memory Task digits recalled correctly and lists recalled correctly. For the List Memory Task lists recalled correctly difference between the means on percentage change scores for the two study groups was significant at one tail $t(37) = -1.805$; $p < .079$. A significant difference was found on percentage change score for the motor tracking task performance $t(37) = -2.201$, $p < .034$. The VaD patients showed significantly higher change in performance under dual-task condition than the group of elderly participants.

The two combined percentage change *mu* scores were calculated for the paper and pencil version of the dual-task. One was calculated for digits recalled correctly and another for the list recalled correctly. Means of these scores are presented in the Table 24 and Figure 16.

Table 24. The combined percentage change *mu* scores for computerised version of the dual-task.

		Digits recalled correctly	Lists recalled correctly
old	Mean	96.0149	94.3754
	Number of participants	26	24
	Std. Deviation	7.096	14.138
	Minimum	80.43	65.89
	Maximum	107.41	141.55
VaD	Mean	88.7148	84.0227
	Number of participants	13	13
	Std. Deviation	8.004	10.889
	Minimum	75.32	65.94
	Maximum	99.91	96.31

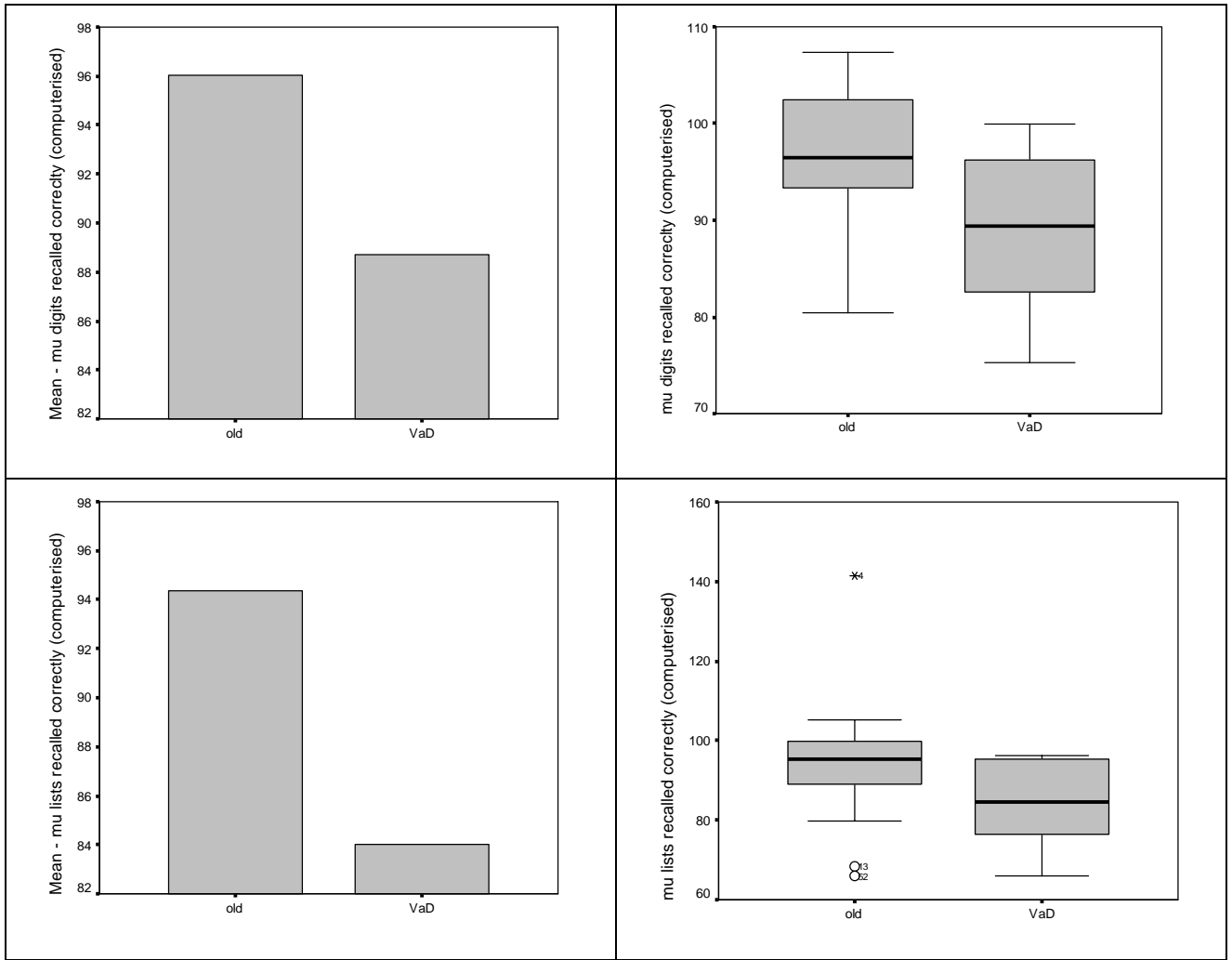
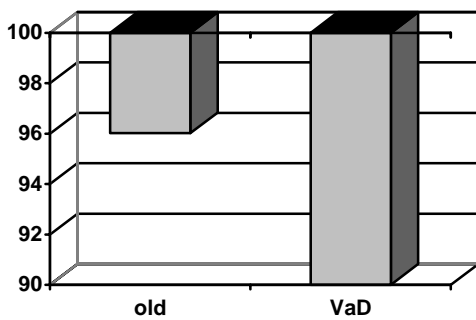
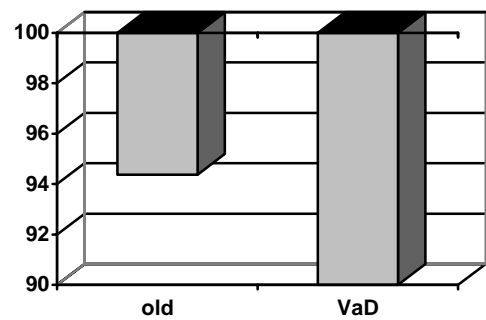

Figure 16. The means of μ scores for VaD patients and elderly participants.

For the combined percentage change μ scores using digits recalled correctly data for old subjects showed a slight decrement of 3.99% and for the VaD patients of 11.29% (Figure 17a). For the combined percentage change scores using lists recalled correctly data old subjects showed a small decrement of 5.62% and for the VaD patients of 15.98% (Figure 17b).



a. Digits recalled correctly



b. Lists recalled correctly

Figure 17. The combined percentage change μ scores for computerised version of the dual-task.

A statistically significant difference was found between the means of the two study groups on combined percentage change score for the List Memory Task digits recalled correctly $t(37)=2.903$, $p<.006$ and for the List Memory Task lists recalled correctly $t(35)=2.292$, $p<.028$. For both scores VaD patients showed significantly more decrement than healthy elderly participants.

12.3.2.2. The paper and pencil version of the dual-task.

Table 25 reports the means for the digit span, List Memory Task and paper and pencil motor tracking achieved by the VaD patients and healthy elderly participants.

Table 25. Mean performances on paper and pencil version of the dual task for study groups

Subjects		Digit span	List Memory Task				Motor Tracking	
			Digits recalled correctly		Lists recalled correctly		% accuracy score	
			Single	Dual	Single	Dual	Single	Dual
old	Mean	4.65	.90687	.94153	.80099	.86529	149.12	143.96
	SD	(.75)	(.08)	(07)	(.17)	(.16)	(29.50)	(29.83)
VaD	Mean	3.69	.92017	.86789	.81754	.73503	98.62	78.38
	SD	(.95)	(.08)	(.12)	(.13)	(.21)	(32.96)	(29.57)

To determine the effect of dual task on performance of List Memory Task (using digits recalled correctly and lists recalled correctly respectively) and motor tracking, the data from the single and dual tasks were entered separately into a 2 (group) \times 2 (condition – type of task: single vs. dual) ANOVA. For the List Memory Task - digits recalled correctly, the ANOVA showed a significant effect of group by condition interaction $F(1,35)=8.605$, $MSE =.003$, $p<.006$. There was no effect of type of task and no effect of group (Figure 18a). For the List Memory Task - lists recalled correctly, the ANOVA showed a significant effect of group by condition interaction $F(1,35)=8.409$, $MSE =.011$, $p<.006$. There was no effect of type of task and no effect of group (Figure 18b). For the paper and pencil motor tracking task the ANOVA showed a significant effect of condition, $F(1,35)=8.269$, $MSE=328.881$, $p<.007$ and of group $F(1,35)=37.879$, $MSE=1499.881$, $p<.007$. The effect of group by condition interaction was significant at one tail $F(1,35)=2.909$, $MSE =328.881$, $p<.097$.

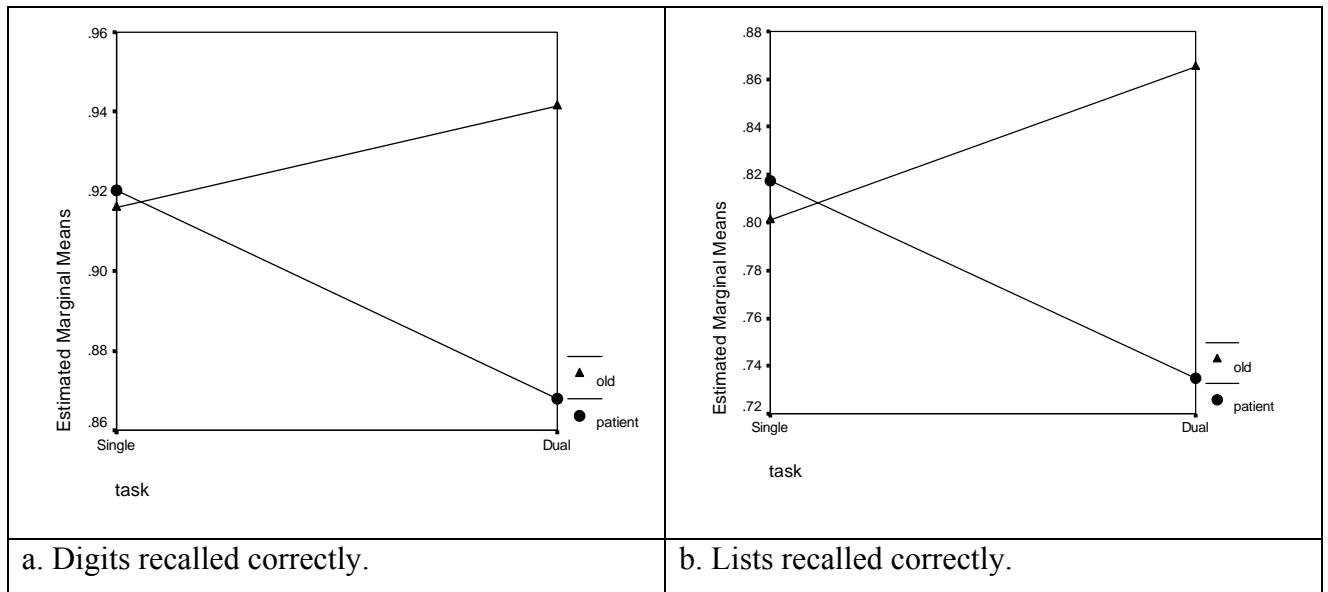

Figure 18. The List Memory task performance by VaD patients and elderly participants – a. digits recalled correctly; b. lists recalled correctly.

As an overall measure of dual task performance percentage change and combined percentage change *mu* scores were calculated for each participant.

Three percentage change scores were calculated: for the List Memory Task digits recalled correctly, for the List Memory Task lists recalled correctly and for the perceptuomotor tracking task. Table 26 presents these three percentage change scores.

Table 26. The percentage change scores for the paper and pencil version of the dual-task.

		Percentage change for the digits recalled correctly	Percentage change for the lists recalled correctly	Percentage change for the motor tracking
old	Mean	-3.2368	-11.5693	1.8446
	Number of participants	24	24	24
	Std. Deviation	9.923	31.411	18.714
	Minimum	-39.54	-140.00	-30.08
	Maximum	8.77	22.62	44.67
VaD	Mean	5.9224	11.6064	20.7032
	Number of participants	13	13	13
	Std. Deviation	8.545	16.520	14.848
	Minimum	-6.36	-10.83	-8.62
	Maximum	25.47	46.67	42.86

A statistically significant difference were found between the means of the two study groups on all three percentage change scores: for digits recalled correctly $t(35) = -2.808$; $p < .008$; for lists recalled correctly $t(35) = -2.471$; $p < .018$ and for the motor tracking $t(35) = -3.132$; $p < .003$. The all three percentage change scores for the elderly group were higher than for VaD patients.

The two combined percentage change *mu* scores were calculated for the paper and pencil version of the dual-task. One was calculated for digits recalled correctly and another for the list recalled correctly. Means of these scores are presented in the Table 27 and Figure 19.

Table 27. The combined percentage change *mu* scores for paper and pencil version of the dual-task.

		Digits recalled correctly	Lists recalled correctly
old	Mean	100.6961	104.8623
	Number of participants	24	24
	Std. Deviation	11.39738	19.66089
	Minimum	78.69	78.66
	Maximum	130.18	180.42
VaD	Mean	86.6872	83.8452
	Number of participants	13	13
	Std. Deviation	9.10358	12.22034
	Minimum	75.32	62.67
	Maximum	104.44	104.69

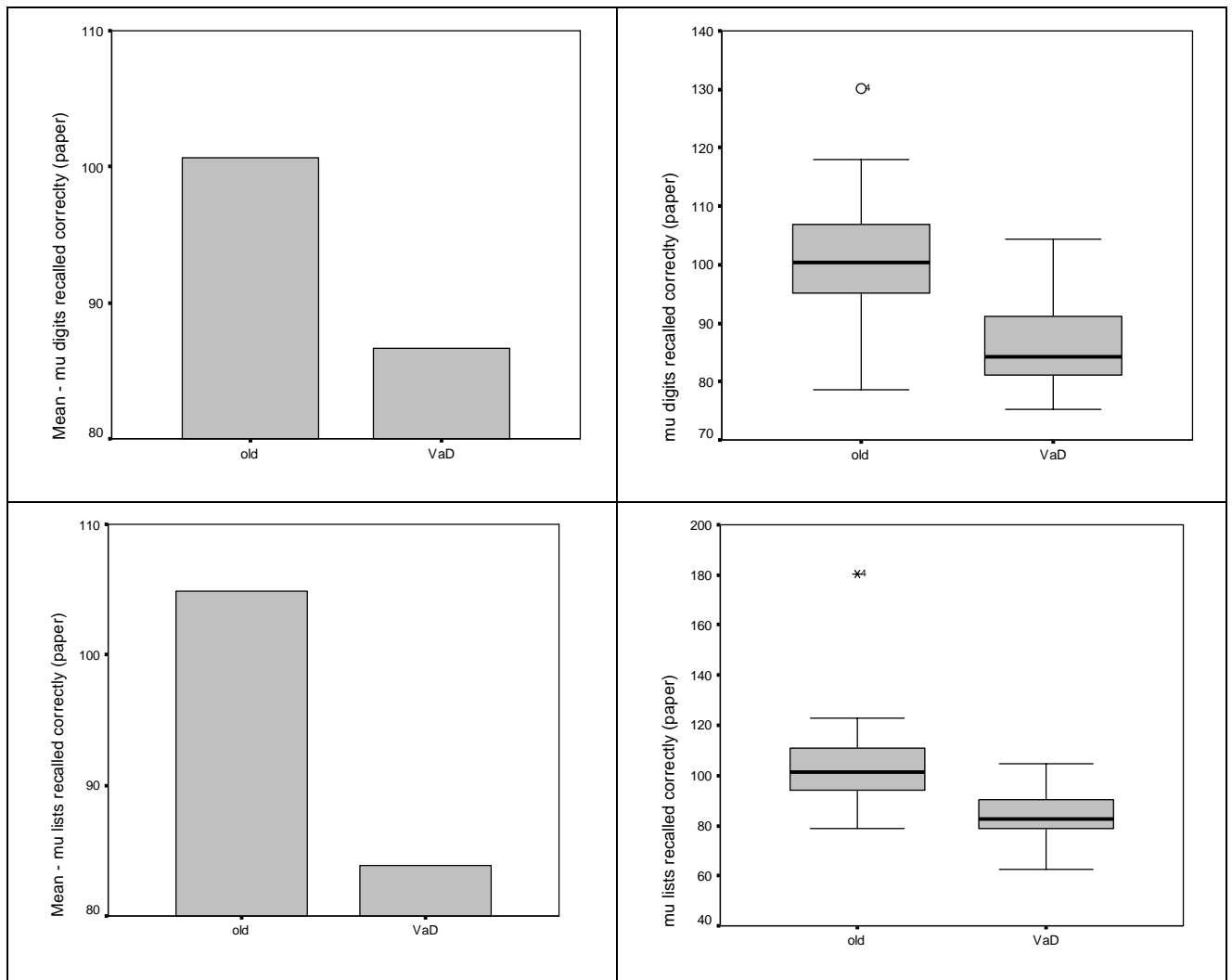
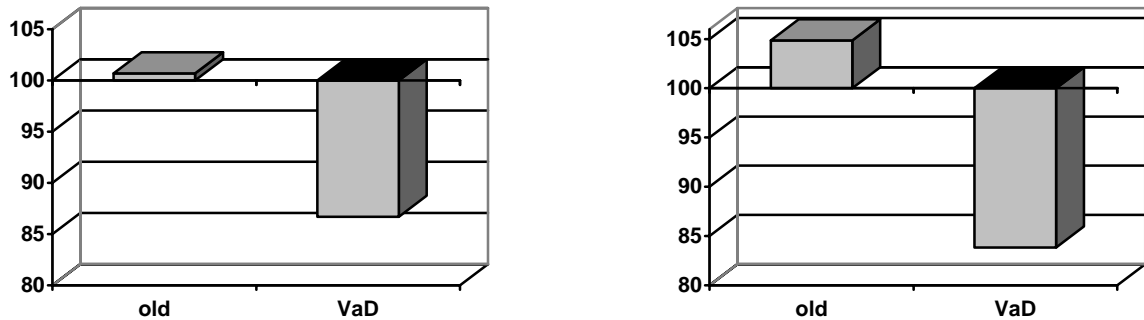

Figure 19. The means of *mu* scores for VaD patients and elderly participants.

For the combined percentage change *mu* scores using digits recalled correctly data for the old subjects showed a slight increment of .70% and for the VaD patients a decrement of 13.31% (Figure 20a). For the combined percentage change scores using lists recalled correctly data old subjects showed a small increment of 4.86% and VaD patients a decrement of 16.15% (Figure 20b).



a. Digits recalled correctly

b. Lists recalled correctly

Figure 20. The combined percentage change *mu* scores for paper and pencil version of the dual-task.

A statistically significant difference was found between the means of the two study groups on combined percentage change *mu* score for the List Memory Task digits recalled correctly $t(35)=3.814, p<.001$ and for the List Memory Task lists recalled correctly $t(35)=3.493, p<.001$. The group of elderly participants didn't showed decrements on combined percentage change scores, while VaD patients showed a significant decrement.

To determine whether the VaD patients show the similar or different magnitude of overall dual-task performance decrement as was found in AD patients in the previous study (Logie et al., 2004), the mean decrement on computerised dual-tasks *mu* score – lists recalled correctly for the VaD patients in the presents study 15.98% was compared to the computerised – lists recalled correctly *mu* score mean decrement shown by the AD patients in the previous study, which was 17.90%. No statistically significant differences were found for the decrements of the VaD patients on the computerised dual-task – lists recalled correctly *mu* score $t(12)= -.637; p=5.36$ ns. in comparison to AD patients' overall dual-task decrement (Figure 21).

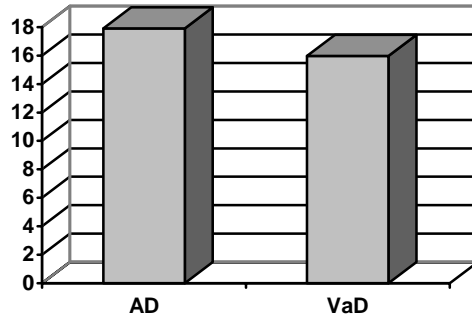

Figure 21. The combined percentage change μ scores for computerised version of the dual-task – lists recalled correctly for AD and VaD patients.

12.3.3. The correlation of the test-retest and of the computerised – paper and pencil versions of the dual-task.

To assess the test-retest reliability of the combined percentage change scores μ , correlations between the computerised and the paper and pencil dual-task μ scores were found separately for the young participants, for the elderly group and the VaD patients (Table 13, Table 14 and Table 15 respectively). In tables 13-18 the sign ** indicates that the correlation is significant at the 0.01 level (2-tailed). The sign * indicates that the correlation is significant at the 0.05 level (2-tailed).

The young subjects showed high significant test-retest reliability for the computerised ($r=.73$, $p<.0001$; $r=.70$, $p<.0001$) and the paper and pencil ($r=.78$, $p<.0001$; $r=.74$, $p<.0001$) dual-task μ scores (Table 28).

Table 28. Correlation of the test-retest dual task μ scores for the young participants.

The μ scores					
		Computerised (digits recalled correctly)	Computerised (lists recalled correctly)	Paper and pencil (digits recalled correctly)	Paper and pencil (lists recalled correctly)
Retest - computerised (digits recalled correctly)	Pearson Correlation	.732(**)	.630(**)	.387	.477(*)
	Sig. (2-tailed)	.0001	.001	.051	.014
	Number of participants	26	26	26	26
Retest - computerised (lists recalled correctly)	Pearson Correlation	.576(**)	.703(**)	.157	.312(*)
	Sig. (2-tailed)	.002	.0001	.129	.010
	Number of participants	26	26	26	26
Retest - paper and pencil (digits recalled correctly)	Pearson Correlation	.334	.238	.777(**)	.702(**)
	Sig. (2-tailed)	.096	.242	.0001	.0001
	Number of participants	26	26	26	26
Retest - paper and pencil (lists recalled correctly)	Pearson Correlation	.263	.338	.721(**)	.735(**)
	Sig. (2-tailed)	.096	.242	.0001	.0001
	Number of participants	26	26	26	26

The elderly participants also showed a high test-retest reliability in performance of the computerised ($r=.66$, $p<.0001$; $r=.69$, $p<.0001$) and paper and pencil ($r=.90$, $p<.0001$; $r=.94$, $p<.0001$) versions of dual-task (Table 29).

Table 29. Correlation of the test-retest dual task *mu* scores for the old participants.

The <i>mu</i> scores					
		Computerised (digits recalled correctly)	Computerised (lists recalled correctly)	Paper and pencil (digits recalled correctly)	Paper and pencil (lists recalled correctly)
Retest - computerised (digits recalled correctly)	Pearson Correlation	.663(**)	.567(**)	.261	.297
	Sig. (2-tailed)	.0001	.004	.218	.158
	Number of participants	26	24	24	24
Retest - computerised (lists recalled correctly)	Pearson Correlation	.592(**)	.685(**)	.149	.332
	Sig. (2-tailed)	.002	.0001	.486	.113
	Number of participants	24	24	24	24
Retest - paper and pencil (digits recalled correctly)	Pearson Correlation	.334	.383	.902(**)	.821(**)
	Sig. (2-tailed)	.111	.065	.0001	.0001
	Number of participants	24	24	24	24
Retest - paper and pencil (lists recalled correctly)	Pearson Correlation	.304	.575(**)	.824(**)	.940(**)
	Sig. (2-tailed)	.149	.003	.0001	.0001
	Number of participants	24	24	24	24

The VaD patients also showed a high test-retest reliability in performance of the computerised ($r=.78$, $p<.002$; $r=.61$, $p<.026$) and paper and pencil ($r=.80$, $p<.001$; $r=.75$, $p<.003$) versions of dual-task (Table 30).

Table 30. Correlation of the test-retest dual task *mu* scores for the VaD patients.

The <i>mu</i> scores					
		Computerised (digits recalled correctly)	Computerised (lists recalled correctly)	Paper and pencil (digits recalled correctly)	Paper and pencil (lists recalled correctly)
Retest - computerised (digits recalled correctly)	Pearson Correlation	.775(**)	.762(**)	.289	.250
	Sig. (2-tailed)	.002	.002	.337	.411
	Number of participants	13	13	13	13
Retest - computerised (lists recalled correctly)	Pearson Correlation	.451	.612(*)	.148	.193
	Sig. (2-tailed)	.122	.026	.630	.528
	Number of participants	13	13	13	13
Retest - paper and pencil (digits recalled correctly)	Pearson Correlation	.449	.533	.799(**)	.760(**)
	Sig. (2-tailed)	.124	.061	.001	.003
	Number of participants	13	13	13	13

Retest - paper and pencil (lists recalled correctly)	Pearson Correlation	.404	.576(*)	.702(**)	.748(**)
	Sig. (2-tailed)	.171	.039	.007	.003
	Number of participants	13	13	13	13

The correlation analysis was performed on the *mu* scores of the computerised and paper and pencil versions of the dual-task separately for young participants, for the elderly group and the VaD participants to find out whether these two versions of the dual task are comparable counterparts of each other (Table 31). For the young participants a high significant correlation was found for the two computerised *mu* scores ($r=.84$, $p<.0001$). A slightly higher significant correlation was found for the two paper and pencil *mu* scores ($r=.94$, $p<.0001$). A relatively small significant correlation was found between the *mu* scores for the computerised and paper and pencil versions of the dual task that include the List Memory Task – lists recalled correctly ($r=.45$, $p<.02$). The correlation between the *mu* scores for the computerised and paper and pencil versions of the dual task that include the List Memory Task – digits recalled correctly was significant at one tail ($r=.37$, $p<.066$).

Table 31. Correlation of the computerised and paper and pencil dual task *mu* scores for the young participants.

The <i>mu</i> scores					
		Computerised (digits recalled correctly)	Computerised (lists recalled correctly)	Paper and pencil (digits recalled correctly)	Paper and pencil (lists recalled correctly)
Computerised (digits recalled correctly)	Pearson Correlation	1	.882(**)	.299(*)	.410(**)
	Sig. (2-tailed)	.	.0001	.020	.001
	Number of participants	63	60	60	60
Computerised (lists recalled correctly)	Pearson Correlation	.882(**)	1	.367(**)	.519(**)
	Sig. (2-tailed)	.0001	.	.004	.0001
	Number of participants	60	60	60	60
Paper and pencil (digits recalled correctly)	Pearson Correlation	.299(*)	.367(**)	1	.914(**)
	Sig. (2-tailed)	.020	.004	.	.0001
	Number of participants	60	60	60	60
Paper and pencil (lists recalled correctly)	Pearson Correlation	.410(**)	.519(**)	.914(**)	1
	Sig. (2-tailed)	.001	.0001	.0001	.
	Number of participants	60	60	60	60

For the old participants the high significant correlations was found for the two computerised *mu* scores ($r=.80$, $p<.0001$). A slightly higher significant correlation was found for the two paper and pencil *mu* scores ($r=.88$, $p<.0001$). A relatively small significant correlation was found between the *mu* scores for the computerised and paper and pencil versions of the dual task that include the List Memory Task – lists recalled correctly ($r=.56$, $p<.004$). The correlation between the *mu* scores

for the computerised and paper and pencil versions of the dual task that include the List Memory Task – digits recalled correctly was not significant (Table 32).

Table 32. Correlation of the computerised and paper and pencil dual task *mu* scores for the old participants.

The <i>mu</i> scores					
		Computerised (digits recalled correctly)	Computerised (lists recalled correctly)	Paper and pencil (digits recalled correctly)	Paper and pencil (lists recalled correctly)
Computerised (digits recalled correctly)	Pearson Correlation	1	.889(**)	.277(*)	.335(**)
	Sig. (2-tailed)	.	.0001	.029	.008
	Number of participants	64	62	62	62
Computerised (lists recalled correctly)	Pearson Correlation	.889(**)	1	.341(**)	.492(**)
	Sig. (2-tailed)	.0001	.	.007	.0001
	Number of participants	62	62	62	62
Paper and pencil (digits recalled correctly)	Pearson Correlation	.277(*)	.341(**)	1	.915(**)
	Sig. (2-tailed)	.029	.007	.	.0001
	Number of participants	62	62	62	62
Paper and pencil (lists recalled correctly)	Pearson Correlation	.335(**)	.492(**)	.915(**)	1
	Sig. (2-tailed)	.008	.0001	.0001	.
	Number of participants	62	62	62	62

For the VaD patients high significant correlations was found for the two computerised *mu* scores ($r=.89$, $p<.0001$). A slightly higher significant correlation was found for the two paper and pencil *mu* scores ($r=.94$, $p<.0001$). No significant correlations were found between the *mu* scores for the computerised and paper and pencil versions of the dual task that include the List Memory Task – lists recalled correctly and the List Memory Task – digits recalled correctly (Table 33).

Table 33. Correlation of the computerised and paper and pencil dual task *mu* scores for the VaD participants.

The <i>mu</i> scores					
		Computerised (digits recalled correctly)	Computerised (lists recalled correctly)	Paper and pencil (digits recalled correctly)	Paper and pencil (lists recalled correctly)
Computerised (digits recalled correctly)	Pearson Correlation	1	.891(**)	.359	.320
	Sig. (2-tailed)	.	.0001	.228	.287
	Number of participants	13	13	13	13
Computerised (lists recalled correctly)	Pearson Correlation	.891(**)	1	.344	.399
	Sig. (2-tailed)	.0001	.	.249	.177
	Number of participants	13	13	13	13

Paper and pencil (digits recalled correctly)	Pearson Correlation	.359	.344	1	.937(**)
	Sig. (2-tailed)	.228	.249	.	.0001
	Number of participants	13	13	13	13
Paper and pencil (lists recalled correctly)	Pearson Correlation	.320	.399	.937(**)	1
	Sig. (2-tailed)	.287	.177	.0001	.
	Number of participants	13	13	13	13

The *mu* scores were calculated for each of the thirteen VaD patients to assess their individual overall dual-task performances (Table 34). The *mu* score of the VaD patients were compared to the norms of *mu* scores – the means and intervals with $M \pm 2SD$ boundaries that were defined using data of the 64 healthy elderly participants. The VaD patients were divided into two groups according to dementia severity levels determined by the MMSE scores. The group of the mild VaD patients consisted of patients with the MMSE score higher than 20 and the moderate VaD patients consisted of patients with the MMSE score less than 20.

Table 34. The *mu* scores of 13 VaD patients.

Patient ID	Computerised <i>mu</i> - digits recalled correctly	Computerised <i>mu</i> - lists recalled correctly	Paper and pencil <i>mu</i> - digits recalled correctly	Paper and pencil <i>mu</i> - lists recalled correctly	MMSE severity
33	89.43	85.23	76	62.67	moderate
39	75.32	70.77	83.18	78.64	moderate
48	97.55	95.35	104.4	104.69	mild
53	79.38	65.94	75.68	70.24	moderate
64	92.56	93.26	96.84	95.99	mild
66	96.21	96.31	83.67	82.72	mild
67	85.75	82.11	97.89	101.25	mild
70	97.65	96.25	81.16	80.84	mild
74	90.04	84.64	84.31	85.37	moderate
92	88.13	70.35	91.21	80.74	moderate
138	78.74	76.58	87.89	90.13	moderate
147	82.63	79.68	75.32	70.48	mild
148	99.91	95.83	89.34	86.22	mild

It was found that for the computerised *mu* score – digits recalled correctly only one moderate VaD patient (7.69% of the VaD patients) fell outside the low boundary of the normative interval (Figure 22). For the computerised *mu* score – lists recalled correctly all VaD patients fell within the

limits of the normative interval (Figure 23). For the paper and pencil *mu* score – digits recalled correctly three VaD patients (23.08% of the VaD patients) one mild and two moderate VaD patients fell outside the low boundary of the normative interval (Figure 24). For the paper and pencil *mu* score – lists recalled correctly seven VaD patients (53.85% of the VaD patients) – three mild and four moderate fell outside the low boundary of the normative interval (Figure 25).

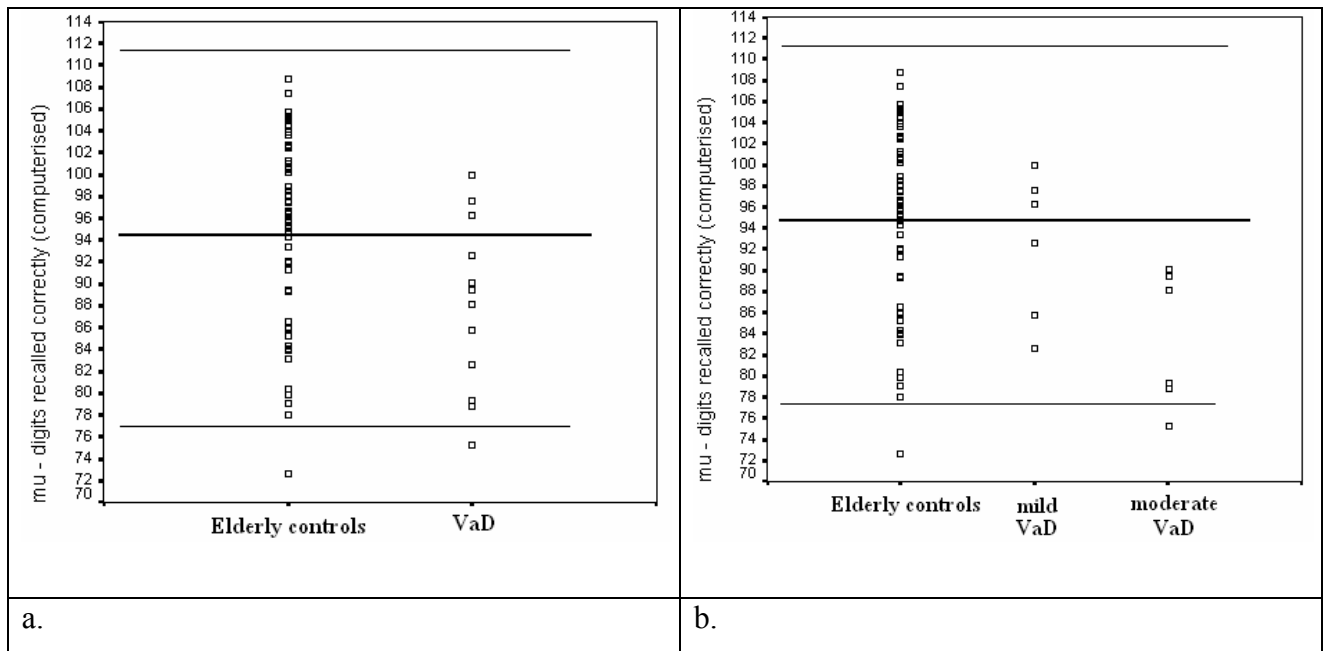

Figure 22. The individual computerised *mu* scores – digits recalled correctly for a. the elderly participants and VaD patients, b. the elderly participants and the mild and moderate VaD patients.

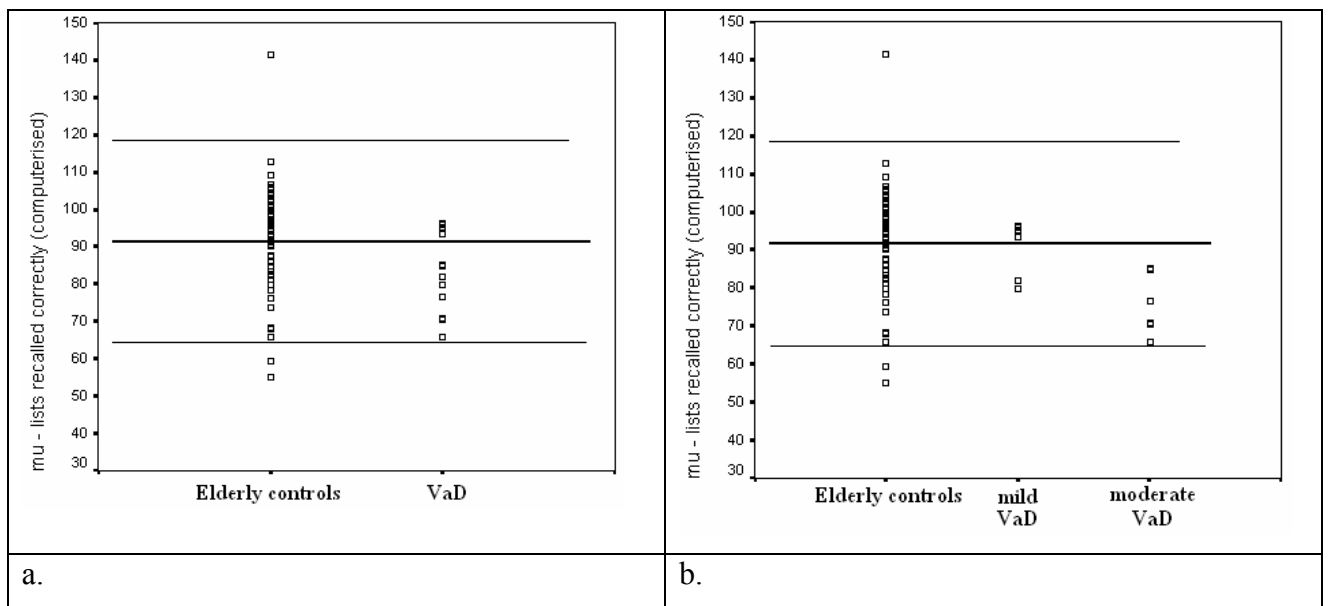

Figure 23. The individual computerised *mu* scores – lists recalled correctly for a. the elderly participants and VaD patients, b. the elderly participants and the mild and moderate VaD patients.

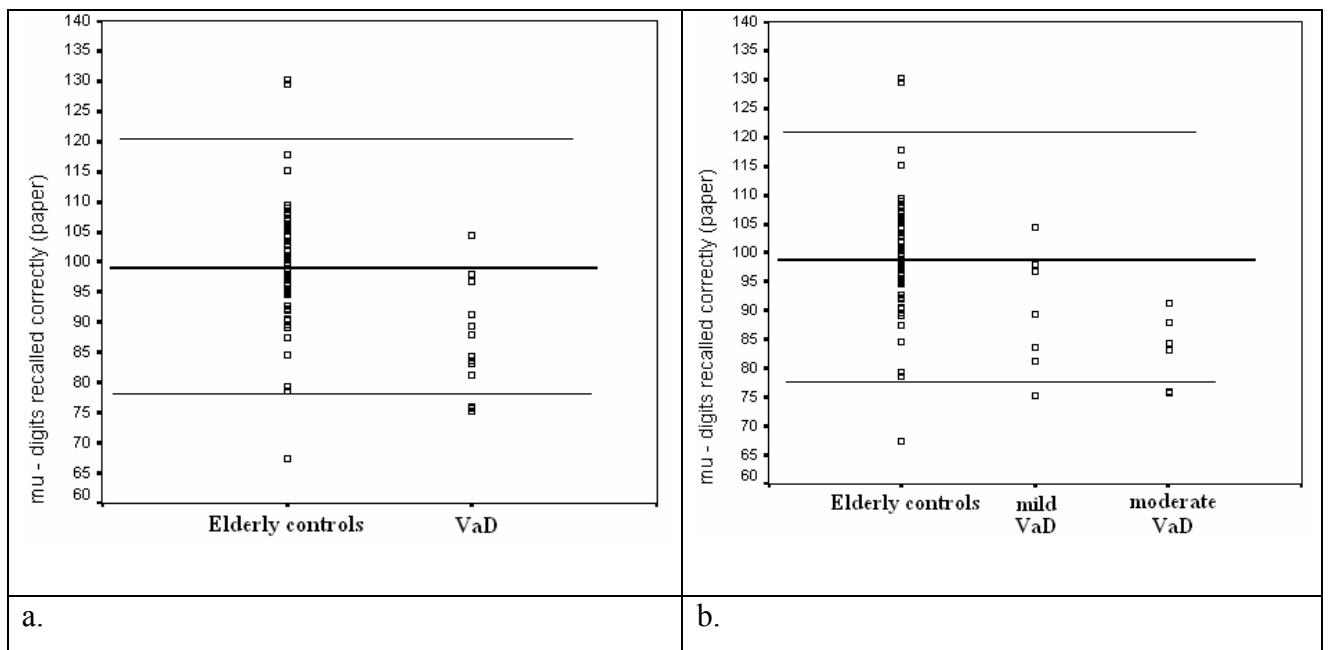

Figure 24. The individual paper and pencil *mu* scores – digits recalled correctly for a. the elderly participants and VaD patients, b. the elderly participants and the mild and moderate VaD patients.

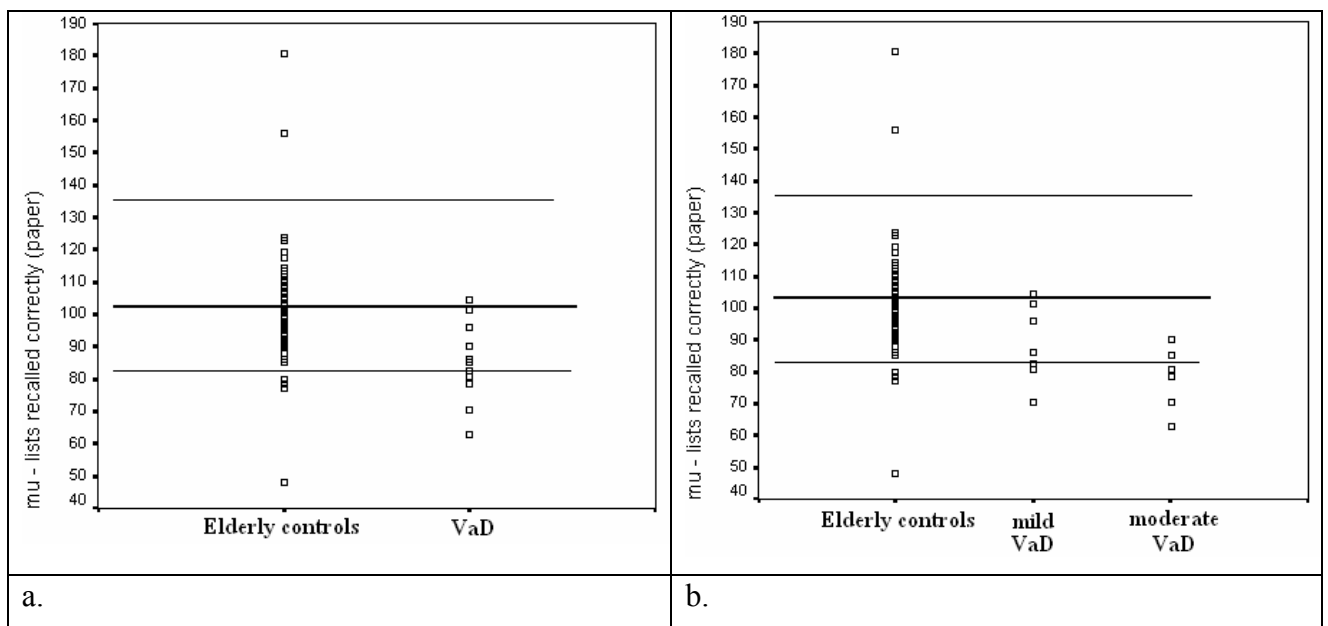

Figure 25. The individual paper and pencil *mu* scores – lists recalled correctly for a. the elderly participants and VaD patients, b. the elderly participants and the mild and moderate VaD patients.

12.4. Discussion

Experiment 2 showed a significant effect of the type of task for all three computerised verbal and motor tasks, significant group effect and group by condition interaction for the motor tracking task, when three study groups were analysed. The performance of young participants was

significantly different from performance of the VaD patients and elderly participants, but the VaD patients' and the elderly group's performance did not differ. The overall change in performance of the study groups across both tasks and the trade-offs in performance between tasks was examined by analysing percentage change and combined percentage change *mu* scores. No significant differences were detected in performance between study groups for the percentage change scores using computerised List Memory task – digits recalled correctly and List Memory task – lists recalled correctly data. Only the percentage change scores for the computerised motor tracking were significantly different between the study groups. The change in performance under dual-task condition was significantly different between the group of young participants and VaD patients. The groups of the young and elderly participants did not differ in performance change under dual-task condition, but difference between VaD patients and elderly group was significant at one tail.

A significant difference was found between the combined percentage change scores for the three study groups using Lists Memory task - digits recalled correctly. The combined percentage change score for the computerised version of the dual-task using Lists Memory task - digits recalled correctly showed significantly greater decrement under dual-task condition for VaD patients in comparison to young and elderly participants who did not differ from each other. These results are similar to those findings for AD patients according to which the AD group showed substantial dual-task impairment that was not present in healthy controls.

The difference between the combined percentage change scores using Lists Memory task - lists recalled correctly was significant at one tail. The combined percentage change score for the computerised version of the dual-task using Lists Memory task - lists recalled correctly showed significant differences in performance under dual-task condition between the groups of young and elderly participants and young participants and VaD patients, but the difference between performance of the elderly group and VaD patients was significant at one tail. This result shows that VaD patients' performance is not robustly different from the performance of the healthy elderly participants as was shown in the case of AD patients, when the same Lists Memory task - lists recalled correctly measurement procedure was used.

Since it is very important to find out whether decrement in performance under dual-task condition is different between VaD patients and healthy elderly participants and thus dual-task is the paradigm which can differentiate VaD cognitive functioning deterioration from the healthy elderly performance, only the data of these two groups was analysed. The significant effect of the type of task was detected for all three computerised verbal and motor tasks. For the Lists Memory task - digits recalled correctly and computerised motor tracking task the effect of group by condition interaction was significant at one tail. No significant effect of group was detected for all

three computerised tasks. The significant difference was found on percentage change scores between VaD patients and elderly participants for the motor task performance. The VaD patients showed significantly high change in performance under dual-task condition. The significant differences were found on the two computerised combined percentage change scores for the elderly group and VaD patients. The performance of the elderly group was significantly better than VaD patients' performance under dual-task condition.

These results confirmed that using a computerised version of the dual-task, VaD patients show a decrement in comparison to healthy controls under dual-task condition, but this was not as robust as was found for the AD patients.

The significant effect of group by condition interaction was found for the Lists Memory task - digits recalled correctly and Lists Memory task - lists recalled correctly using a paper and pencil dual-task paradigm for all three study groups. A significant effect of type of task and group was detected for the paper and pencil motor tracking task. All three groups were significantly different from each other on motor tracking performance. The statistically significant difference was found on percentage change scores for all three paper and pencil verbal and motor tasks. The VaD patients showed significantly high performance decrement on verbal tasks in comparison to the elderly group under dual-task condition, but the young group did not differ from the other two groups significantly on percentage change scores. A significantly high decrement in motor tracking performance was shown by VaD patients in comparison to both healthy controls' groups. Healthy controls did not differ significantly from each other on motor tracking performance change.

A significant overall dual-task performance change was detected on the two combined percentage change scores for three study groups. For both paper and pencil *mu* scores VaD patients showed significant decrement in overall performance under dual-task condition compared to healthy participants. The *mu* scores of the young and elderly groups did not differ significantly.

To find stronger evidence for the existence of difference in performance for healthy elderly participants and VaD patients under dual-task condition, only data of these two groups was analysed using the paper and pencil dual-task paradigm. Again a significant effect of group by condition interaction was found for the two verbal tasks. The significant effect of type of task and group was found for the paper and pencil motor tracking task. The main effect of group by condition interaction was significant at one tail. Significant differences were shown on all three percentage change scores for these two groups. The VaD patients showed higher performance change than the healthy elderly participants under dual-task condition for all three percentage change scores.

Significant differences were found for the combined percentage change scores on the paper and pencil dual-task paradigm between the VaD patients and healthy elderly participants. The VaD patients showed significant decrement on overall performance under dual-task condition in comparison to the healthy elderly group for both *mu* scores.

The comparison of the magnitude of the overall dual-task performance decrements shown by the VaD and AD patients confirmed that VaD patients show similar marked decrease in performance under dual-task condition in comparison to healthy controls.

The computerised and paper and pencil versions of the dual-task showed significant high reliability coefficients for all three study groups, while comparing test-retest performance of the study participants.

The correlation analysis showed moderate significant correlation between *mu* scores (lists recalled correctly) of the computerised and paper and pencil versions of dual-task for healthy controls, but not for the group of VaD patients. This finding together with essentially the same results shown using these two versions of dual-task indicates that a paper and pencil version of the dual-task is a comparable counterpart of the computerised version of the dual-task.

The comparison of the VaD patients' individual performances to the defined norms showed that despite the statistically significant decrements in performance under dual-task condition in comparison to the healthy controls, the great majority of the VaD patients still performed in the limits defined for the performance of the healthy elderly participants.

It is important to study AD patients under dual-task condition and investigate whether their *mu* scores and decrement/increment on *mu* scores also fall within the limits of normative interval. This can be a study issue for future research.

13. Experiment 3

Dual-task and Memory Performance of VaD

13.1. Aims

For the clinical management of different types of dementia it is important to make an etiological diagnosis, particularly to distinguish between AD, VaD and other forms of dementia. The assessment of different cognitive domains is an integral part in obtaining information to make differential diagnosis, for the prescription of drugs and the maintenance of those patients taking them. It still remains unanswered which cognitive domain is specific or common to the different types of dementia. As was found in Experiment 2 and other studies (Graham et al., 2004) the executive function disturbance could be a shared pathology for AD and VaD. It was found that AD

patients performed more poorly than VaD patients on the memory tests, but it is still unclear if there is differential disturbance of executive functioning and of memory (episodic memory and working memory span) performance in VaD. Experiment 3 addressed the issue of differential disturbance of executive functioning and memory performance in VaD. Particularly Experiment 3 aims at:

a) Investigating whether there is a differential disturbance of episodic memory performance and central executive functioning, particularly performance of a dual-task paradigm in VaD patients in comparison to 1) age and education matched healthy elderly and education matched young participants, and 2) only age and education matched healthy elderly subjects;

b) Investigating whether working memory capacity (working memory span) determines performance on the dual-task paradigm and whether the relationship between working memory capacity and the dual-task performance is different for VaD patients in comparison to 1) age and education matched healthy elderly and education matched young participants, and 2) only age and education matched healthy elderly subjects;

c) Determining norms for episodic memory and working memory span (WMS) performance for the Georgian elderly population.

d) Comparing deviations from the norms on dual-task and episodic memory performance for the VaD patients.

13.2. Methods

Participants

In Experiment 3 the same participants' data and selection criteria were used as in Experiment 2.

Tasks

In Experiment 3 the same computerised and paper and pencil dual-task were considered as in Experiment 2.

The MMSE, WMS and the two WMS-III subtests - the Verbal Paired Associates task and the Word Lists task were also administered to participants. The presentation of episodic memory tasks was constant across participants – the Verbal Paired Associates task was always administered first and the Word Lists task second.

Procedure

In Experiment 3 the general experimental procedure presented at the beginning of the experimental part of this study was used (see page 62).

13.3. Results

13.3.1. The dual-task and episodic memory.

13.3.1.1. Performance of the VaD patients, age and education matched healthy elderly and education matched young participants.

Table 35 reports the means of the learning slopes and the episodic memory scores for the Verbal Paired Associates (VPA) task and the Word Lists Learning (WLL) task for the VaD patients, healthy young and elderly participants (Figure 26).

Table 35. Mean performances on the memory tasks for study groups

Subjects		Learning slope VPA	Learning slope WLL	Episodic memory VPA	Episodic memory WLL
young	Mean	4.0000	4.0769	88.8095	83.1294
	<i>SD</i>	2.245	2.096	16.529	19.628
old	Mean	2.5200	4.7600	61.1286	49.7045
	<i>SD</i>	2.084	1.855	40.562	29.519
VaD	Mean	.6154	2.0769	19.2308	5.3846
	<i>SD</i>	1.193	1.754	38.397	14.500

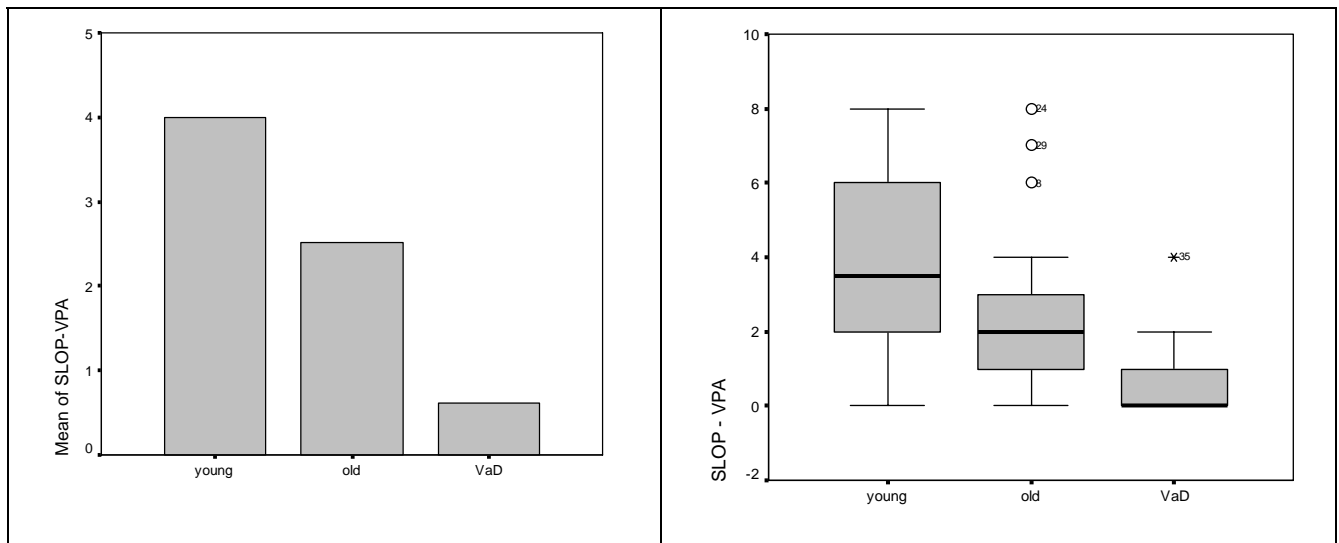

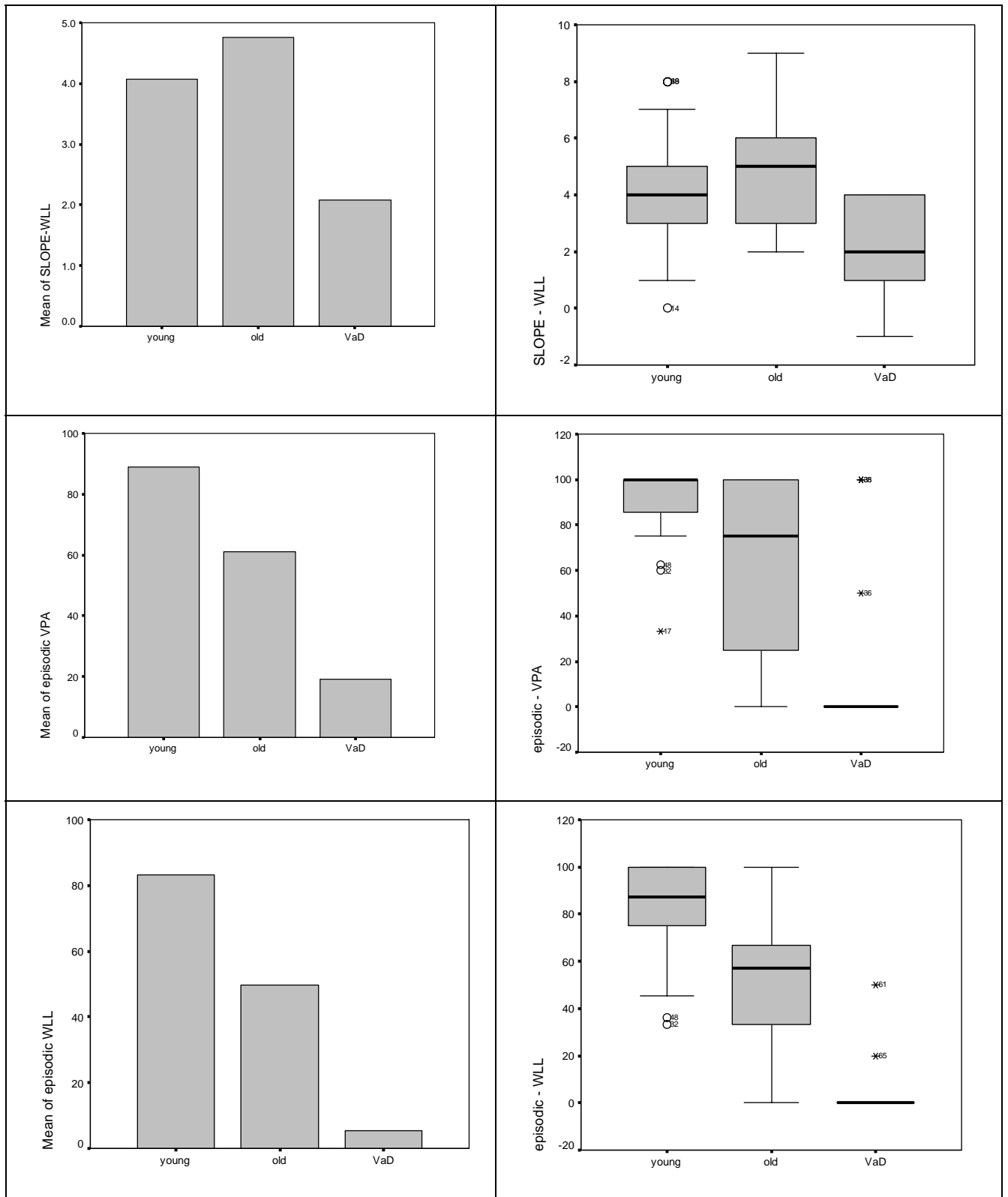

Figure 26. The means of memory scores for VaD patients, young and elderly participants.

To determine differences in the learning process and the episodic memory of the three study groups, the data of the four memory scores were entered into a one-way ANOVA. Statistically significant differences were detected on all four memory scores for the study groups: for the learning slope of the VPA task $F(2, 61) = 12.476, p < .0001$, for the learning slope of the WLL task

$F(2, 61) = 8.302, p < .001$, for the episodic memory score of the VPA task $F(2, 61) = 20.139, p < .0001$ and for the episodic memory score of the WLL task $F(2, 61) = 49.109, p < .0001$. Post hoc analysis (Bonferroni) for the learning slope of the VPA task showed significant differences between all three groups: young and elderly participants ($p < .033$), young participants and VaD patients ($p < .0001$) and elderly participants and VaD patients ($p < .022$). Post hoc analysis (Bonferroni) for the learning slope of the WLL task showed significant differences between the young participants and the VaD patients ($p < .011$) and elderly participants and VaD patients ($p < .0001$), whereas the difference between young and elderly participants was not significant. Post hoc analysis (Bonferroni) for the episodic memory score of the VPA task showed significant differences between all three groups: young and elderly participants ($p < .01$), young participants and VaD patients ($p < .0001$) and elderly participants and VaD patients ($p < .001$). Post hoc analysis (Bonferroni) for the episodic memory score of the WLL task showed significant differences between all three groups: young and elderly participants ($p < .0001$), young participants and VaD patients ($p < .0001$) and elderly participants and VaD patients ($p < .0001$).

For all four memory scores the mean performance of young participants was higher than of elderly participants and elderly participants performance was significantly higher than of VaD patients.

Different error scores were calculated for the VPA and WLL tasks taking into account type of intrusion errors. For each individual VPA task error scores for contaminations, confabulations, perseverations and overall error score (which took into account all three types of intrusions) was calculated. The error score for each single type of intrusion was defined as the sum of that type of intrusion over all 4 trials and delayed trial divided by 5 (the number of trials) and multiplied by 100. The overall error score was defined as the sum of all three types of intrusions in all five trials divided by 5 and multiplied by 100.

Table 36 reports the means of the four error scores for the three study groups (Figure 27).

Table 36. The means of error scores of VPA task for the study groups.

		Error scores of VPA task			
Subjects		Contaminations	Confabulations	Perseverations	The overall error score for the VPA
young	Number of participants	5	0	1	5
	Mean	72		80	88
	<i>SD</i>	75.631			85.557

old	Number of participants	13	1	3	13
	Mean	76.92	20	20	83.08
	<i>SD</i>	43.086		.000	46.795
VaD	Number of patients	3	1	0	3
	Mean	33.33	180		93.33
	<i>SD</i>	23.094			94.516

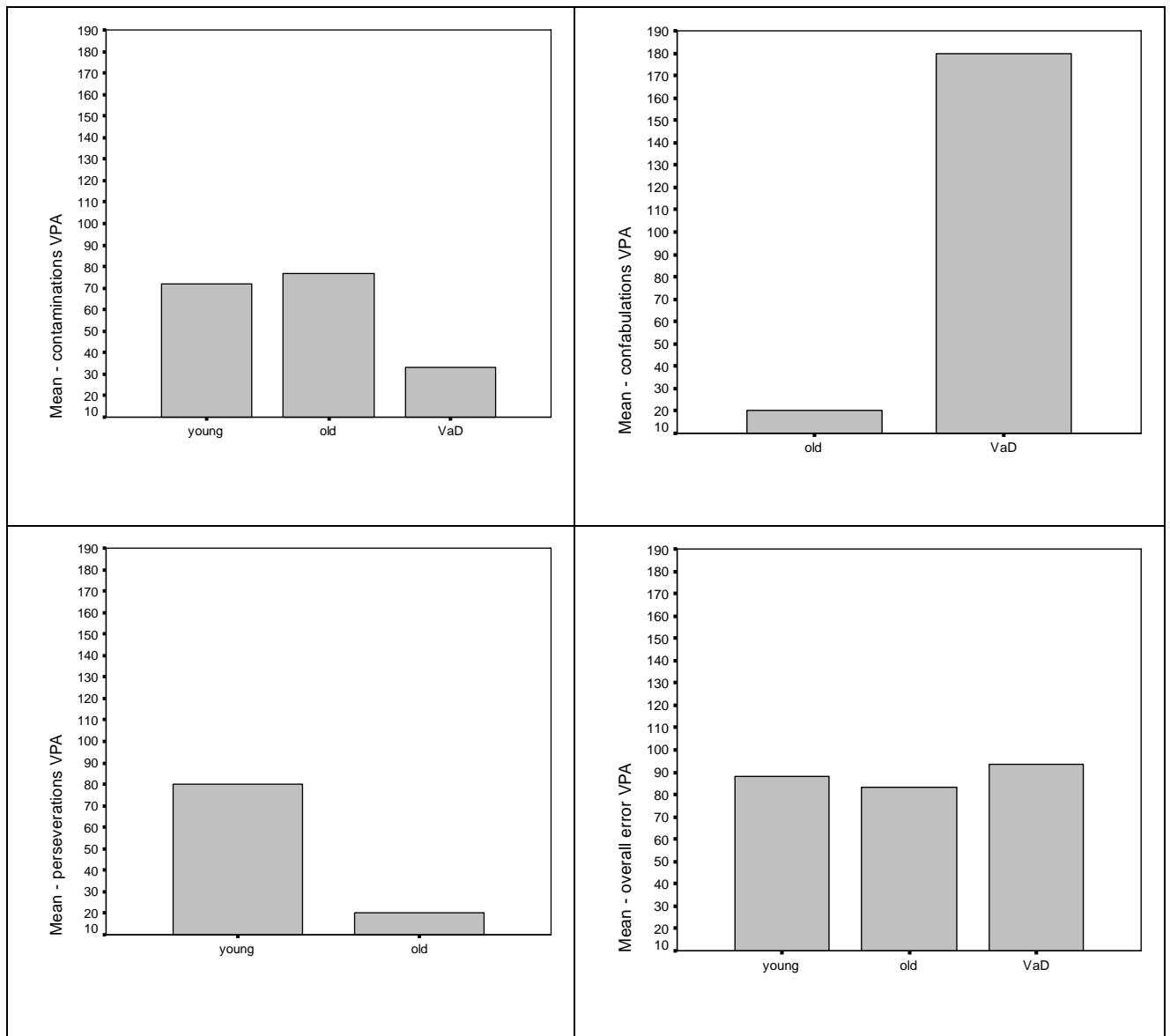
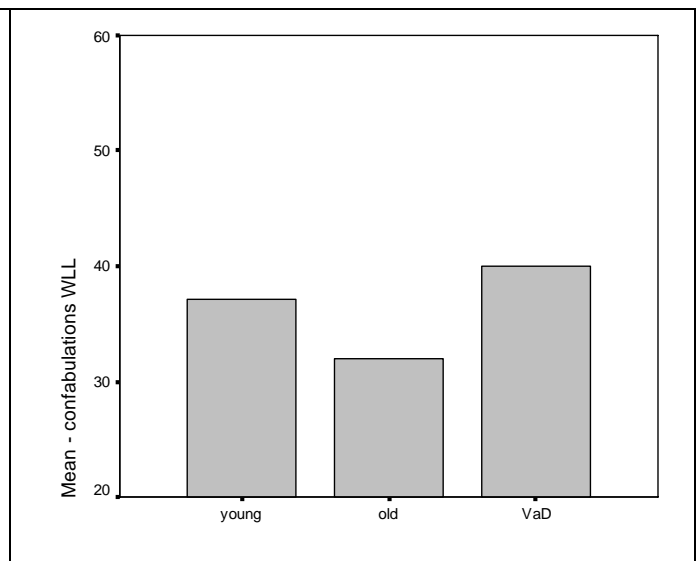
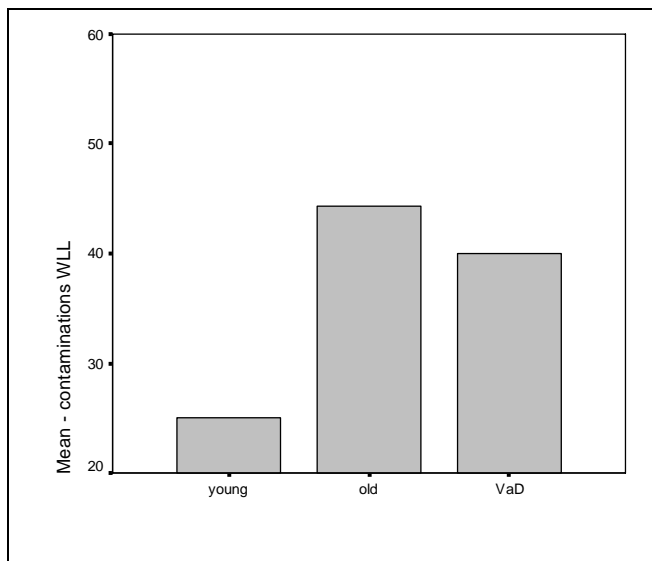

Figure 27. The means of error scores on VPA task for the VaD patients, young and elderly participants

The same four error scores were calculated for the WLL task using the same calculation procedures as for the VPA task. Table 37 reports the means of the four error scores of WLL for the three study groups (Figure 28).

Table 37. The means of error scores of WLL task for the study groups.

		Error scores of WLL task			
Subjects		Contaminations	Confabulations	Perseverations	The overall error score for the WLL
young	Number of participants	4	7	0	9
	Mean	25	37.14		40
	<i>SD</i>	10.000	21.381		20.000
old	Number of participants	14	10	0	19
	Mean	44.29	32.00		49.47
	<i>SD</i>	33.447	19.322		49.607
VaD	Number of patients	5	4	1	8
	Mean	40	40	80	55
	<i>SD</i>	24.495	16.330		60.238



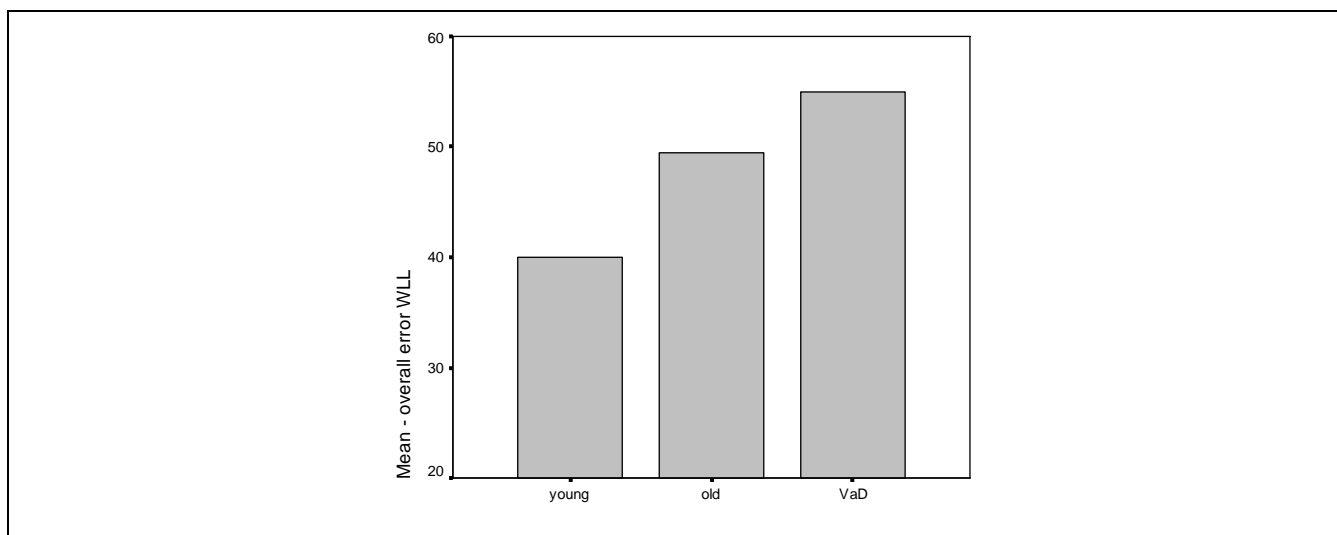

Figure 28. The means of error scores on WLL task for the VaD patients, young and elderly participants

The study participants showed two types of contaminations: within list contaminations – only for the VPA task, when participants did not pair the right words, and between lists contaminations – for the delayed trial of the VPA task and for all trials of the WLL task, when words from VPA intruded in recall of the WLL task and when words from the WLL task intruded in delayed recall of the VPA task. The two error scores were calculated for within and between lists contaminations. They were defined as the number of within/ between contaminations divided by the number of trials in which contaminations were made. Table 38 reports the means of these two error scores for the three study groups (Figure 29).

Table 38. The means of the two contamination error scores for the study groups.

		Error scores for contaminations	
Subjects		The between lists errors	The within list errors
young	Number of part.	4	4
	Mean	100	183.33
	<i>SD</i>	.000	57.735
old	Number of part.	13	14
	Mean	129.17	222.44
	<i>SD</i>	57.060	90.612
VaD	Number of pat.	5	1
	Mean	100	100
	<i>SD</i>	.000	

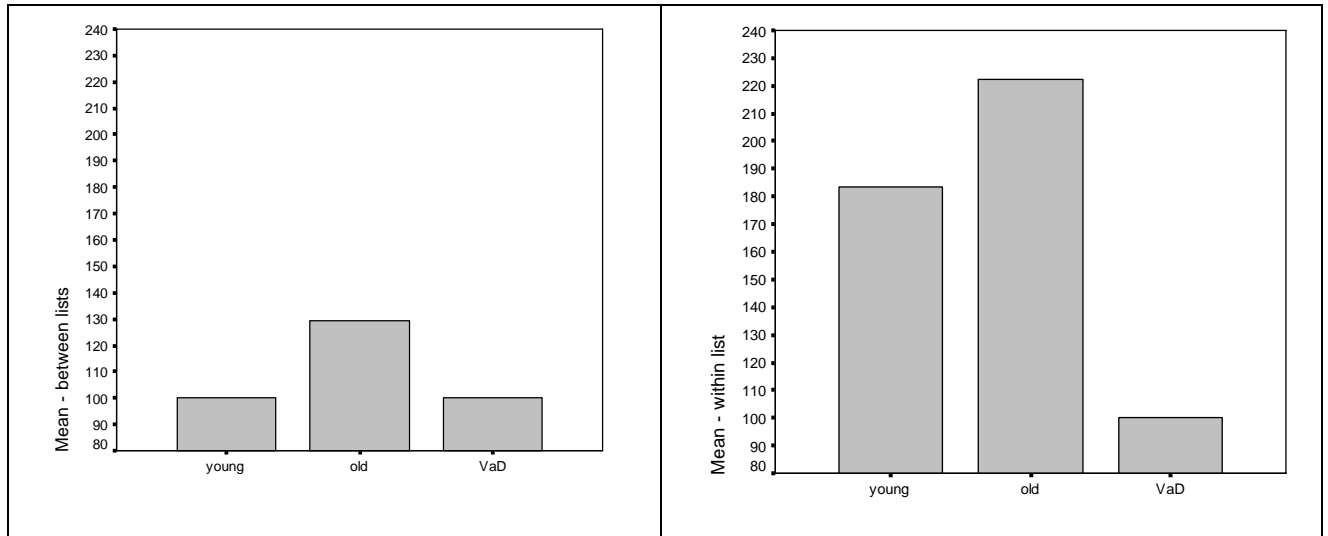

Figure 29. The means of two contamination error scores for VaD patients, young and elderly participants

To determine differences in error scores made by the three study groups the data of all ten error scores were entered into a one-way ANOVA. No statistically significant differences were detected for the three study groups on either of the error scores.

A one-way ANOVA was not performed for the perseveration error score of the WLL task because only one VaD patient had this type of intrusions while no other VaD patients or healthy controls did.

A one-way ANOVA was not performed for the confabulation and perseveration intrusion error scores of the VPA task because confabulations were only detected for one elderly participant and one VaD patient and perseveration errors only for one young and three elderly participants.

13.3.1.2. Performance of the VaD patients and age and education matched healthy elderly participants.

To make clear if VaD patients performed the episodic memory task worse than healthy elderly participants data for these two groups was entered into a statistical analysis. Table 39 reports the means of the learning slopes and the episodic memory scores of the VPA and WLL tasks for the VaD patients and elderly participants (Figure 30).

Table 39. Mean performances on the memory tasks for study groups

Subjects		Learning slope VPA	Learning slope WLL	Episodic memory VPA	Episodic memory WLL
old	Mean	2.5200	4.7600	61.1286	49.7045
	<i>SD</i>	2.084	1.855	40.562	29.519
VaD	Mean	.6154	2.0769	19.2308	5.3846
	<i>SD</i>	1.193	1.754	38.397	14.500

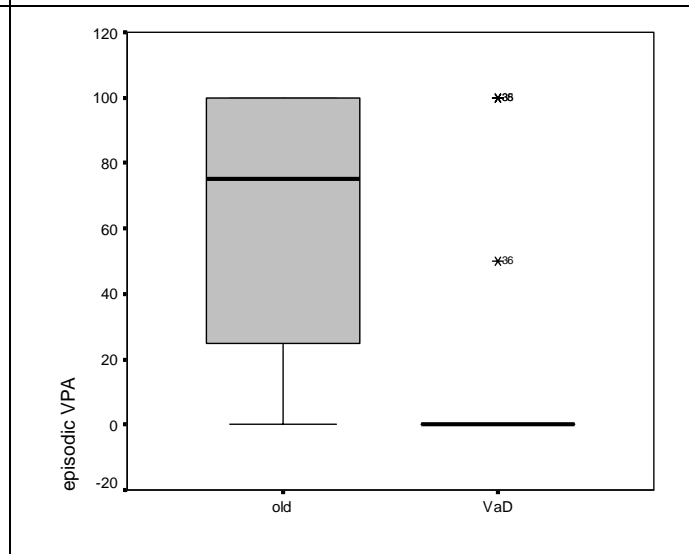
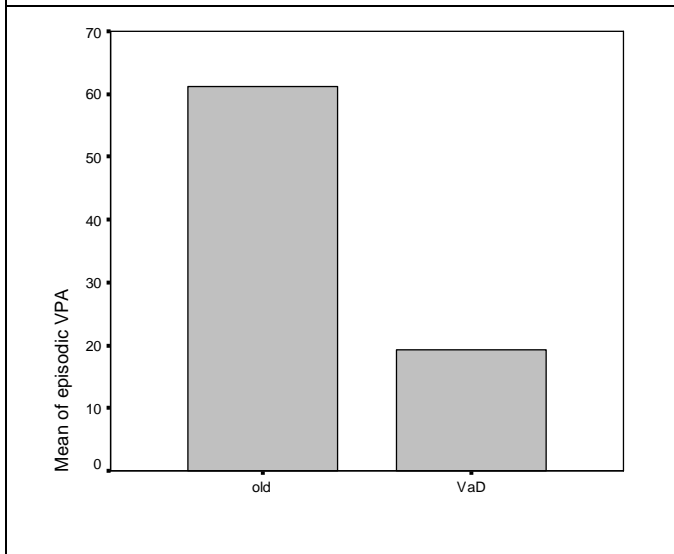
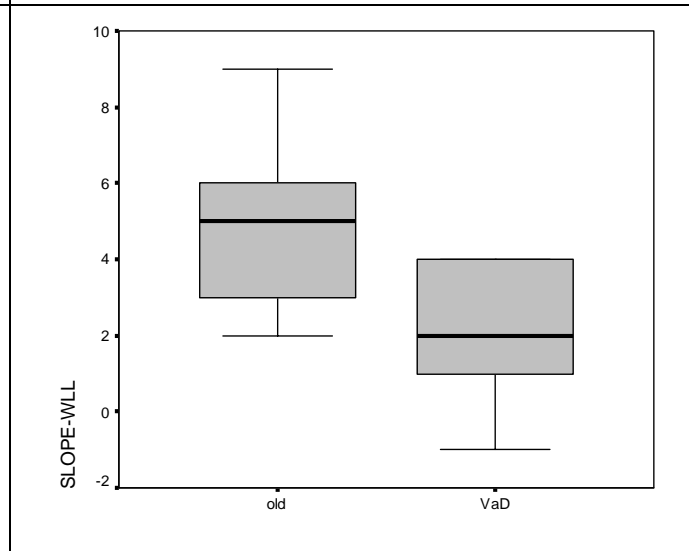
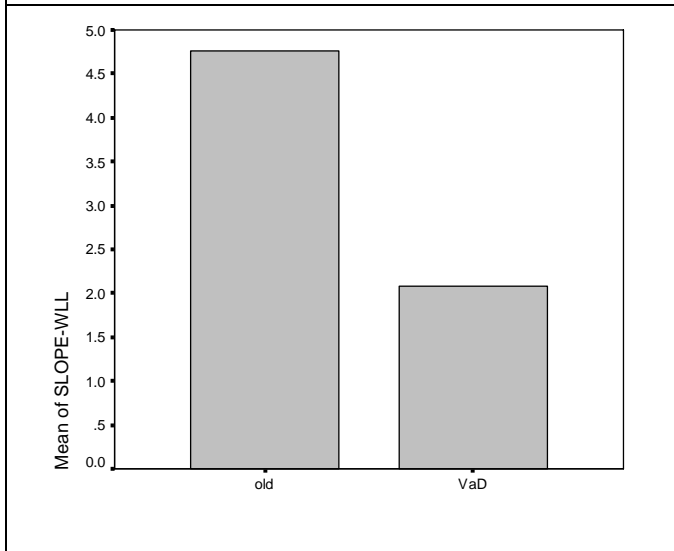
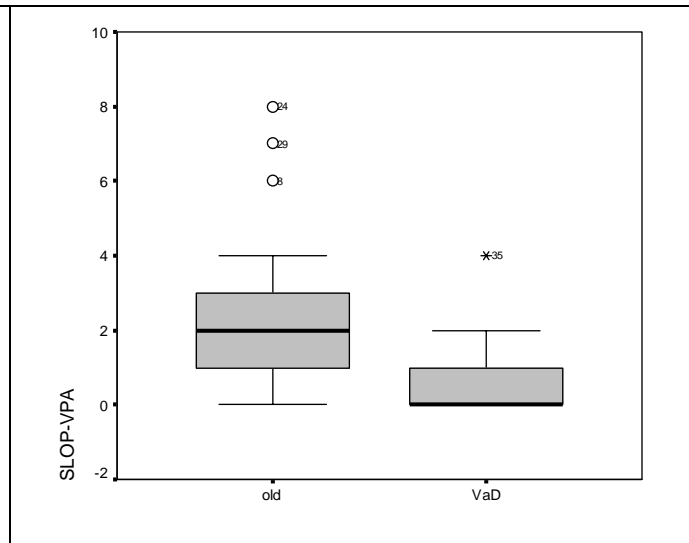
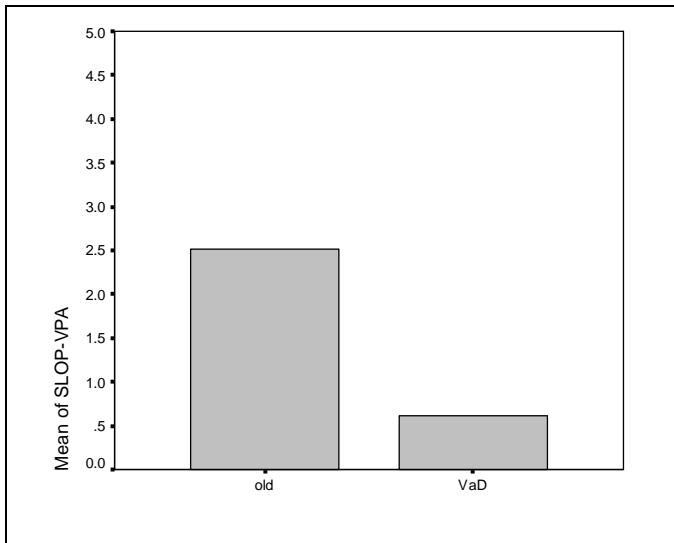

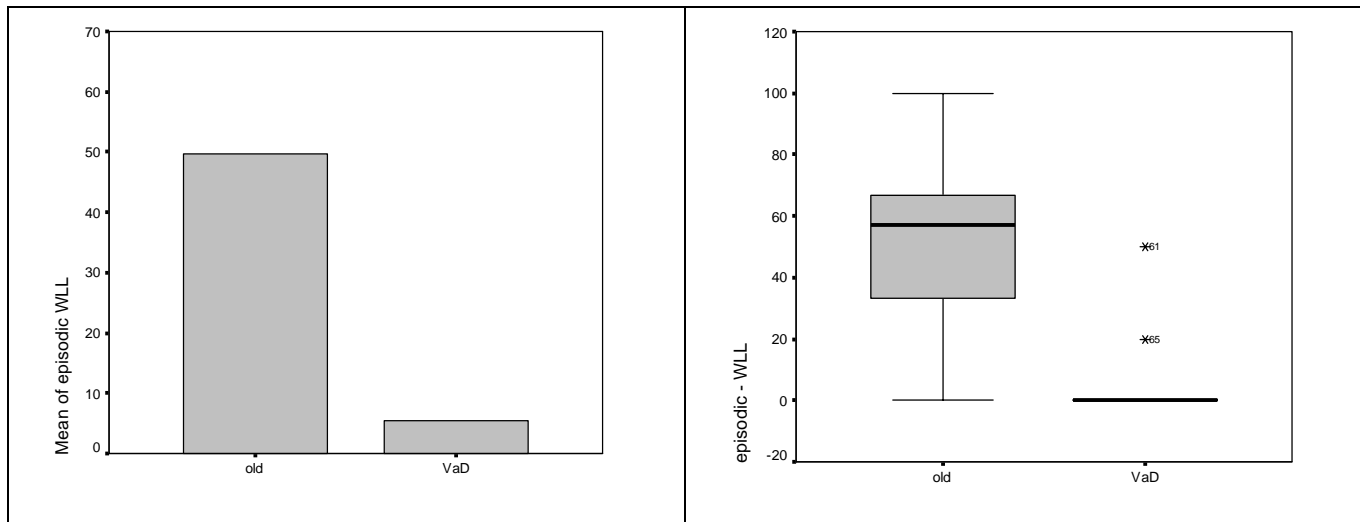

Figure 30. The means of memory scores for the VaD patients and elderly participants.

Statistically significant differences were found on all four scores for the two study groups: for the learning slope of the VPA task $t(35.547)=3.579$, $p<.001$, for the learning slope of the WLL task $t(36)=4.307$, $p<.0001$, for the episodic memory score of the VPA task $t(36)=3.075$, $p<.004$ and for the episodic memory score of the WLL task $t(35.957)=6.204$, $p<.0001$. The performance of the elderly participants on the four memory tasks was significantly superior to the performance of the VaD patients.

The ten error scores were compared for the two study groups. No statistically significant differences were found on the error scores for the two study groups. Only the difference between the means of the between lists contamination errors for the two study groups was significant at one tail $t(13)=1.913$, $p<.078$. The elderly group had slightly more between lists errors.

13.3.1.3. Correlation of dual-task and episodic memory performance.

To determine whether episodic memory performance is correlated with the dual-task performance, correlation coefficients were calculated for the four memory scores, four computerised and paper and pencil *mu* scores separately for the each of three study groups.

Table 40. Correlation of the memory scores and dual task *mu* scores for the young participants.

		Learning slope VPA	Learning slope WLL	Episodic memory VPA	Episodic memory WLL
Computerised (digits recalled correctly) <i>mu</i> score	Pearson Correlation	-.115	.018	-.057	-.262
	Sig. (2-tailed)	.574	.929	.783	.196
	Number of participants	26	26	26	26
Computerised (lists recalled correctly) <i>mu</i> score	Pearson Correlation	-.005	.307	-.067	-.299
	Sig. (2-tailed)	.981	.127	.746	.138
	Number of participants	26	26	26	26

Paper and pencil (digits recalled correctly) <i>mu</i> score	Pearson Correlation	.072	.037	.042	.048
	Sig. (2-tailed)	.727	.857	.840	.815
	Number of participants	26	26	26	26
Paper and pencil (lists recalled correctly) <i>mu</i> score	Pearson Correlation	.005	.022	.078	.096
	Sig. (2-tailed)	.981	.915	.706	.640
	Number of participants	26	26	26	26
Learning slope VPA	Pearson Correlation	1	.281	.088	.055
	Sig. (2-tailed)	.	.165	.670	.790
	Number of participants	26	26	26	26
Learning slope WLL	Pearson Correlation	.281	1	-.134	-.447(*)
	Sig. (2-tailed)	.165	.	.514	.022
	Number of participants	26	26	26	26
Episodic memory VPA	Pearson Correlation	.088	-.134	1	.427(*)
	Sig. (2-tailed)	.670	.514	.	.030
	Number of participants	26	26	26	26
Episodic memory WLL	Pearson Correlation	.055	-.447(*)	.427(*)	1
	Sig. (2-tailed)	.790	.022	.030	.
	Number of participants	26	26	26	26
MMSE	Pearson Correlation	.026	-.292	.046	.336
	Sig. (2-tailed)	.899	.148	.823	.093
	Number of participants	26	26	26	26
WMSPAN	Pearson Correlation	-.183	-.387	.201	.268
	Sig. (2-tailed)	.372	.051	.325	.186
	Number of participants	26	26	26	26
DIGITSPAN	Pearson Correlation	-.301	-.388(*)	.110	-.075
	Sig. (2-tailed)	.135	.050	.594	.717
	Number of participants	26	26	26	26

No statistically significant correlations were detected between the memory and dual-task *mu* scores for the group of young participants (Table 40). A statistically significant positive correlation was detected between the VPA and WLL episodic memory scores $r=.427$, $p<.03$ for the young participants. A significant negative correlation was found between the learning slope and the episodic memory scores of the WLL task $r=-.447$, $p<.022$. A significant negative correlation was

found between the MMSE score and the computerised *mu* score – lists recalled correctly $r=-.415$, $p<.035$ for the young participants.

Table 41. Correlation of memory scores and dual task *mu* scores for the old participants.

		Learning slope VPA	Learning slope WLL	Episodic memory VPA	Episodic memory WLL
Computerised (digits recalled correctly) <i>mu</i> score	Pearson Correlation	.022	-.122	.519(**)	.189
	Sig. (2-tailed)	.918	.560	.008	.367
	Number of participants	25	25	25	25
Computerised (lists recalled correctly) <i>mu</i> score	Pearson Correlation	.092	-.210	.261	.160
	Sig. (2-tailed)	.669	.324	.217	.455
	Number of participants	24	24	24	24
Paper and pencil (digits recalled correctly) <i>mu</i> score	Pearson Correlation	-.029	-.221	.019	-.026
	Sig. (2-tailed)	.892	.299	.931	.905
	Number of participants	24	24	24	24
Paper and pencil (lists recalled correctly) <i>mu</i> score	Pearson Correlation	.002	-.210	.058	.017
	Sig. (2-tailed)	.994	.326	.788	.936
	Number of participants	24	24	24	24
Learning slope VPA	Pearson Correlation	1	.238	.045	.042
	Sig. (2-tailed)	.	.251	.831	.841
	Number of participants	25	25	25	25
Learning slope WLL	Pearson Correlation	.238	1	.119	-.073
	Sig. (2-tailed)	.251	.	.570	.730
	Number of participants	25	25	25	25
Episodic memory VPA	Pearson Correlation	.045	.119	1	.338
	Sig. (2-tailed)	.831	.570	.	.099
	Number of participants	25	25	25	25
Episodic memory WLL	Pearson Correlation	.042	-.073	.338	1
	Sig. (2-tailed)	.841	.730	.099	.
	Number of participants	25	25	25	25
MMSE	Pearson Correlation	.051	-.104	.163	.349
	Sig. (2-tailed)	.815	.630	.447	.095
	Number of participants	24	24	24	24
WMSPAN	Pearson Correlation	-.325	-.191	.114	.274
	Sig. (2-tailed)	.113	.360	.589	.185
	Number of participants	25	25	25	25

DIGITSPAN	Pearson Correlation	-.343	.062	.164	-.080
	Sig. (2-tailed)	.093	.767	.435	.704
	Number of participants	25	25	25	25

The statistically significant positive correlation was detected between the VPA episodic memory score and the computerised *mu* score – digits recalled correctly for the elderly participants $r=.519$, $p<.008$ (Table 41). No statistically significant correlations were found between the memory scores or with the MMSE score.

For the VaD patients statistically significant correlations were found between the WLL task learning slope and the two paper and pencil *mu* scores: $r=.587$, $p<.035$ for the digits recalled correctly and $r=.658$, $p<.014$ for the lists recalled correctly. No statistically significant correlations were found between the memory scores. The MMSE score was significantly correlated with the computerised *mu* score – lists recalled correctly $r=.605$, $p<.028$, the paper and pencil *mu* score – digits recalled correctly $r=.595$, $p<.032$ and paper and pencil *mu* score – lists recalled correctly $r=.659$, $p<.014$. No statistically significant correlations were found between the episodic memory scores and the dual-task *mu* scores (Table 42).

Table 42. Correlation of the memory scores and dual task *mu* scores for the old participants.

		Learning slope VPA	Learning slope WLL	Episodic memory VPA	Episodic memory WLL
Computerised (digits recalled correctly) <i>mu</i> score	Pearson Correlation	.401	.055	.405	-.197
	Sig. (2-tailed)	.175	.858	.170	.518
	Number of participants	13	13	13	13
Computerised (lists recalled correctly) <i>mu</i> score	Pearson Correlation	.497	.214	.469	-.072
	Sig. (2-tailed)	.084	.482	.106	.816
	Number of participants	13	13	13	13
Paper and pencil (digits recalled correctly) <i>mu</i> score	Pearson Correlation	.170	.587(*)	-.070	.072
	Sig. (2-tailed)	.580	.035	.820	.816
	Number of participants	13	13	13	13
Paper and pencil (lists recalled correctly) <i>mu</i> score	Pearson Correlation	.226	.658(*)	.081	.170
	Sig. (2-tailed)	.457	.014	.792	.579
	Number of participants	13	13	13	13
Learning slope VPA	Pearson Correlation	1	.294	.539	-.111
	Sig. (2-tailed)	.	.329	.057	.718
	Number of participants	13	13	13	13

Learning slope WLL	Pearson Correlation	.294	1	.100	.310
	Sig. (2-tailed)	.329	.	.745	.303
	Number of participants	13	13	13	13
Episodic memory VPA	Pearson Correlation	.539	.100	1	-.201
	Sig. (2-tailed)	.057	.745	.	.509
	Number of participants	13	13	13	13
Episodic memory WLL	Pearson Correlation	-.111	.310	-.201	1
	Sig. (2-tailed)	.718	.303	.509	.
	Number of participants	13	13	13	13
MMSE	Pearson Correlation	.496	.769(**)	.429	-.037
	Sig. (2-tailed)	.085	.002	.143	.904
	Number of participants	13	13	13	13
WMSPAN	Pearson Correlation	.298	.645(*)	.237	.279
	Sig. (2-tailed)	.323	.017	.436	.356
	Number of participants	13	13	13	13
DIGITSPAN	Pearson Correlation	.329	.116	-.053	.131
	Sig. (2-tailed)	.272	.707	.864	.670
	Number of participants	13	13	13	13

13.3.2. Dual-task and working memory span.

13.3.2.1. Performance of VaD patients, age and education matched healthy elderly and education matched young participants.

Table 43 reports the means of the WMS scores for the VaD patients, healthy young and elderly participants (Figure 31).

Table 43. Mean performances on the WMS task for study groups

Subjects		WMS
young	Mean	3.1956
	<i>SD</i>	.786
old	Mean	2.5344
	<i>SD</i>	.676
VaD	Mean	1.4615
	<i>SD</i>	.776

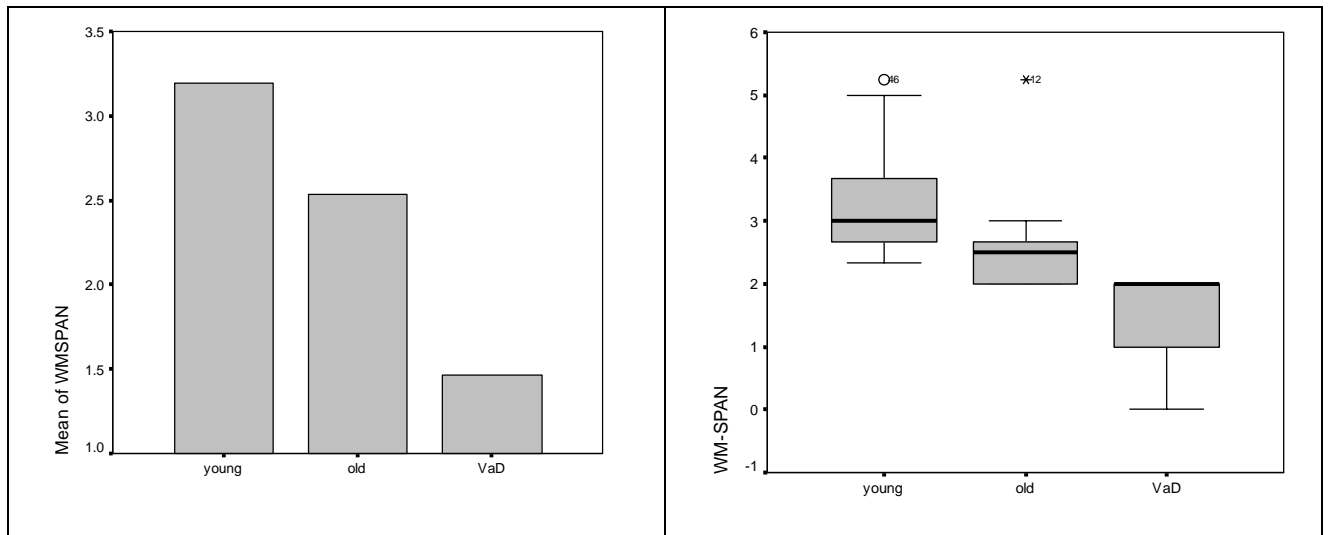

Figure 31. The means of WMS scores for VaD patients, young and elderly participants

To determine differences in the working memory capacity of the three study groups, the data of the WPS scores was entered into a one-way ANOVA. A statistically significant difference was detected on the WMS for the three study groups $F(2,61)=23.741$, $p<.0001$. Post hoc analysis (Bonferroni) showed significant differences between all three groups: the young and elderly participants ($p<.007$), the young participants and VaD patients ($p<.0001$) and the elderly participants and VaD patients ($p<.0001$).

13.3.2.2. Performance of VaD patients and age and education matched healthy elderly participants.

A significant difference was found between the means of the WMS scores for the elderly participants and the VaD patients $t(21.641)=4.221$, $p<.0001$ (Table 44 and Figure 32).

Table 44. The mean performances on the WMS task for study groups

Subjects		WMS
old	Mean	2.5344
	<i>SD</i>	.676
VaD	Mean	1.4615
	<i>SD</i>	.776

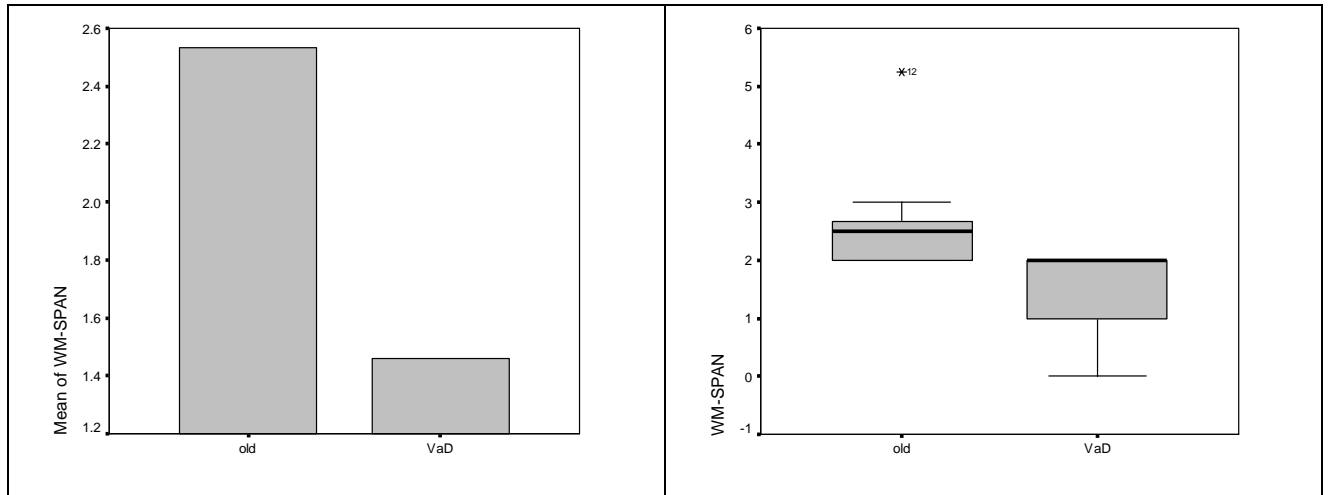

Figure 32. The means of WMS scores for VaD patients and elderly participants.

13.3.2.3. Correlation of the dual-task performance and working memory span.

To determine relationships between working memory capacity and the dual-task performance, WMS, digit span, MMSE scores and the computerised and paper and pencil *mu* scores were entered into the correlation analysis.

No statistically significant correlations were found between the WMS and the dual-task *mu* scores and the MMSE and digit span for the VaD participants, healthy young and elderly participants (Table 45).

Table 45. Correlation of the WMS scores and other study memory scores and dual task *mu* scores for the young, old participants and VaD patients.

		Young participants	Elderly participants	VaD participants
Computerised (digits recalled correctly) <i>mu</i> score	Pearson Correlation	-.192	.247	.261
	Sig. (2-tailed)	.346	.234	.389
	Number of participants	26	25	13
Computerised (lists recalled correctly) <i>mu</i> score	Pearson Correlation	-.235	.086	.480
	Sig. (2-tailed)	.249	.690	.097
	Number of participants	26	24	13
Paper and pencil (digits recalled correctly) <i>mu</i> score	Pearson Correlation	-.038	.198	.354
	Sig. (2-tailed)	.855	.355	.235
	Number of participants	26	24	13
Paper and pencil (lists recalled correctly) <i>mu</i> score	Pearson Correlation	-.108	.102	.472
	Sig. (2-tailed)	.599	.636	.103
	Number of participants	26	24	13

Learning slope VPA	Pearson Correlation	-.183	-.325	.298
	Sig. (2-tailed)	.372	.113	.323
	Number of participants	26	25	13
Learning slope WLL	Pearson Correlation	-.387	-.191	.645(*)
	Sig. (2-tailed)	.051	.360	.017
	Number of participants	26	25	13
Episodic memory VPA	Pearson Correlation	.201	.114	.237
	Sig. (2-tailed)	.325	.589	.436
	Number of participants	26	25	13
Episodic memory WLL	Pearson Correlation	.268	.274	.279
	Sig. (2-tailed)	.186	.185	.356
	Number of participants	26	25	13
MMSE	Pearson Correlation	.329	.017	.738(**)
	Sig. (2-tailed)	.100	.938	.004
	Number of participants	26	24	13
DIGITSPAN	Pearson Correlation	.165	.190	.096
	Sig. (2-tailed)	.422	.363	.755
	Number of participants	26	25	13

13.3.3. Norms of the memory performance.

According to the study aims norms for the episodic memory and WMS were prepared for the Georgian elderly population.

The means and standard deviations were calculated for the learning slopes, episodic memory and WMS scores. The cut-off scores of the normal population for each task were determined as $M \pm 2SD$ (Table 46).

Table 46. The means, standard deviations and $M \pm 2SD$ for the memory scores for the elderly participants.

	Learning slope VPA	Learning slope WLL	Episodic memory VPA	Episodic memory WLL	WMS
Mean	2.984	4.952	67.540	56.108	2.604
SD	2.181	1.782	36.729	27.372	.5772
Mean – 2×SD	-1.378	1.389	-5.919	1.363	1.450
Mean + 2×SD	7.347	8.516	140.998	110.853	3.758

A separate table with norms was prepared using different levels of education for the elderly participants. In Table 47 the memory scores and the appropriate cut-off scores were calculated for three different education levels common to the Georgian elderly population, persons who finished university, persons who finished professional technical school and those who finished high school.

Table 47. The means, standard deviations and $M \pm 2SD$ for the memory scores for the elderly participants with 3 different levels of education.

		Learning slope VPA	Learning slope WLL	Episodic memory VPA	Episodic memory WLL	WMS
Number of participants	University	54	54	54	54	54
	Proftech	7	7	7	7	7
	School	2	2	2	2	2
Mean	University	2.722	4.778	67.432	54.975	2.668
	Proftech	4.000	5.571	65.561	60.043	2.286
	School	6.500	7.500	77.381	72.917	2.000
Std. Deviation	University	2.023	1.633	38.064	29.247	.584
	Proftech	2.646	2.507	33.064	5.126	.393
	School	.707	.707	8.418	14.731	.000
Mean – 2×SD	University	-1.323	1.512	-8.696	-3.519	1.500
	Proftech	-1.292	.5571	-10.566	49.791	1.499
	School	5.086	6.086	60.545	43.454	2
Mean + 2×SD	University	6.768	8.044	143.559	113.470	3.836
	Proftech	9.292	10.586	131.689	70.295	3.073
	School	7.914	8.914	94.217	102.379	2

In Table 48 the memory scores and appropriate cut-off scores were calculated for the two levels of education: the persons who completed university are labelled as ‘high level of education’ and those who completed professional technical school and high school are together labelled as ‘low level of education’.

Table 48. The means, standard deviations and $M \pm 2SD$ for the memory scores for the elderly participants with 2 different levels of education.

		Learning slope VPA	Learning slope WLL	Episodic memory VPA	Episodic memory WLL	WMS
Number of participants	High education	54	54	54	54	54
	Low education	9	9	9	9	9
Mean	High education	2.722	4.778	67.432	54.975	2.668
	Low education	4.556	6.000	68.188	62.904	2.222
Std. Deviation	High education	2.023	1.633	38.064	29.247	.584
	Low education	2.555	2.345	29.256	8.891	.363
Mean – 2×SD	High education	-1.323	1.512	-8.696	-3.519	1.500
	Low education	-.554	1.310	9.675	45.121	1.496
Mean + 2×SD	High education	6.768	8.044	143.559	113.470	3.836
	Low education	9.666	10.690	126.700	80.687	2.949

A table with norms was prepared for different age intervals. The two age intervals were determined as 50-60 years and 61 and above. In Table 49 the memory scores and appropriate cut-off scores are calculated for these two intervals.

Table 49. The means, standard deviations and $M \pm 2SD$ for the memory scores for the elderly participants with 2 different age intervals.

		Learning slope VPA	Learning slope WLL	Episodic memory VPA	Episodic memory WLL	WMS
Number of participants	50-60	35	35	35	35	35
	61-high	28	28	28	28	28
Mean	50-60	3.686	5.286	81.238	68.084	2.672
	61-high	2.107	4.536	50.417	41.138	2.519
Std. Deviation	50-60	2.246	1.708	26.567	19.209	.509
	61-high	1.771	1.815	40.764	28.940	.652
Mean – 2×SD	50-60	-.807	1.870	28.104	29.666	1.654
	61-high	-1.435	.905	-31.111	-16.743	1.215
Mean + 2×SD	50-60	8.178	8.701	134.372	106.502	3.690
	61-high	5.649	8.166	131.944	99.018	3.823

The five memory scores were calculated for each of the thirteen VaD patients to assess their individual performances on memory tasks (Table 50). The memory score of the VaD patients were compared to the norms of the corresponding memory tasks – the means and intervals with $M \pm 2SD$ boundaries that were defined using data of the 64 healthy elderly participants (Figures 33-37). The VaD patients were divided into two groups according to dementia severity levels determined by the MMSE scores. The group of mild VaD patients consisted of patients with MMSE scores higher than 20 and moderate VaD patients consisted of patients with MMSE scores less than 20. Individual performances on memory scores and dual-task *mu* scores were compared on Figures 38-57.

Table 50. The memory tasks' scores for the 13 VaD patients (sign * indicates those VaD patients who fell outside the normative interval for the variable in the column).

Patient ID	Learning slope VPA	Learning slope WLL	Episodic memory VPA	Episodic memory WLL	WMS	MMSE severity
33	0	-1*	0	0*	0*	moderate
39	0	1*	0	0*	2	moderate
48	0	4	0	0*	2	mild
53	0	0*	0	0*	0*	moderate
64	2	3	0	0*	2	mild
66	4	3	100	0*	2	mild
67	1	4	50	0*	1*	mild
70	0	1*	100	0*	2	mild
74	0	0*	0	0*	1*	moderate
92	0	2	0	0*	1*	moderate
138	0	4	0	50	2	moderate
147	0	4	0	0*	2	mild
148	1	2	0	20	2	mild

It was found that for the learning slope of the VPA task all patients fell in the normative interval. For the learning slope of the WLL 5 patients (38.46% of all VaD patients) from which one mild VaD and the four moderate VaD patients fell outside the normative interval. For the episodic memory score of the VPA task all VaD patients fell within the normative interval. For the episodic memory score of the WLL task 11 VaD patients (84.62% of all VaD patients) fell outside the normative interval of which six were mild VaD and five moderate VaD patients. For the WMS task 5 VaD patients (38.46% of all VaD patients) fell outside the normative interval of which four were moderate and one was mild VaD patients.

Despite the fact that VaD patients' memory scores fell within normative boundaries for some of the memory tasks, the frequency of zero performance in VaD patients was significantly higher than in the healthy elderly participants (Table 51). To compare of the frequency distributions of zero performance on memory scores for the VaD patients and healthy elderly participants, new memory scores corresponding to the existing ones were created. The new memory variables had two scores: 0 – for the old memory score 0 and 1 – for the all other values of the old memory scores

that were different from zero. These new five variables were compared for the VaD patients and healthy elderly participants.

Table 51. The frequencies of the zero scores for the VaD patients and the healthy elderly participants.

The memory task	Healthy elderly	VaD patients	
Learning slope VPA	14.3%	69.23%	
Learning slope WLL	0%	15.38%	
Episodic memory VPA	15.6%	76.92%	Mild – 30.77 %
			Moderate – 46.15%
Episodic memory WLL	9.5%	84.62%	Mild – 46.15%
			Moderate – 38.46%
WMS	0%	15.38%	

Statistically significant differences were found on all five memory scores for the two study groups: for the learning slope of the VPA task $\chi^2 = 18.36$, $df=1$ $p<.0001$, for the learning slope of the WLL task $\chi^2 = 10.109$, $df=1$ $p<.001$, for the episodic memory score of the VPA task $\chi^2 = 21.116$, $df=1$ $p<.0001$, for the episodic memory score of the WLL task $\chi^2 = 35.556$, $df=1$ $p<.001$ and for the WMS task $\chi^2 = 10.109$, $df=1$ $p<.001$.

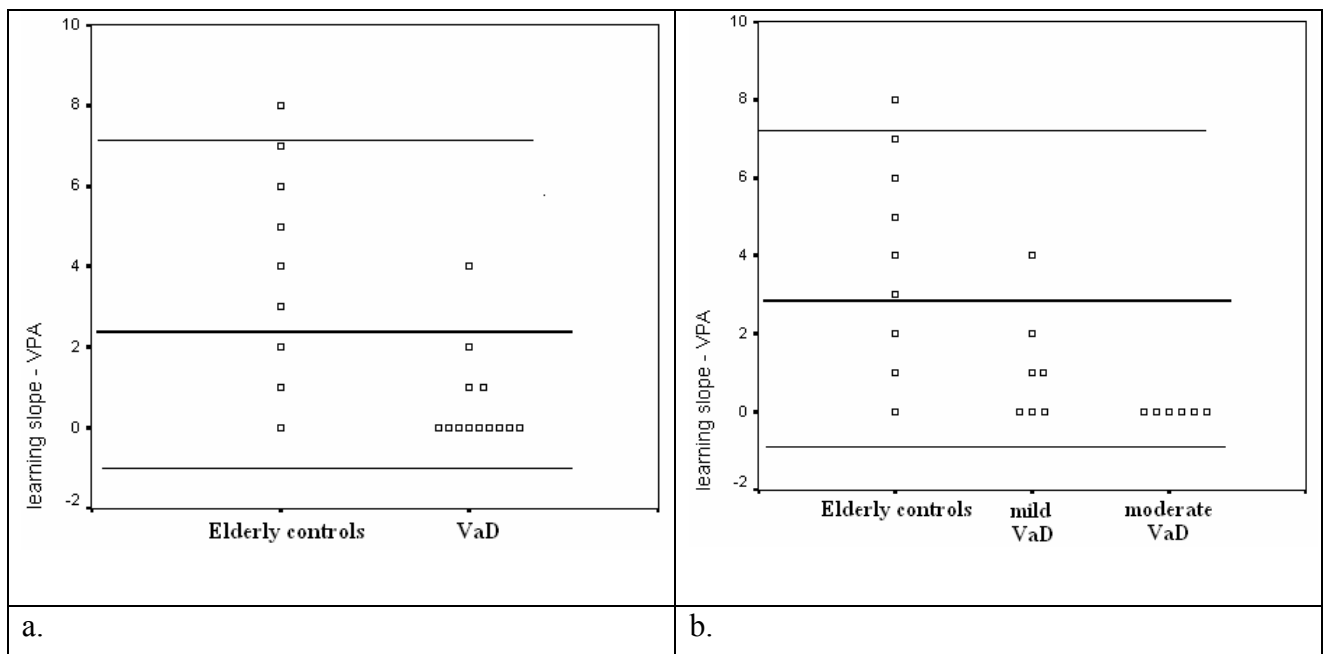

Figure 33. The individual Learning slope scores on the VPA task for a. the elderly participants and VaD patients, b. the elderly participants and the mild and moderate VaD patients.

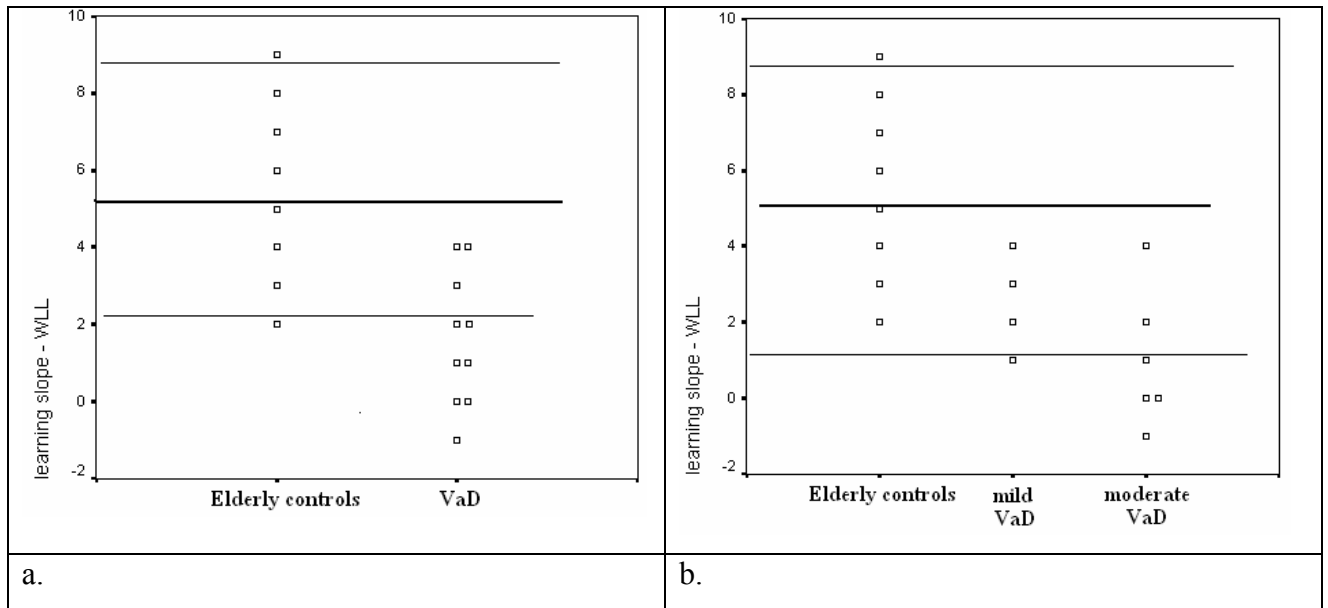

Figure 34. The individual Learning slope scores on the WLL task for a. the elderly participants and VaD patients, b. the elderly participants and the mild and moderate VaD patients.

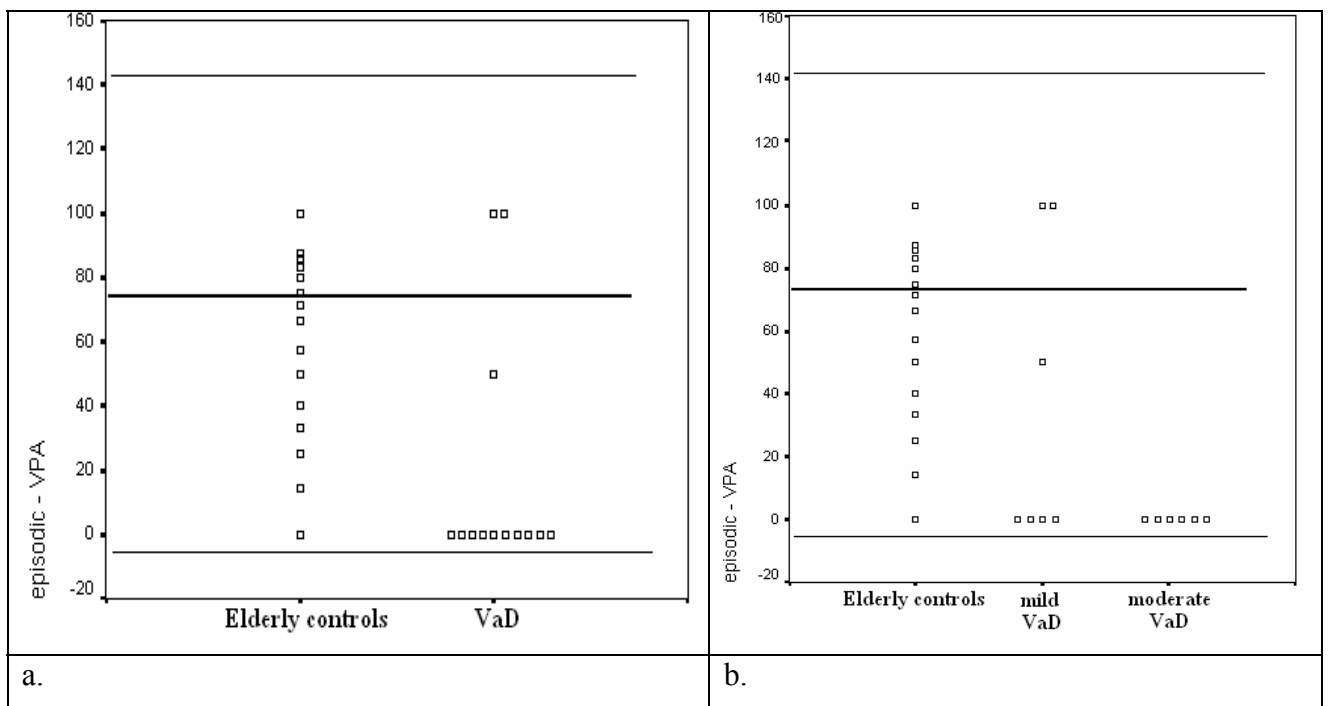

Figure 35. The individual episodic memory scores on the VPA task for a. the elderly participants and VaD patients, b. the elderly participants and the mild and moderate VaD patients.

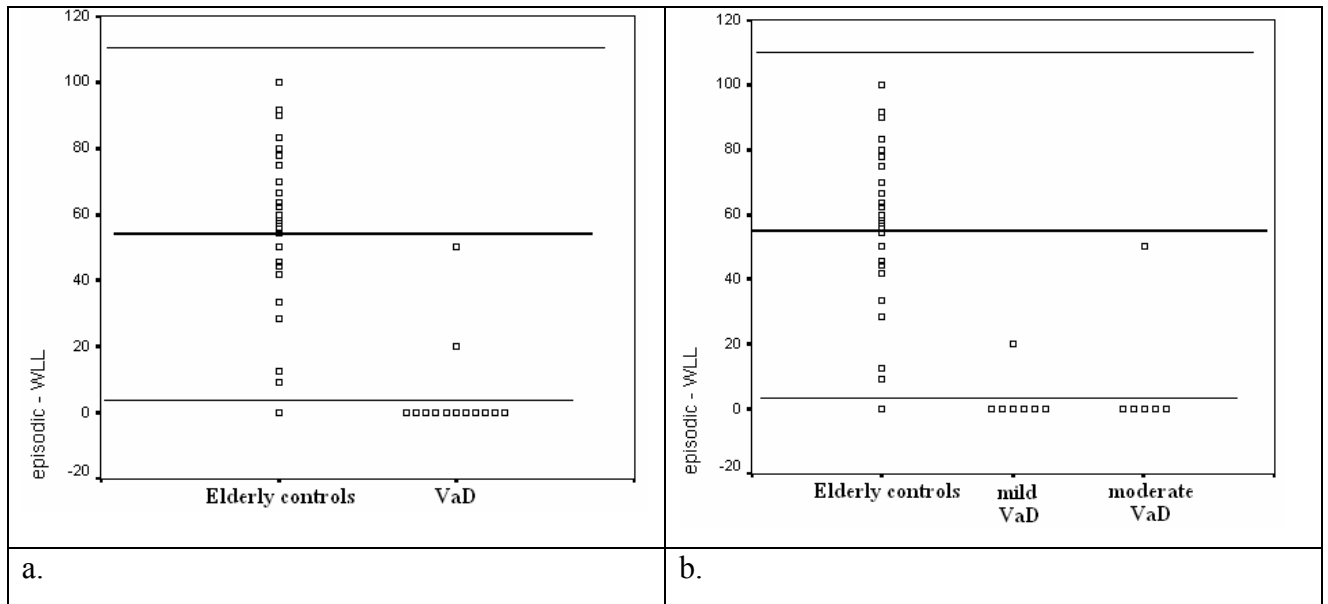

Figure 36. The individual episodic memory scores on the WLL task for a. the elderly participants and VaD patients, b. the elderly participants and the mild and moderate VaD patients.

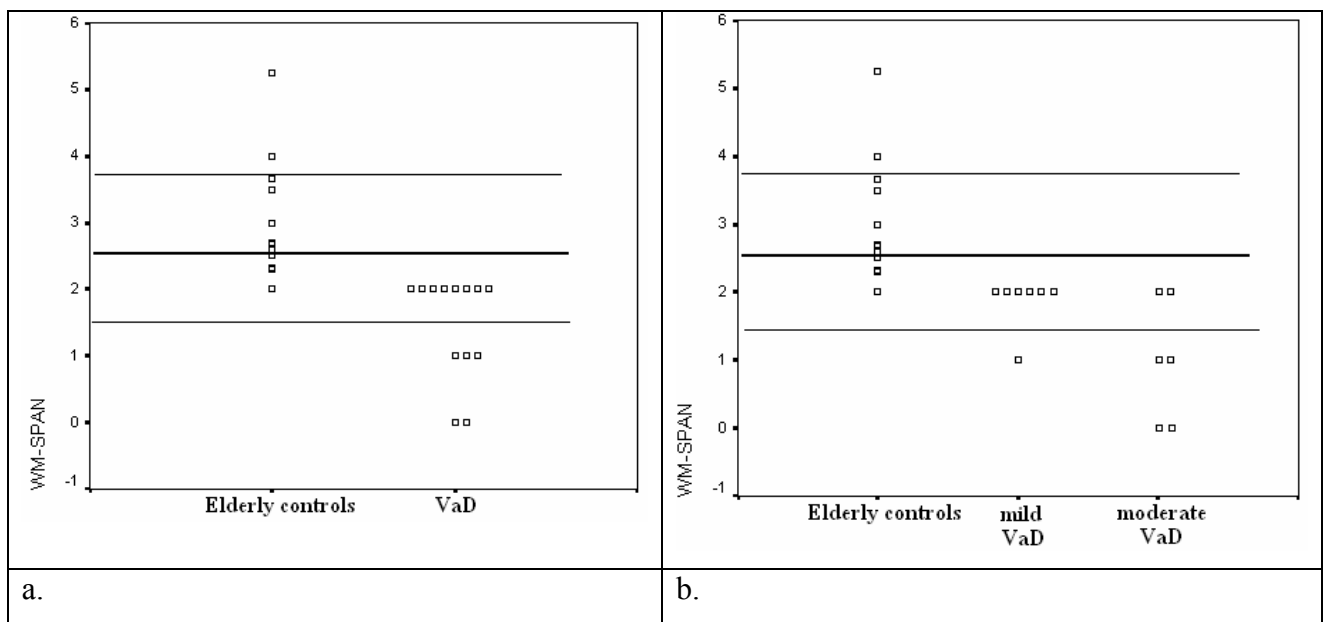

Figure 37. The individual WMS task scores for a. the elderly participants and VaD patients, b. the elderly participants and the mild and moderate VaD patients.

The comparison of the individual performances on the computerised dual-task using *mu* scores – digits recalled correctly and the scores on the memory tasks.

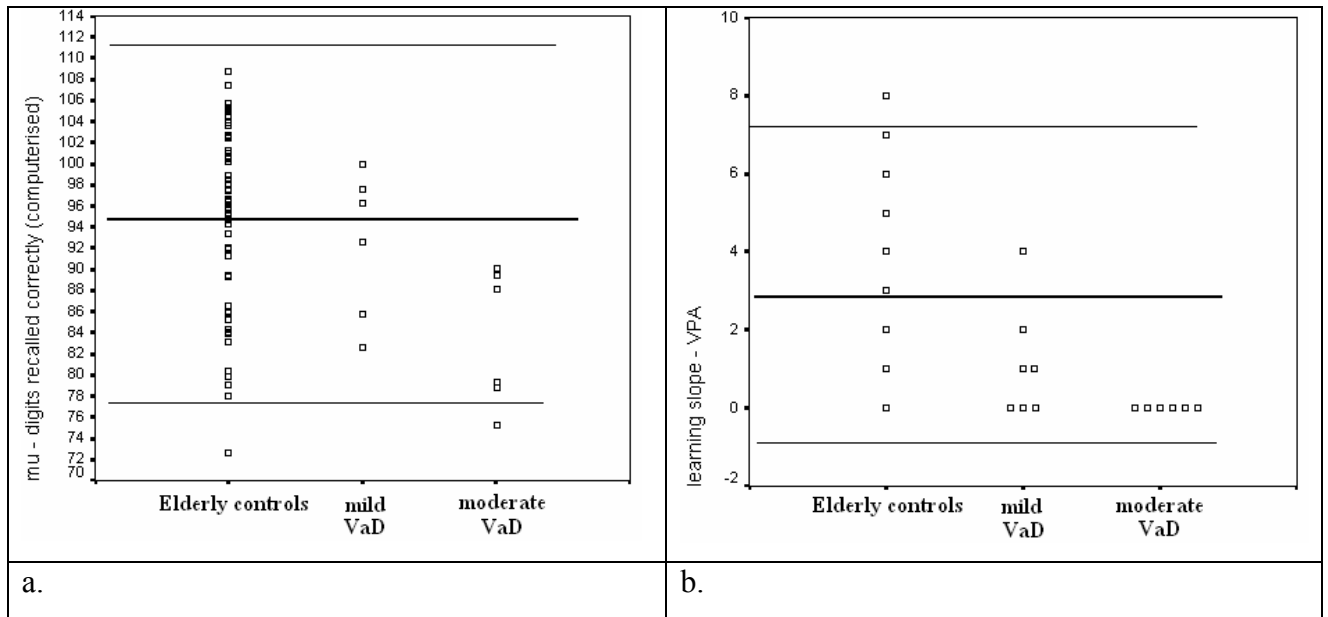

Figure 38. The individual performances on the computerised *mu* scores – digits recalled correctly and the learning slope scores on the VPA task.

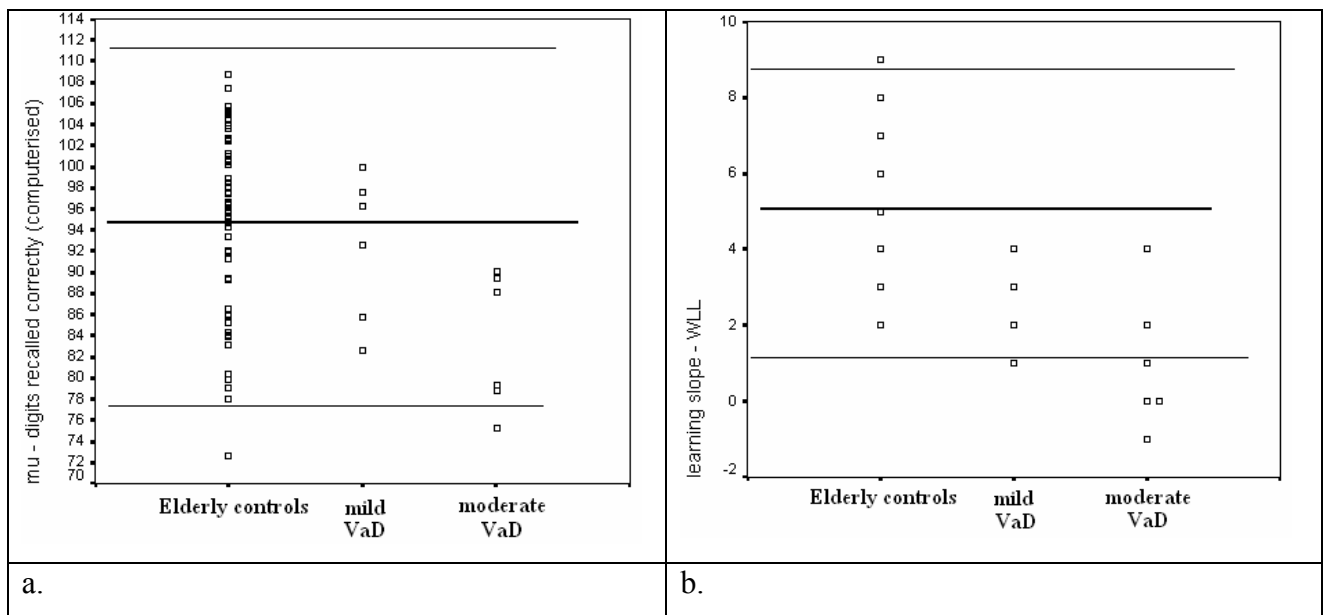

Figure 39. The individual performances on the computerised *mu* scores – digits recalled correctly and the learning slope scores on the WLL task.

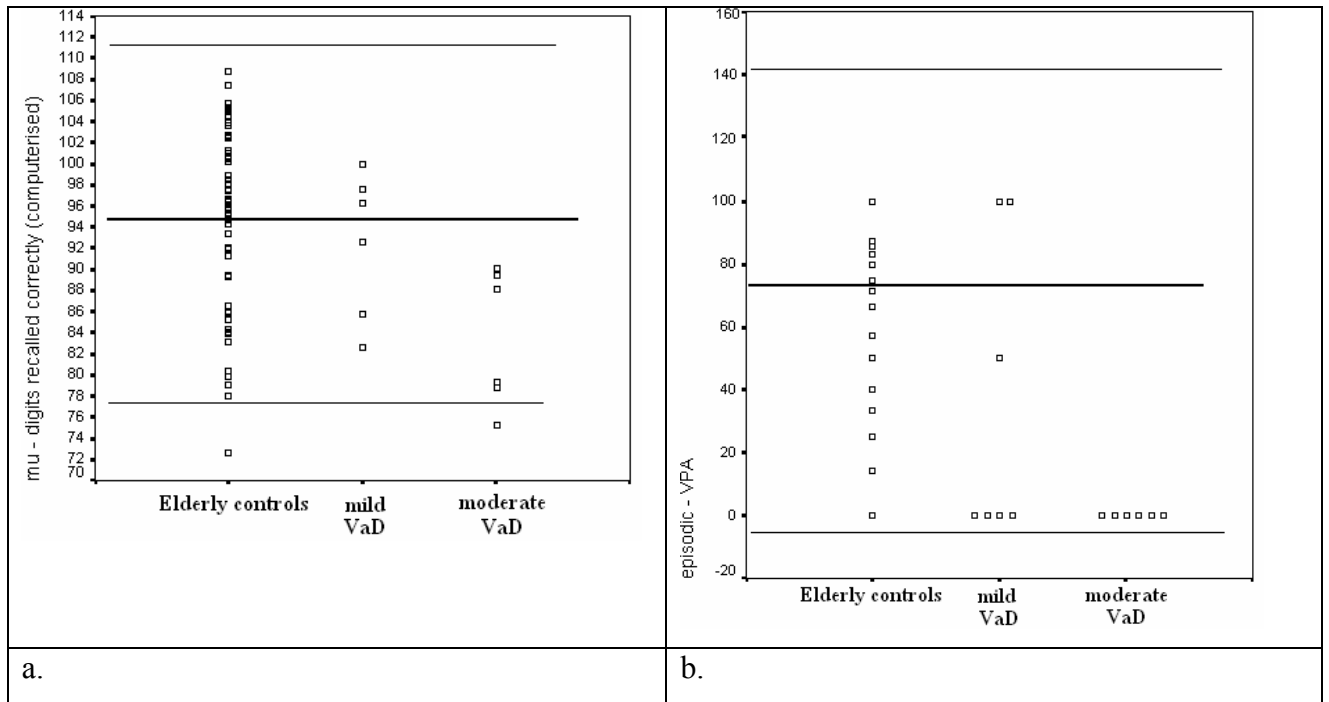

Figure 40. The individual performances on the computerised *mu* scores – digits recalled correctly and the episodic memory scores on the VPA task.

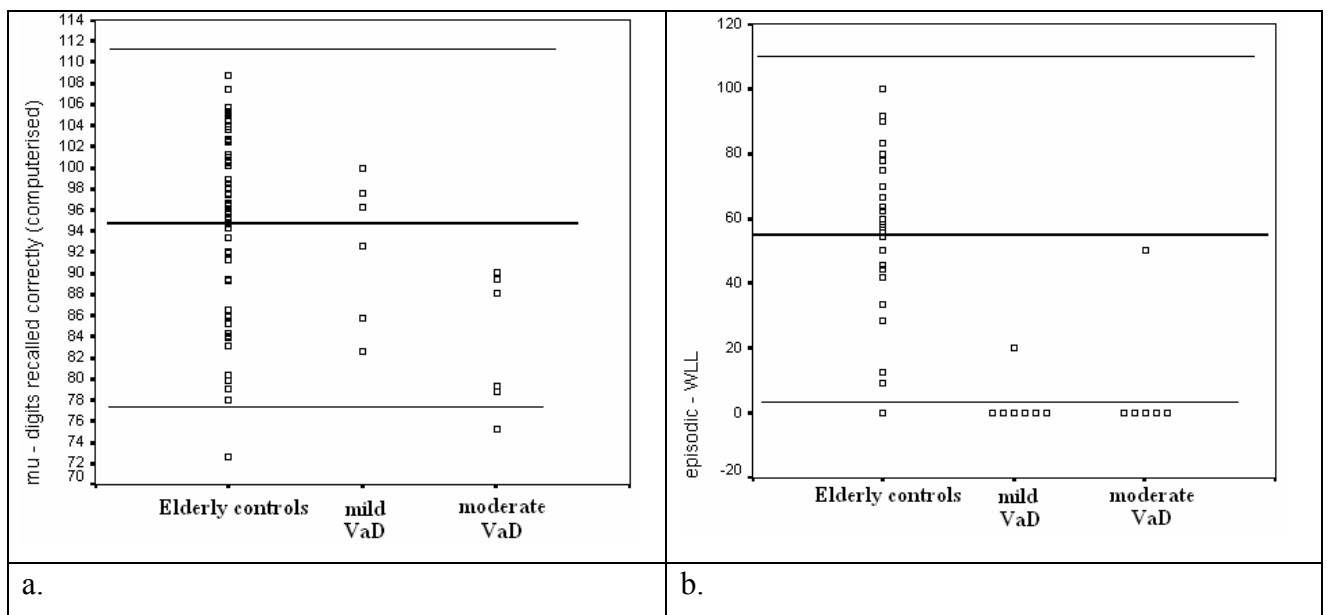

Figure 41. The individual performances on the computerised *mu* scores – digits recalled correctly and the episodic memory scores on the WLL task.

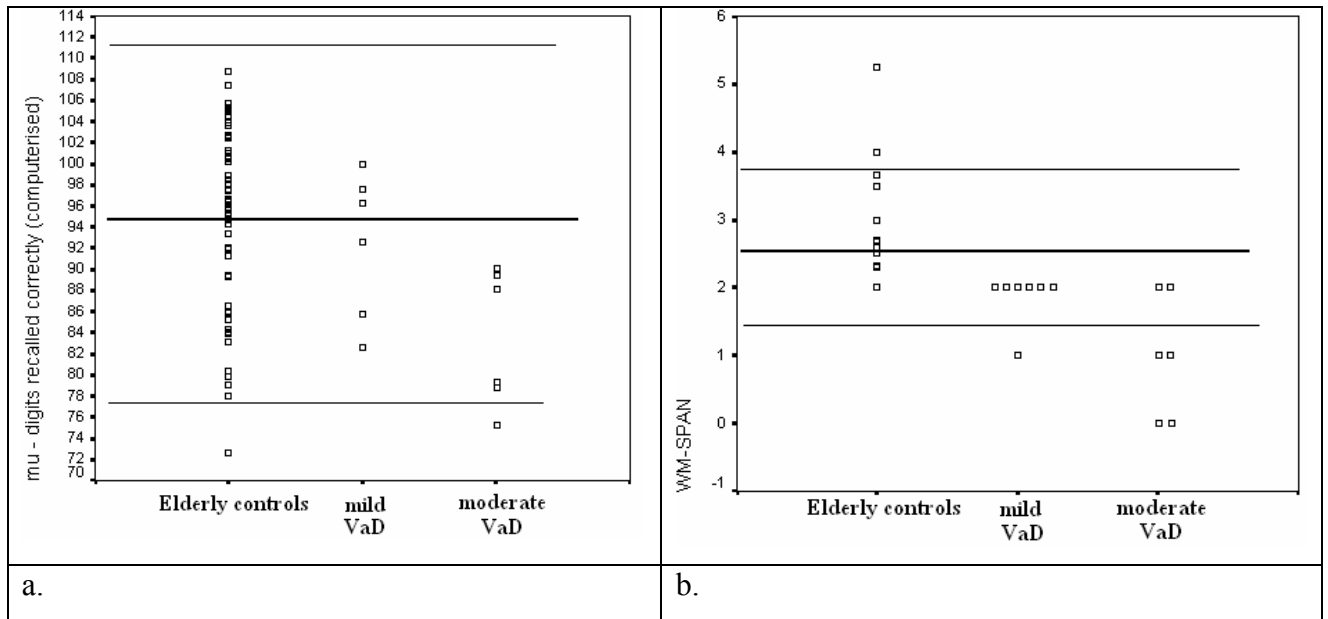

Figure 42. The individual performances on the computerised *mu* scores – digits recalled correctly and the scores on the WMS task.

The comparison of the individual performances on the computerised *mu* scores – lists recalled correctly and the scores on the memory tasks.

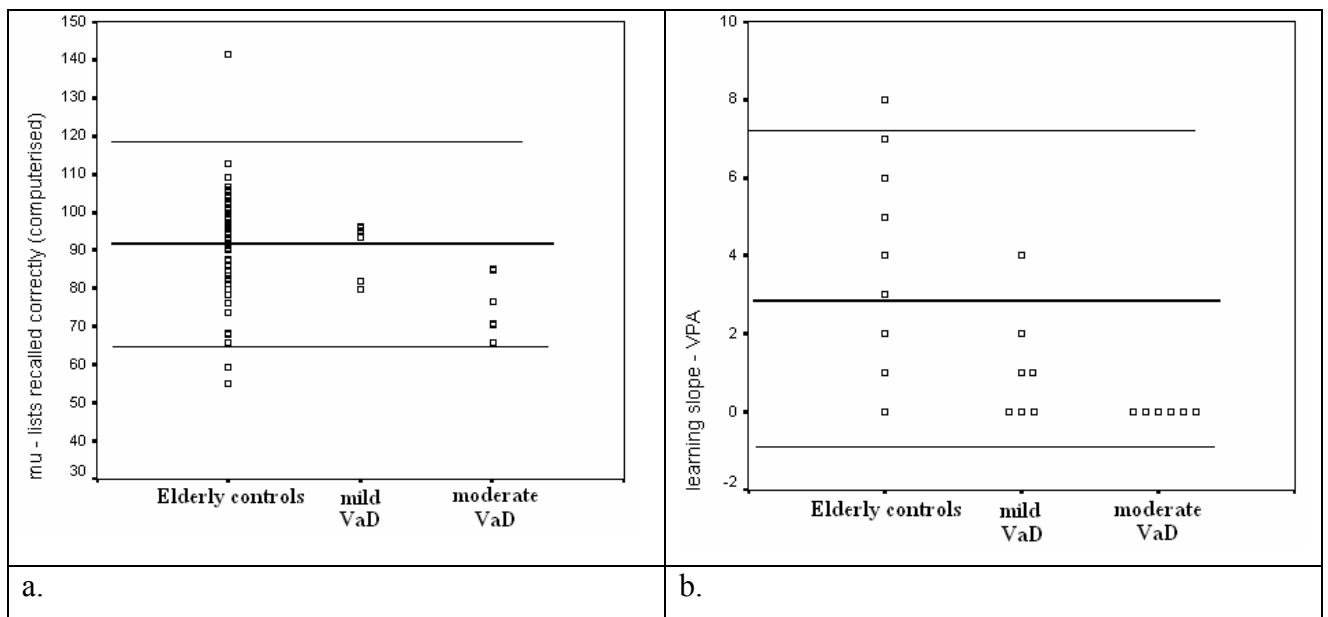

Figure 43. The individual performances on the computerised *mu* scores – lists recalled correctly and the learning slope scores on the VPA task.

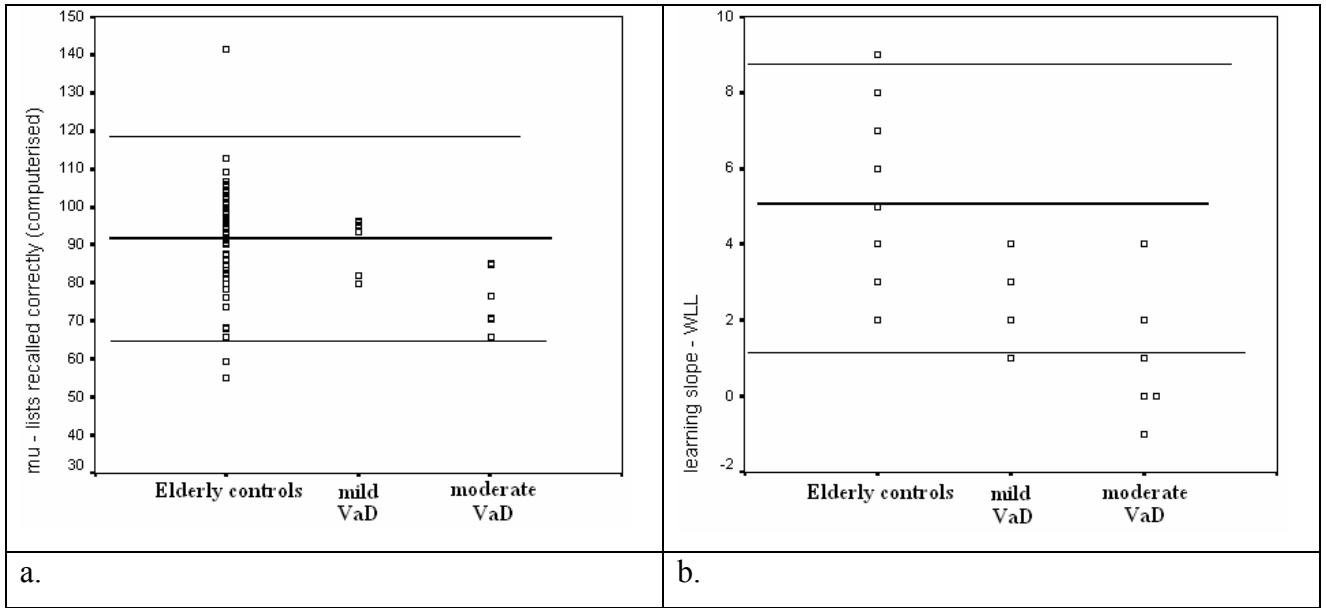

Figure 44. The individual performances on the computerised *mu* scores – lists recalled correctly and the learning slope scores on the WLL task.

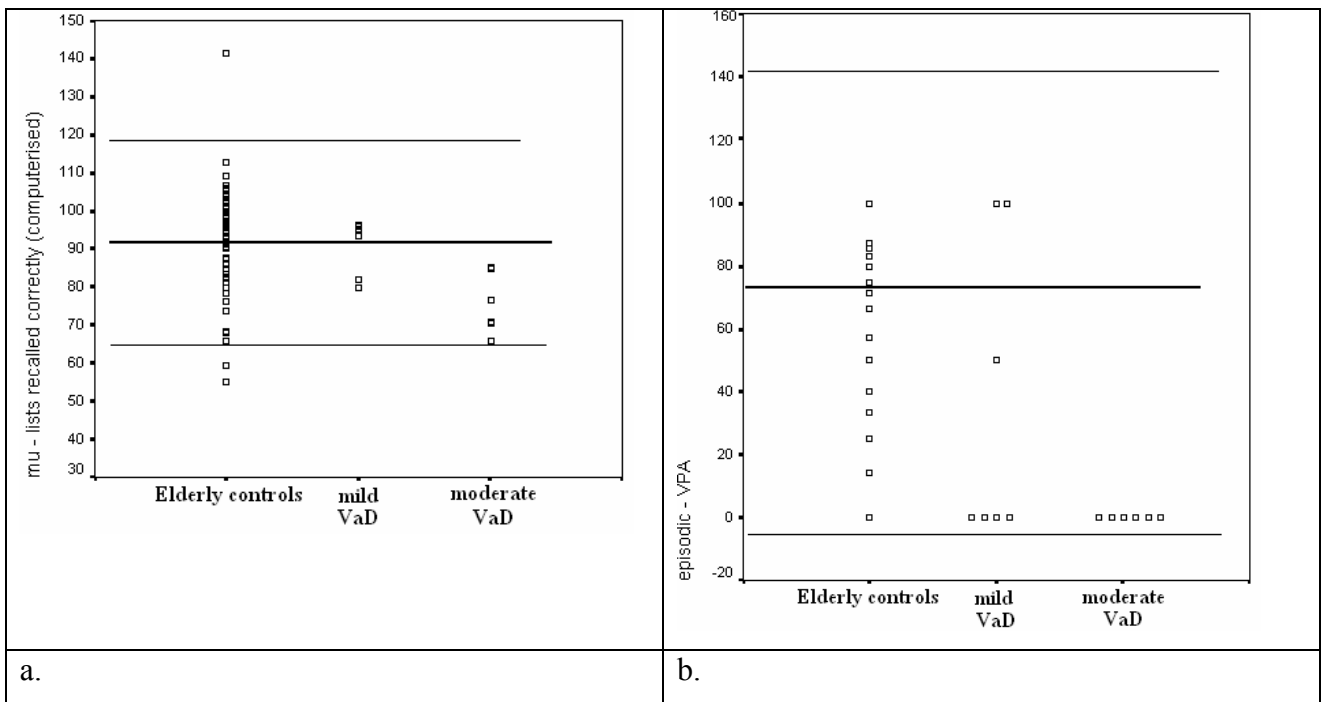

Figure 45. The individual performances on the computerised *mu* scores – lists recalled correctly and the episodic memory scores on the VPA task.

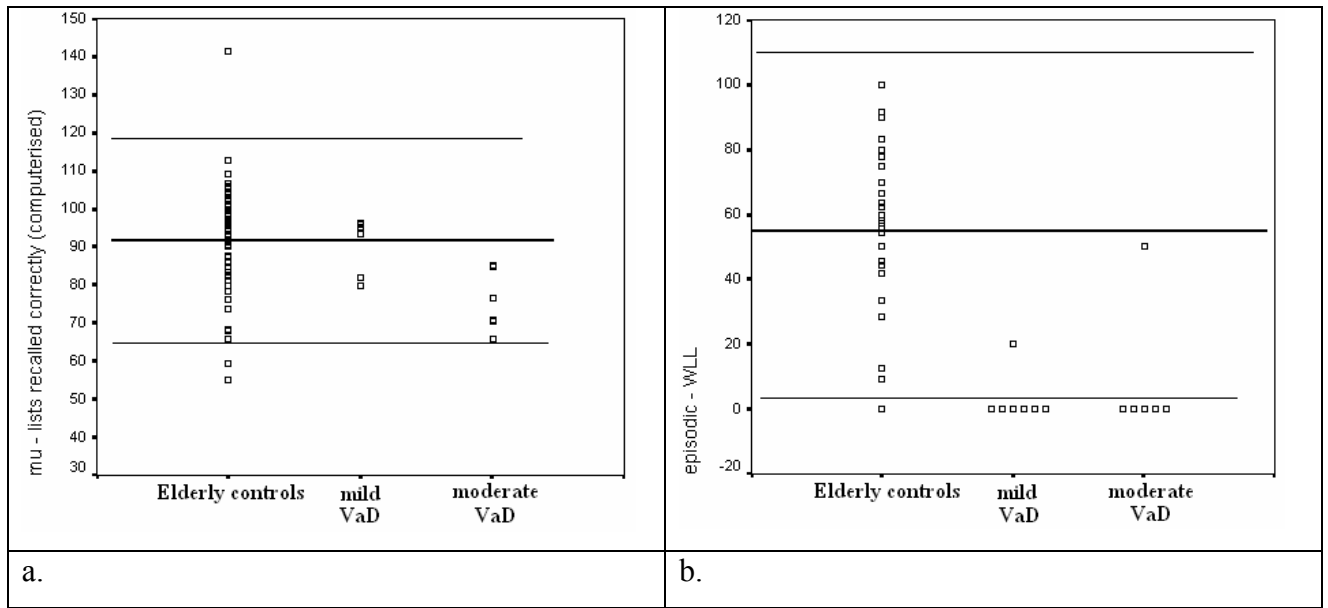

Figure 46. The individual performances on the computerised *mu* scores – lists recalled correctly and the episodic memory scores on the WLL task.

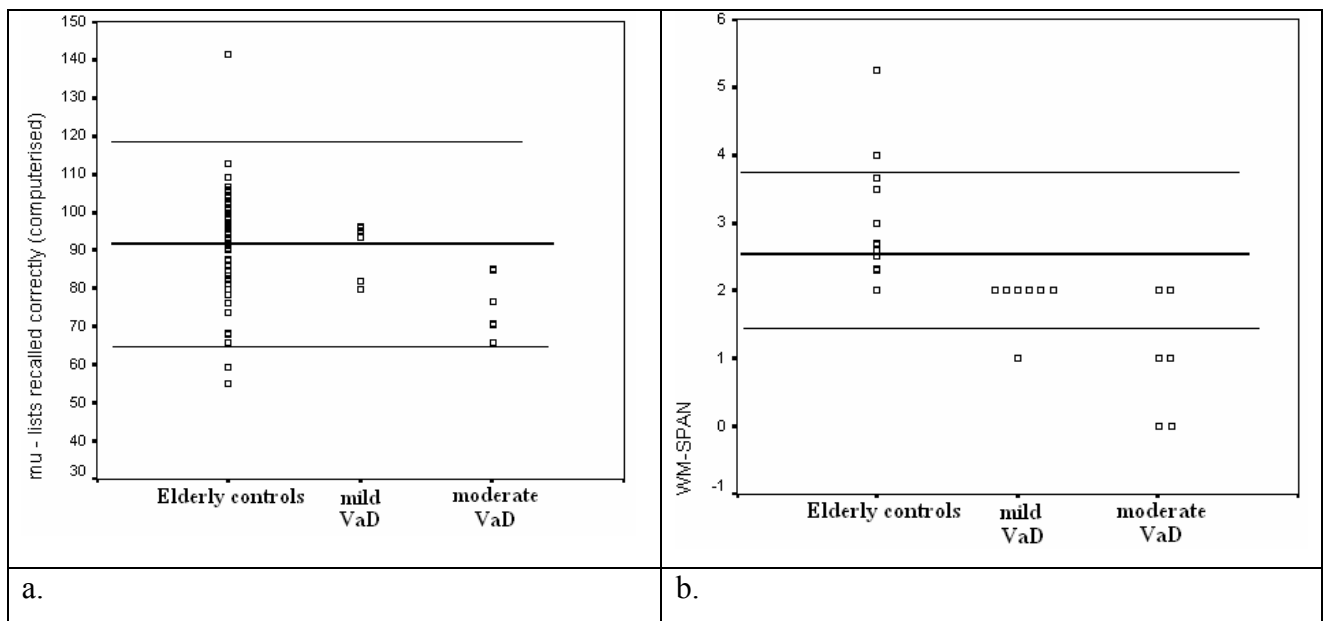

Figure 47. The individual performances on the computerised *mu* scores – lists recalled correctly and the scores on the WMS task.

The comparison of the individual performances on the paper and pencil *mu* scores – digits recalled correctly and the scores on the memory tasks.

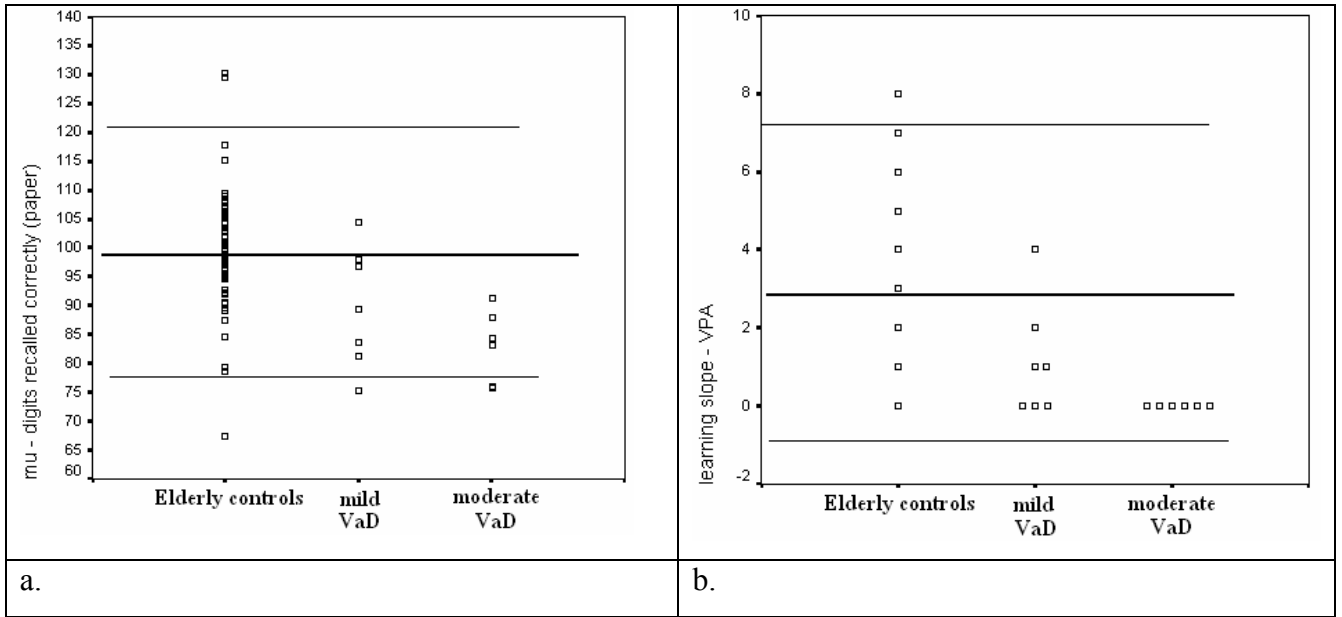

Figure 48. The individual performances on the paper and pencil *mu* scores – digits recalled correctly and the learning slope scores on the VPA task.

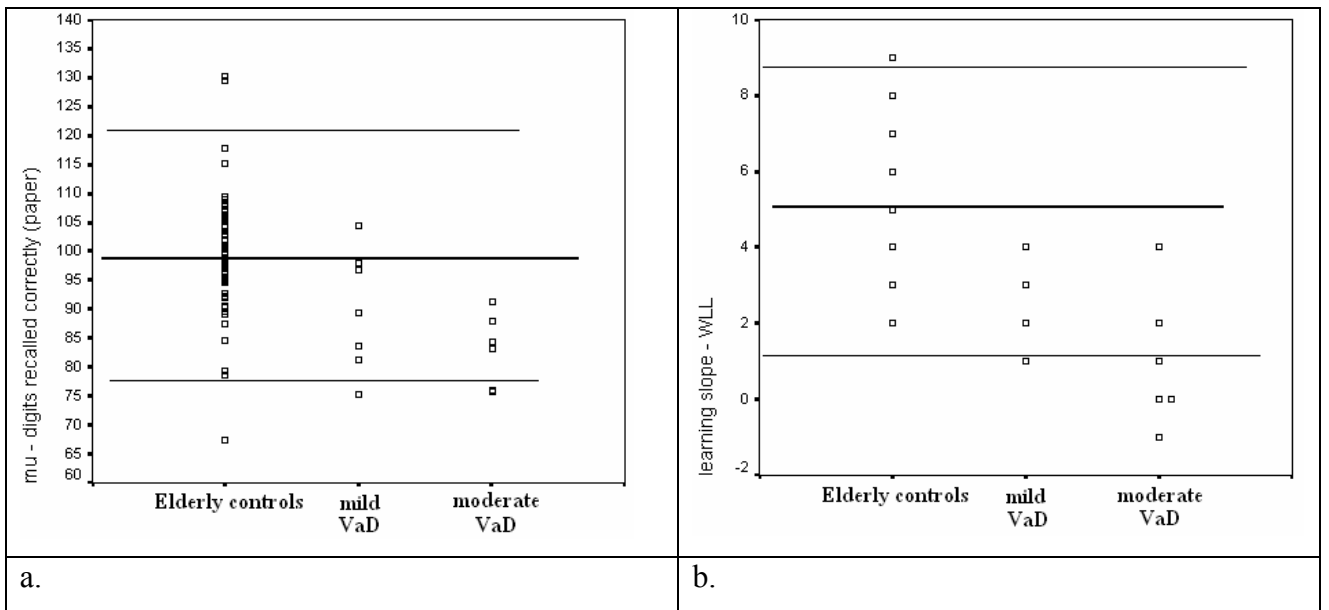

Figure 49. The individual performances on the paper and pencil *mu* scores – digits recalled correctly and the learning slope scores on the WLL task.

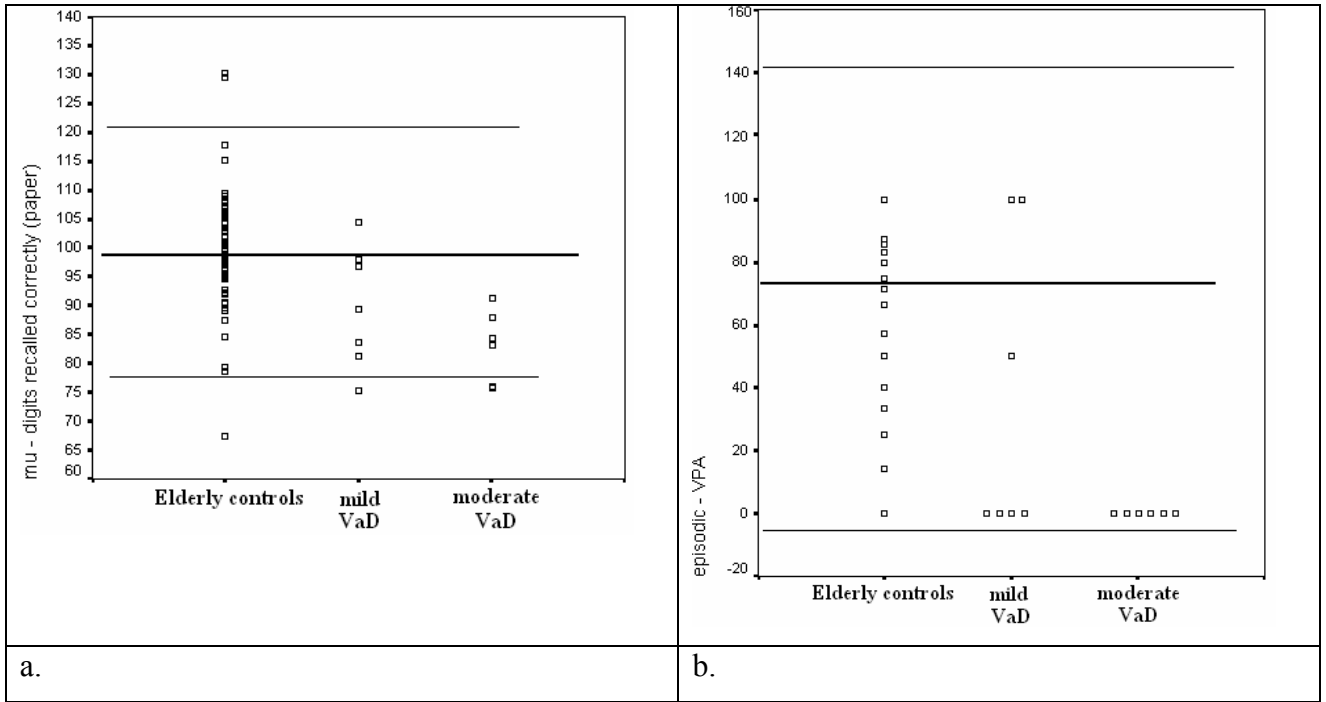

Figure 50. The individual performances on the paper and pencil *mu* scores – digits recalled correctly and the episodic memory scores on the VPA task.

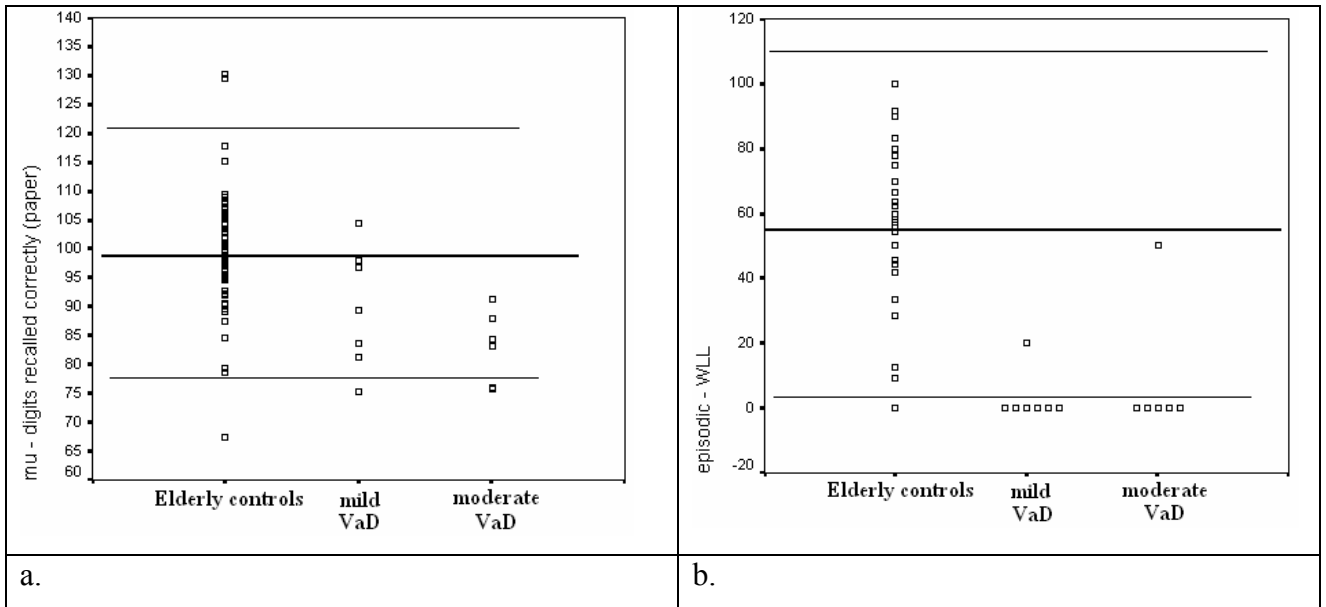

Figure 51. The individual performances on the paper and pencil *mu* scores – digits recalled correctly and the episodic memory scores on the WLL task.

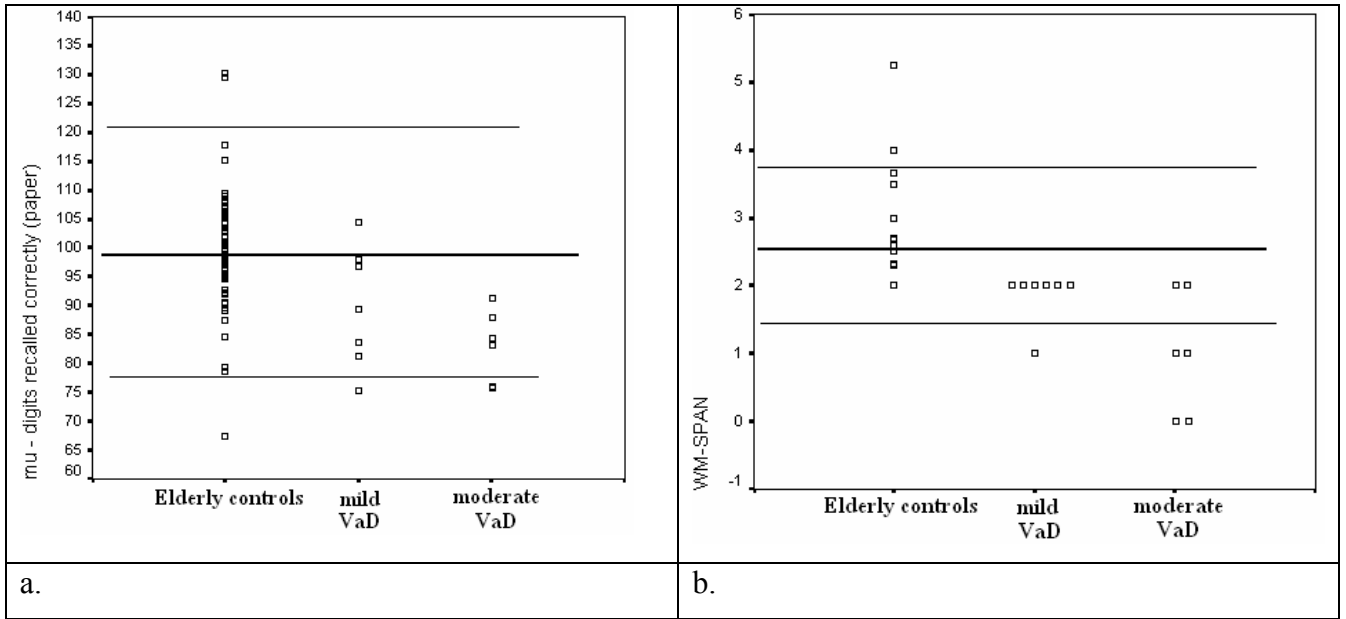

Figure 52. The individual performances on the paper and pencil *mu* scores – digits recalled correctly and the scores on the WMS task.

The comparison of the individual performances on the paper and pencil *mu* scores – lists recalled correctly and the scores on the memory tasks.

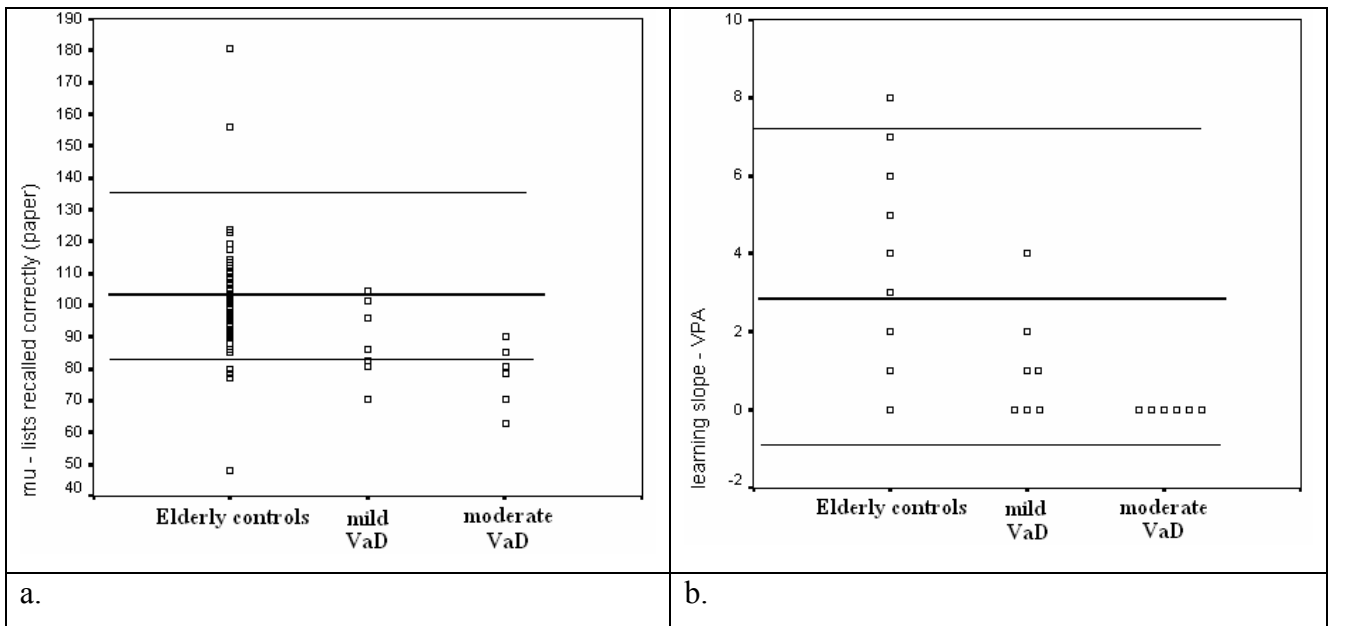

Figure 53. The individual performances on the paper and pencil *mu* scores – lists recalled correctly and the learning slope scores on the VPA task.

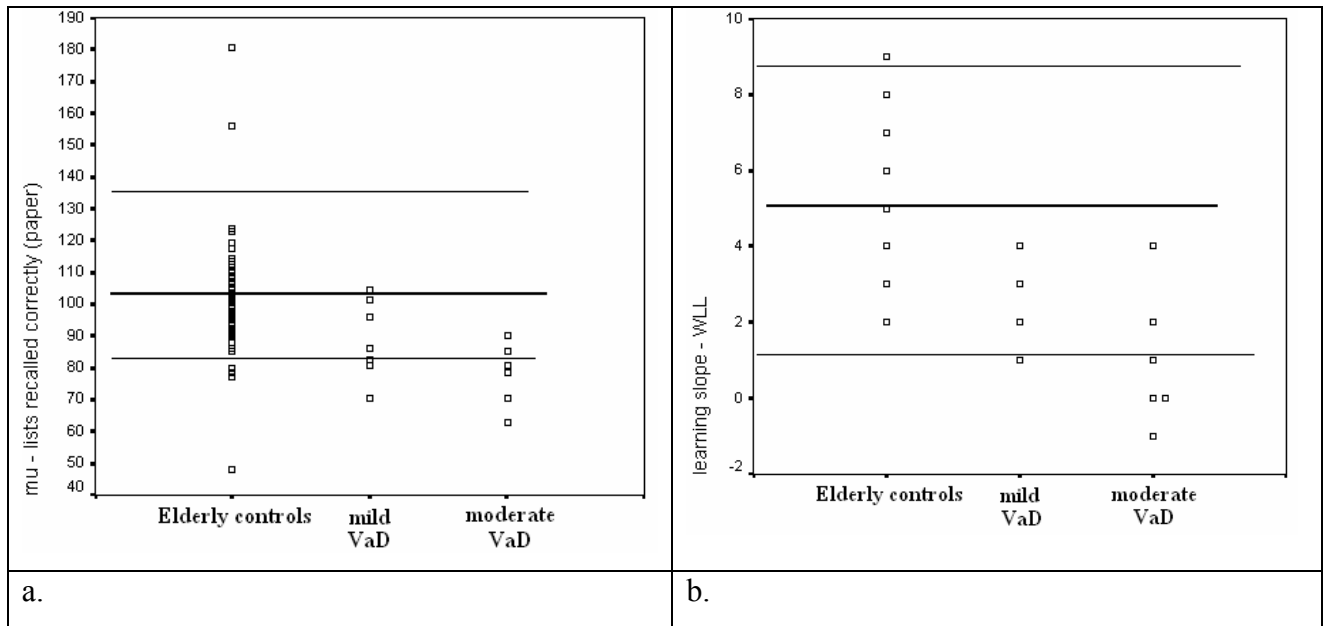

Figure 54. The individual performances on the paper and pencil *mu* scores – lists recalled correctly and the learning slope scores on the WLL task.

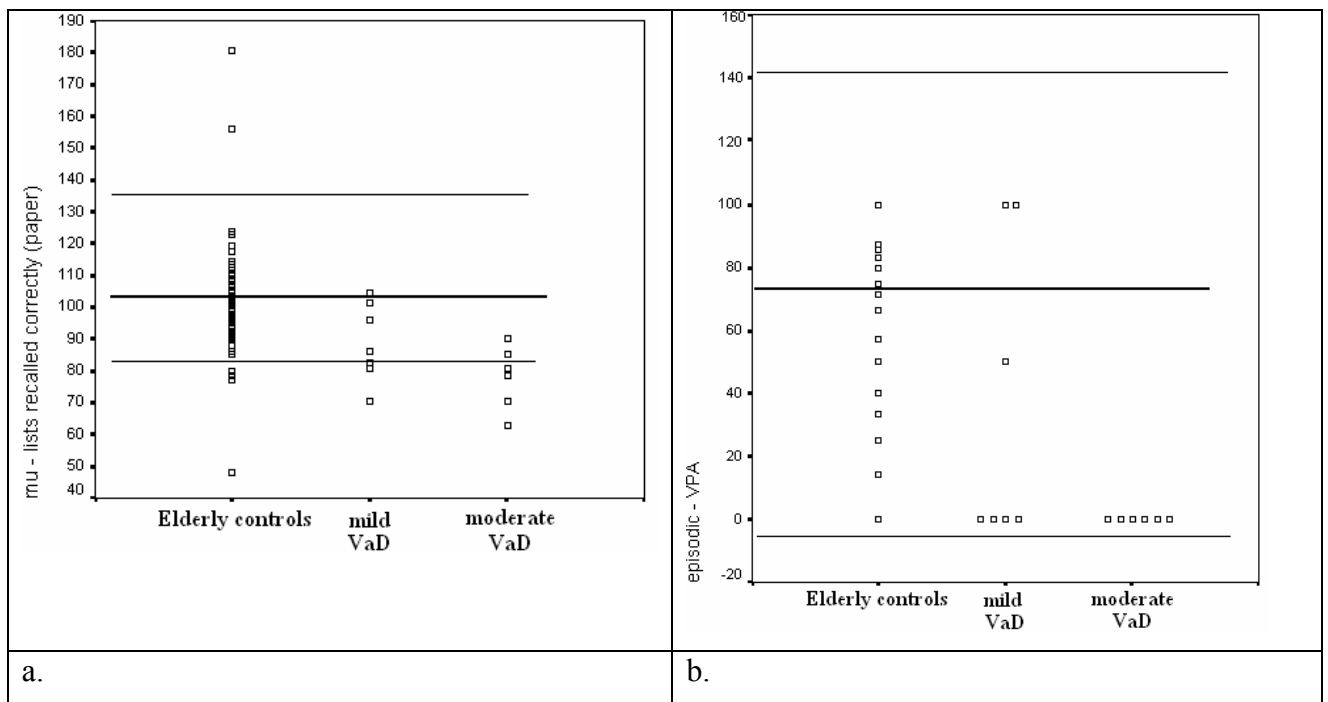

Figure 55. The individual performances on the paper and pencil *mu* scores – lists recalled correctly and the episodic memory scores on the VPA task.

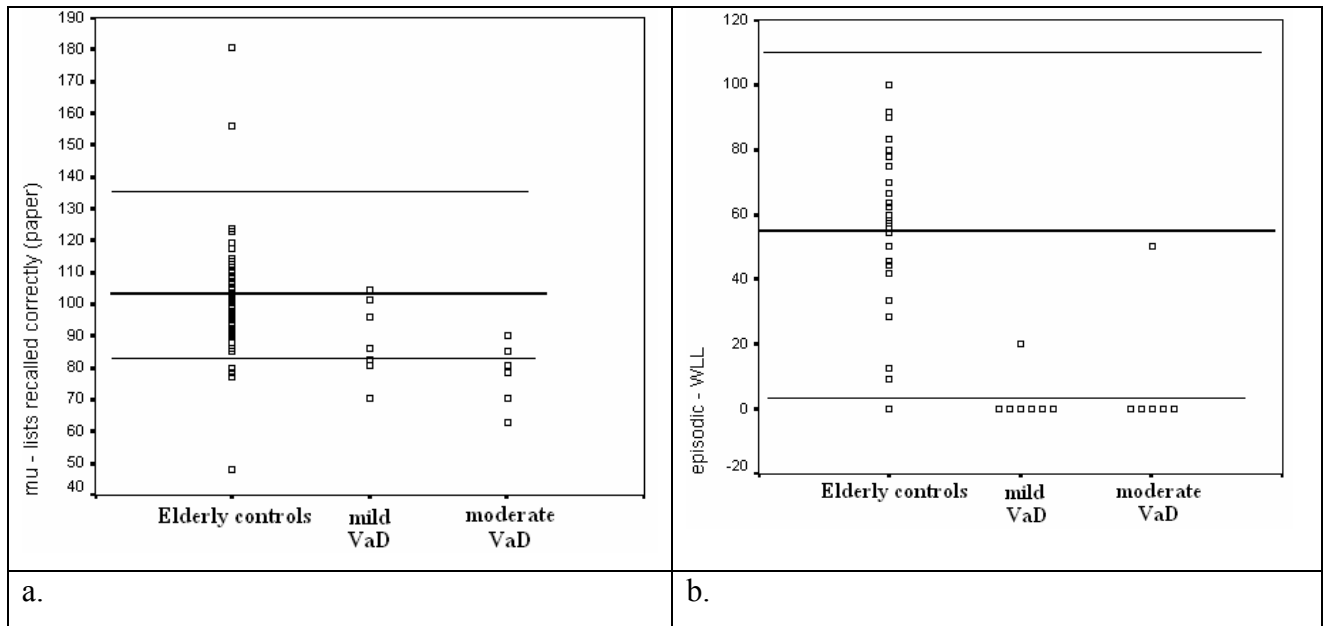

Figure 56. The individual performances on the paper and pencil *mu* scores – lists recalled correctly and the episodic memory scores on the WLL task.

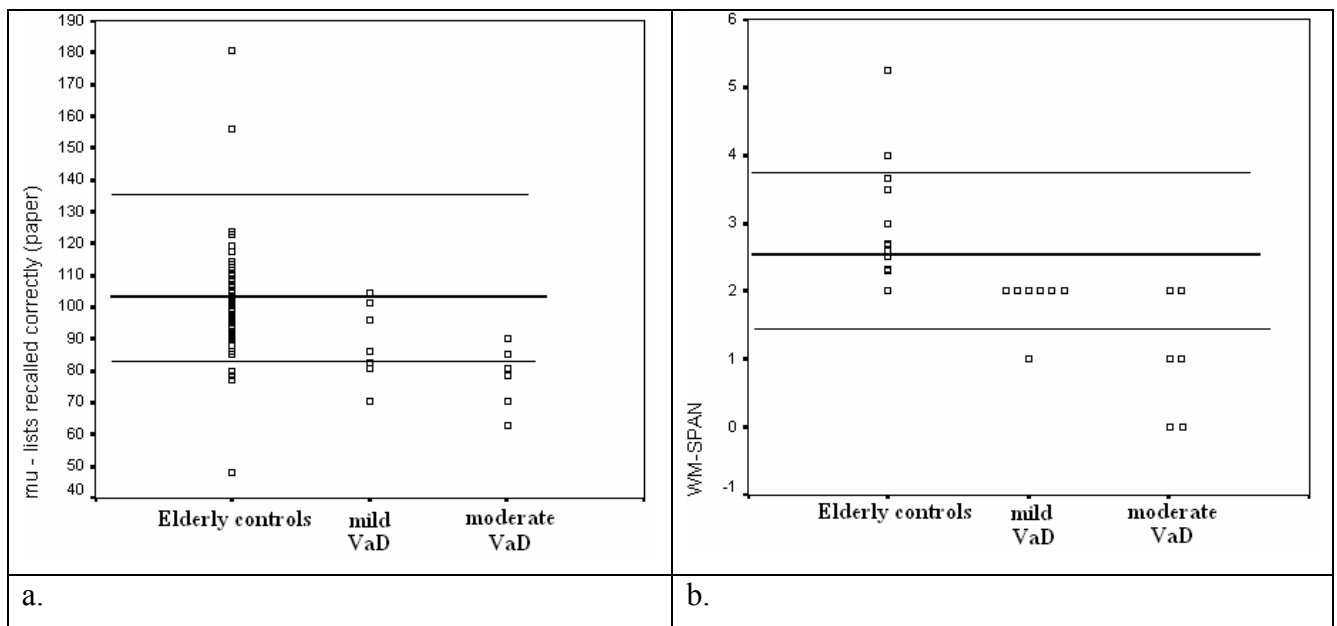

Figure 57. The individual performances on the paper and pencil *mu* scores – lists recalled correctly and the scores on the WMS task.

13.4. Discussion

Experiment 3 showed that ability to learn novel memory associations and semantically unrelated words for the VaD patients was worse than for the healthy controls. Additionally, young participants learned new memory associations better than the elderly participants, but these two groups did not differ in the ability to learn semantically unrelated words.

Episodic memory and WMS task performance showed that the VaD patients were significantly inferior to healthy controls. Healthy elderly participants had worse episodic memory

performance than the young participants. The study groups did not differ from each other on intrusions, or type of intrusions they made for the episodic memory measures.

The comparison of only the two elderly groups – the healthy elderly participants and the VaD patients, confirmed that elderly participants show significantly superior memory performance to the VaD patients. The two groups did not differ nor intrusions and types of intrusions they made.

No significant correlations were observed between episodic memory and dual-task performance for the healthy controls. Only the elderly participants showed a positive correlation between the ability to maintain novel memory associations and the computerised dual-task *mu* score – digits recalled correctly ($r=.519, p<.008$).

No significant correlation was found between working memory capacity and dual-task performance for any of the study groups.

VaD patients also showed no significant correlations between dual-task and episodic memory performance. Significant positive correlations were found between ability for learning semantically unrelated words and the two paper and pencil *mu* scores.

Comparison of the patients' memory performance to the norms of the memory scores and the *mu* scores showed that in respect to the number of the VaD patients that fell outside the $M\pm 2SD$ boundaries, the most difficult task for them was performance of the paper and pencil version of the dual-task, the learning of the new semantically unrelated lists of words (that was confirmed by the found correlations between these two variables), delayed recall of these words – episodic memory and working memory span task. On these tasks more patients fell outside the normative interval. But it should be noted that for the Learning slope of the VPA task, and on two episodic memory tasks patients showed floor effect in performance. The great majority of the VaD patients had zero score on these three tasks and did not show variability in performance.

One can conclude that both cognitive domains – the dual-task and episodic memory performance are impaired in VaD patients in comparison to the healthy controls. Impairment of performance under dual-task condition is not correlated with the existing episodic memory and working memory capacity problems for VaD patients. It can be concluded that deficits of these two cognitive domains could be independent from each other. Since the majority of the VaD patients irrespective of dementia severity levels performed at floor level on the episodic memory tasks, but showed wide spread of scores for the dual-task performance, it can be concluded that even in the early stages of the VaD episodic memory is severely impaired, while dual-task coordination is damaged but still available. It is now necessary to compare the pattern of impairment in these two cognitive domains found for the VaD patients to the pattern which would be produced on AD patients. This issue should be the focus for future research.

14. Conclusions

1. Healthy elderly participants did not perform computerised and paper and pencil versions of the dual-task worse than healthy young subjects.
2. In healthy participants education factor has no effect on dual-task performance.
3. Norms for the computerised and paper and pencil versions of the dual task performance were determined for the Georgian elderly population.
4. VaD patients show decrease in performance levels on one or both single tasks, when it is required to combine them as was shown in AD patients but this was not as robust as was found for the AD patients. The similar central executive function namely the dual-task functioning is damaged in the early stages of VaD and AD.
5. The paper and pencil version of the dual-task is a comparable counterpart of the computerised version of the dual-task. Both versions of the dual-task reveal no age effect on performance under dual-task condition. The paper and pencil version of the dual-task show the same pattern of dual-task decrement in VaD patients as was determined by the computerised version of the dual-task.
6. New, modified, simpler version of the paper and pencil perceptuomotor task was developed, which was named “Tbilisi paper and pencil motor task”. The modified paper and pencil dual-task method is an effective and sensitive tool for detecting cognitive deterioration in early phase of dementia. The method is simple to administer in clinical setting, convenient logistically and replicate previous findings of paper and pencil and computerized version of the dual task.
7. VaD patients were significantly inferior to healthy controls on performance of episodic memory and WMS tasks.
8. There is a differential disturbance of episodic memory performance and central executive functioning, particularly performance of a dual-task paradigm in VaD patients in comparison to age and education matched healthy elderly and education matched young participants. Both cognitive domains – the dual-task and episodic memory performance are impaired in VaD patients in comparison to the healthy controls. The majority of the VaD patients irrespective of dementia severity levels performed at floor level on the episodic memory tasks, but showed wide spread of scores for the dual-task performance. Even in the early stages of the VaD episodic memory is severely impaired, while dual-task coordination is damaged but still available.

9. Impairment of performance under dual-task condition is not correlated with the existing episodic memory and working memory capacity problems for VaD patients. Deficits of these two cognitive domains could be independent from each other.
10. Norms for episodic memory and working memory span (WMS) performance were determined for the Georgian elderly population.
11. According to the comparison of the VaD patients' individual performances to the defined norms and despite the statistically significant decrements in performance under dual-task condition in comparison to the healthy controls (*mu* scores), the great majority of the VaD patients still performed in the limits defined for the performance of the healthy elderly participants.

15. References

- Adams RD, Victor M, Ropper AH. Principles of neurology, sixth edition. McGraw-Hill Companies, Inc., 1997, 1059-1060;
- Alberoni M, Baddeley AD, Della Sala S, Logie RH, Spinnler H. Keeping track of a conversation: impairments in Alzheimer's disease. *Int J Geriatr Psychiatry*, 1992; 7, 639-646;
- Allain P, Etcharry-Bouyx F, Le Gall D. A case study of selective impairment of the central executive component of working memory after a focal frontal lobe damage. *Brain and Cognition*, 2001, 45, 21-43;
- American Psychiatric Association, Diagnostic and Statistical Manual of Mental Disorders, 4th edn. Washington, DC: American Psychiatric Association, 1994;
- Andres P, Van der Linden M. Are central executive functions working in patients with focal frontal lesions? *Neuropsychologia*, 2002, 40, 835-845;
- Bäckman L, Small BJ, Fratiglioni L. Stability of the preclinical episodic memory deficit in Alzheimer's disease. *Brain*, 2001, 124, 96-102;
- Baddeley AD. The concept of episodic memory. *Phil. Trans. Royal Soc. Lond. B*, 2001, 356, 1345-1350;
- Baddeley AD. Working memory. New York: Oxford University Press, 1986;
- Baddeley AD. Exploring the central executive. *The Quarterly Journal of Experimental Psychology*, 1996, 49A (1), 5-28;
- Baddeley AD, Baddeley HA, Bucks RS, Wilcock GK. Attentional control in Alzheimer's disease. *Brain*, 2001, 124, 1492-1508;
- Baddeley AD, Bressi S, Della Sala S, Logie R. & Spinnler H. The decline of working memory in Alzheimer's disease: a longitudinal study. 1991; *Brain*, 114, 2521-2542;
- Baddeley AD, Cocchini G, Della Sala S, Logie R, Spinnler H. Working memory and vigilance: evidence from normal aging and Alzheimer's disease. *Brain and Cognition*, 1999, 41, 87-108;
- Baddeley AD. & Della Sala S. Working memory and executive control. *Philosophical Transactions: Biological Sciences*, 1996, 351(1346), 1397-1404;
- Baddeley AD, Della Sala S, Gray C, Papagno C, Spinnler H. Testing central executive functioning with a pencil-and-paper test. In P. Rabbitt (ed.) *Methodology of frontal and executive function*. Psychology Press, UK, 1997, 61-79;
- Baddeley AD, Kopelman MD, Wilson BA. *The handbook of memory disorders*. (2nd edition). John Wiley & Sons, Ltd, 2002, 8, 64-75;

- Baddeley AD, Logie R, Bressi S, Della Sala S, Spinnler H. Dementia and working memory. *Q J Exp Psycho*, 1986, 38A, 603-618;
- Baddeley AD, Logie R, Nimmo-Smith I, Brereton N. Components of fluent reading. *Journal of Memory and Language*, 1985, 24, 119-131;
- Baddeley AD, Wilson BA. Prose recall and amnesia: implications for the structure of working memory. *Neuropsychologia*, 2002, 40, 1737-1743;
- Bakchine S, Blamchard F. Diagnostic criteria for vascular dementia: a step towards new ones? *Psychogeriatrics*, 2005, 4, 127-129;
- Balota DA, Faust M. Attention in dementia of the Alzheimer type. In Boller F, Grafman J (editors). *Handbook of Neuropsychology* (2nd edition), Vol.6. Amsterdam: Elsevier Science, 2001, 51-80;
- Bathgate D, Snowden JS, Varma A, Blackshaw A, Neary D. Behaviour in frontotemporal dementia, Alzheimer's disease and vascular dementia. *Acta Neurol Scand*, 2001, 103, 367-378;
- Bherer L, Kramer AF, Peterson MS, Colcombe S, Erickson K, Becic E. Training effect on dual-task performance: are there age-related differences in plasticity of attentional control? *Psychology and Aging*, 2005, Vol. 20, No. 4, 695-709;
- Bowler JV. The concept of vascular cognitive impairment. *Journal of the Neurological Science*, 2002, 203-204, 11-15;
- Bowler JV, Hachinski V. Vascular cognitive impairment: a new approach to vascular dementia. In Hachinski V. (editor) *Baillière's Clinical Neurology. Cerebrovascular Disease*. London: Bailliere Tindall, 1995, Vol. 4(2), 357-376;
- Brust JCM. Dementia and cerebrovascular disease. In R. Mayeux and W.G. Rosen (editors) *The Dementias*. Raven Press, New York, 1983, 131-147;
- Cannata AP, Alberoni M, Franceschi M, Mariani C. Frontal impairment in subcortical ischemic vascular dementia in comparison to Alzheimer's disease. *Dement Geriatr Cogn Disord*, 2002, 13, 101-111;
- Cardebat D, Demonet J, Puel M, Agniel A, Viillard G, Celsis P. Brain correlates of memory processes in patients with dementia of Alzheimer's type: a SPECT activation study. *Journal of Cerebral Blood Flow & Metabolism*, 1998, 18, 457-462;
- Casasanto DJ, Killgore WDS, Maldjian JA, Glosser G, Alsop DC, Cooke AM, Grossman M, Detre JA. Neural Correlates of successful and unsuccessful verbal memory encoding. *Brain and Language*, 2002, 80, 287-295;
- Caselli RJ, Boeve BF. The degenerative dementias. In Goetz CG, Pappert E. *Textbook of clinical neurology*, (1st edition). W.B. Saunders Company, 1999, 629-654;

- Cocchini G, Logie R, Della Sala S, MacPherson S & Baddeley AD. Concurrent performance of two memory tasks: Evidence for domain-specific working memory systems. *Memory & Cognition*, 2002, 30 (7), 1086-1095;
- Daselaar SM, Veltman DJ, Rombouts SARB, Raaijmakers JGW, Jonker C. Neuroanatomical correlates of episodic encoding and retrieval in young and elderly subjects. *Brain*, 2003, 126, 43-56;
- Davies RR, Graham KS, Xuereb JH, Williams GB, Hodges JR. The human perirhinal cortex and semantic memory. *European Journal of Neuroscience*, 2004, Vol. 20, 2441-2446;
- Dalla Barba G, Parlato V, Jobert A, Samson Y, Pappata S. Cortical networks implicated in semantic and episodic memory: common or unique? *Cortex*, 1998, 34, 547-561;
- Della Sala S, Baddeley A, Papagno C, Spinnler H. Dual-task paradigm: a means to examine the central executive. *Ann NY Acad Sci*, 1995, 769, 161-171;
- Della Sala S, Gray C, Baddeley A, Allamano N, Wilson L. Pattern span: a tool for unwelding visuo-spatial memory. *Neuropsychologia*, 1999, 37, 1189-1199;
- Della Sala S, Logie RH. Impairments of methodology and theory in cognitive neuropsychology: a case for rehabilitation? *Neuropsychological Rehabilitation*, 1997, 7(4), 367-385;
- Della Sala S, Logie RH. Neuropsychological impairments of visual and spatial working memory. In Baddeley AD, Kopelman MD, Wilson BA (editors). *The Handbook of Memory Disorders*. (2nd edition), England: John Wiley & Sons Ltd 2002, 271-292;
- Della Sala S, Logie RH. Theoretical and practical implications of dual-task performance in Alzheimer's disease. *Brain* 2001; 124, 1479-1481;
- Della Sala S & Logie RH. Working memory. *Encyclopedia of the Human Brain*, Elsevier Science (USA), 2002, Vol. 4, 819-830;
- Della Sala S, Logie RH, Beschin N, Denis M. Preserved visuo-spatial transformation in representational neglect. *Neuropsychologia*, 2004, 42, 1358-1364;
- Della Sala S, Logie RH, Spinnler H. Is primary memory deficit of Alzheimer patients due to a "central executive" impairment? *J Neurolinguistics*, 1992, Vol. 7, 4, 325-346;
- Desgranges B, Baron J, Lalevee C, Giffard B, Viader F, Sayette V, Eustache F. The neural substrates of episodic memory impairment in Alzheimer's disease as revealed by FDG-PET: relationship to degree of deterioration. *Brain*, 2002, 125, 1116-1124;
- Desmond DW. The neuropsychology of vascular cognitive impairment: is there a specific cognitive deficit? *J Neurol Sci*, 2004, 226(1-2), 3-7;
- Di Carlo A, Baldereschi M, Amaducci L, Lepore V, Bracco L, Maggi S, Bonauto S, Perissinotto E, Scarlato G, Farchi G, Inzitari D. Incidence of dementia, Alzheimer's disease, and

vascular dementia in Italy. The ILSA study. *Journal of the American Geriatrics Society*, 2002, 50, 41-48;

Duff S. & Logie RH. Processing and storage in working memory: Cognitive capacity or multiple components? *Quarterly Journal of Experimental Psychology*, 2001, 54A, 31-48;

Engstad T, Almkvist O, Viitanen M, Arnesen E. Impaired motor speed, visuospatial episodic memory and verbal fluency characterize cognition in long-term stroke survivors: the Tromsø Study. *Neuroepidemiology*, 2003, 22, 326-331;

Erkinjuntti T. Cognitive decline and treatment options for patients with vascular dementia. *Acta Neurol Scand*, 2002, 106, 15-18;

Fillit H, Hill J. The costs of vascular dementia: a comparison with Alzheimer's disease. *Journal of the Neurological Science*, 2002, 203-204, 35-39;

Fitzpatrick AL, Kuller LH, Ives DG, Lopez OL, Jagust W, Breitner JC, Jones B, Lyketsos C, Dulberg C. Incidence and prevalence of dementia in the Cardiovascular Health Study. *J Am Geriatr Soc*, 2004, 52(2), 195-204;

Garcia-Villamisar D, Della Sala S. Dual-task performance in adults with autism. *Cognitive Neuropsychiatry*, 2002, 7(1), 63-74;

Garrett KD, Browndyke JN, Whelihan W, Paul RH, DiCarlo M, Moser DJ, Cohen RA, Ott BR. The neuropsychological profile of vascular cognitive impairment – no dementia: comparisons to patients at risk for cerebrovascular disease and vascular dementia. *Archives of Clinical Neuropsychology*, 2004, 19, 745-757;

Garrido GEJ, Furuie SS, Buchpiguel CA, Bottino CMC, Almeida OP, Cid CG, Camargo CHP, Castro CC, Glabus MF, Busatto GF. Relation between medial temporal atrophy and functional brain activity during memory processing in Alzheimer's disease: a combined MRI and SPECT study. *J Neurol Neurosurg Psychiatry*, 2002, 73, 508-516;

Geula C. Abnormalities of neural circuitry in Alzheimer's disease: hippocampus and cortical cholinergic innervation. *Neurology*, 1998, 51, S18-S29;

Ghoshal N, Garcia-Sierra F, Wu J, Leurgans S, Bennett DA, Berry RW, Binder LI. Tau conformation changes correspond to impairments of episodic memory in mild cognitive impairment and Alzheimer's disease. *Experimental Neurology*, 2002, 177, 475-493;

Graham NL, Emery T, Hodges JR. Distinctive cognitive profile in Alzheimer's disease and subcortical vascular dementia. *J Neurol Neurosurg Psychiatry*, 2004, 75, 61-71;

Greene JD, Hodges JR, Baddeley AD. Autobiographical memory and executive function in early dementia of Alzheimer type. *Neuropsychologia*, 1995; 33, 1647-1670;

- Groeger JA. Memory and remembering: Everyday memory in context, Addison Wesley Longman Inc., New York, 1997, 49-61;
- Grön G, Bittner D, Schmitz B, Wunderlich AP, Tomczak R, Riepe MW. Variability in memory performance in aged healthy individuals: an fMRI study. *Neurobiology of Aging*, 2003, 24, 453-462;
- Gruber O. Effects of domain-specific interference on brain activation associated with verbal working memory task performance. *Cerebral Cortex*, 2001, 11, 1047-1055;
- Gyselinck V, Ehrlich MF, Cornoldi C, de Beni R, Dubois V. Visuospatial working memory in learning from multimedia systems. *Journal of Computer Assisted Learning*, 2000, 16, 166-176;
- Hachinski V. Vascular dementia: the need for a new approach. *Journal of Internal Medicine*, 1997, 242, 277-279;
- Hart S, Semple JM, *Neuropsychology and the Dementias*, Taylor & Francis Inc., 1990, 35-37;
- Hartley AA, Little DM. Age-related differences and similarities in dual-task interference. *J Exp Psychol Gen*, 1999, 128, 416-449;
- Hazeltine E, Ruthruff E, Remington RW. The role of input and output modality pairings in dual-task performance: evidence for content-dependent central interference. *Cognitive Psychology*, 2006, 1-55;
- Helkala E, Laulumaa V, Soininen H, Riekkinen PJ. Different error pattern of episodic and semantic memory in Alzheimer's disease and Parkinson's disease with dementia. *Neuropsychologia*, 1989, Vol. 27, No. 10, 1241-1248;
- Holtzer R, Stern Y, Rakitin BC, Predicting age-related dual-task effects with individual differences on neuropsychological testing. *Neuropsychology*, 2005, Vol. 19, No. 1, 18-27;
- Ikeda M. Prevention and early intervention for vascular dementia in community dwelling elderly: finding from Nakayama study. *Psychogeriatrics*, 2003, 4, 17-20;
- Kalaria R. Similarities between Alzheimer's disease and vascular dementia. *Journal of the Neurological Sciences*, 2002, 29-34;
- Kemper S, Herman RE, Lian CHT. The cost of doing two things at once for young and older adults: talking while walking, finger tapping, and ignoring speech or noise. *Psychology and Aging*, 2003, Vol. 18, No. 2, 181-192;
- Kitabayashi Y, Ueda H, Narumoto J, Nakamura K, Kita H, Fukui K. Qualitative analyses of clock drawings in Alzheimer's disease and vascular dementia. *Psychiatry and Clinical Neurosciences*, 2001, 55, 485-491;
- Kiyohara Y. Prevalence, incidence, and risk factors of vascular dementia: the Hisayama study. *Rinsho Shinkeigaku*, 1999, 39(1), 47-49;

- Knopman DS, Rocca WA, Cha RH, Edland SD, Kokmen E. Incidence of Vascular Dementia in Rochester, Minn, 1985-1989, *Arch Neurol*, 2002, 59, 1605-1610;
- Korczyn AD. The complex nosological concept of vascular dementia. *Journal of the Neurological Sciences*, 2002, 203-204, 3-6;
- Kramer JH, Reed BR, Mungas D, Weiner MW, Chui HC. Executive dysfunction in subcortical ischaemic vascular disease. *J Neurol Neurosurg Psychiatry*, 2002, 72, 217-220;
- Lambon Ralph MA, Patterson K, Graham N, Dawson K, Hodges JR. Homogeneity and heterogeneity in mild cognitive impairment and Alzheimer's disease: a cross-sectional and longitudinal study of 55 cases. *Brain*, 2003, 126, 2350-2362;
- Laukka EJ, Jones S, Fratiglioni L, Bäckman L. Cognitive functioning in preclinical vascular dementia a 6-year follow-up. *Stroke*, 2004, 1805-1809;
- Lawrence RM. Is the finding of obsessional behaviour relevant to the differential diagnosis of vascular dementia of the Binswanger type? *Behavioural Neurology*, 2000, 12, 149-154;
- Leys D, Pasquier F, Parnetti L. Epidemiology of vascular dementia. *Haemostasis*, 1998, 28(3-4), 134-150;
- Lezak MD. Multi-infarct dementia, In M. D. Lezak (editor), *Neuropsychological Assessment* (3rd edition), New York: Oxford University Press, 1995, 200-203;
- Lindsay J, Laurin D, Verreault R, Hebert R, Helliwell B, Hill GB, McDowell I. Risk factors for Alzheimer's disease: a prospective analysis from the Canadian Study of Health and Aging. *Am J Epidemiol.*, 2002, Sep 1, 156(5), 445-53;
- Logie RH, Della Sala S. Working memory, psychology of. In *International encyclopedia of the social sciences*, Elsevier Science Ltd, 2001, 16587-16593;
- Logie R, Cocchini G, Della Sala S, MacPherson S, Baddeley AD. Is there a specific executive capacity for dual task coordination? Evidence from Alzheimer's disease, *Neuropsychology*, 2004, Vol. 18, No. 3, 504-513;
- Logie RH, Della Sala S, Cocchini G, Baddeley AD. Coordination of dual-task performance in working memory. *Proc Psychonom Soc*, 2000, 54;
- Logie RH, Venneri A, Della Sala S, Redpath TW, Marshall I. Brain activation and the phonological loop: the impact of rehearsal. *Brain and Cognition*, 2003, 53, 293-296;
- Looi JCL & Sachdev PS. The differentiation of vascular dementia from Alzheimer's disease on neuropsychological test performance. *Neurology* 52, 670-678, 1999;
- Lopez-Pousa S, Vilalta-Franch J, Llinas-Regla J, Garre-Olmo J, Roman GC. Incidence of dementia in a rural community in Spain: the Girona cohort study. *Neuroepidemiology*, 2004, 23(4), 170-177;

- MacPherson SE, Della Sala S, Logie RH. Dual-task interference on encoding and retrieval processes in healthy and impaired working memory. *Cortex*, 2004, 40, 183-184;
- MacPherson SE, Cummings JL. Neuropsychological aspects of vascular dementia. *Brain and Cognition*, 1996, 31, 269-282;
- Madureira S, Guerreiro M, Ferro MJ. Dementia and cognitive impairment three months after stroke. *European Journal of Neurology*, 2001, 8: 621-627;
- Markesbery WR. Vascular dementia, In Markesbery W. R (ed.) *Neuropathology of dementing disorders*, Oxford University Press, 1998, 293-311;
- Mauri M, Sibilla L, Bono G, Carlesimo GA, Sinforiani E, Martelli A. The role of morpho-volumetric and memory correlations in the diagnosis of early Alzheimer dementia. *J Neurol*, 1998, 245, 525-530;
- Mendelsohn G. The development of a dual-task technique, involving a motor task based upon Fitts' law, to test the central executive deficit associated with dementia of the Alzheimer type. Thesis submitted as part fulfillment of the degree requirements for BSc (Hons) Psychology at the University of Aberdeen, March 1995, 6-9;
- Mendez MF, Cherrier MM, Perryman KM. Differences between Alzheimer's disease and vascular dementia on information processing measures. *Brain and Cognition*, 1997, 34, 301-310;
- Menon V, Boyett-Anderson JM, Schatzberg AF, Reiss AL. Relating semantic and episodic memory systems. *Cognitive Brain Research*, 2002, 13, 261-265;
- Meyer JS, Rauch GM, Lechner H, Loeb C. Vascular dementia, *Brain*, 2001, 124, 1877-1885;
- Miyake A., Friedman NP, Emerson MJ, Witzki AH, Howerter A. The unity and diversity of executive functions and their contributions to complex "frontal lobe" task: a latent variable analysis. *Cognitive Psychology*, 2000, 41, 49-100;
- Miyake A. & Shah P. *Models of Working Memory*. Cambridge University Press, 1999, 13, 38, 103-104, 107, 110, 158, 264, 286-287, 395, 425, 456;
- Nilsson L. Memory function in normal aging. *Acta Neurol Scand*, 2003, 107 (Suppl. 179), 7-13;
- O'Brien J, Lilienfeld S. Relevant clinical outcomes in probable vascular dementia and Alzheimer's disease with cerebrovascular disease. *Journal of the Neurological Sciences*, 2002, 203-204, 41-48;
- Owen AM, Herrod NJ, Menon DK, Clark JC, Downey SPMJ, Carpenter TA, Minhas PS, Turkheimer FE, Williams EJ, Robbins TW, Sahakian BJ, Petrides M, Pickard JD. Redefining the

functional organization of working memory processes within human lateral prefrontal cortex. *European Journal of Neuroscience*, 1999, 11, 567-574;

Owen AM, Stern CE, Look RB, Tracey I, Rosen BR. Functional organization of spatial and nonspatial working memory processing within the human lateral frontal cortex. *Procl. Natl. Acad. Sci.*, 1998, 95, 7721-7726;

Pasquier F, Henon H, Leys D. Relevance of white matter changes to pre- and poststroke dementia. *Ann N Y Acad Sci.* 2000 Apr., 903, 466-469;

Perry RJ, Watson P, Hodges JR. The nature and staging of attention dysfunction in early (minimal and mild) Alzheimer's disease: relationship to episodic and semantic memory impairment. *Neuropsychologia*, 2000, 38, 252-271;

Pickering SJ. The development of visuo-spatial working memory. *Memory*, 2001, 9 (4/5/6), 423-432;

Ranganath C, Jonson MK, D'Esposito M. Prefrontal activity associated with working memory and episodic long-term memory. *Neuropsychologia*, 2003, 41, 378-389;

Riekse RG, Leverenz JB, McCormick W, Bowen JD, Teri L, Nochlin D, Simpson K, Charisma E, Larson EB, Tsuang D. Effect of vascular lesions on cognition in Alzheimer's disease: a community-based study. *J Am Geriatr Soc*, 2004, 52, 1442-1448;

Rockwood K., Macknight C., Wentzel C. et al. The diagnosis of "mixed dementia" in the consortium for the investigation of vascular impairment of cognition (CIVIC). *Ann N Y Acad Sci*, 903, 522-528, 2000;

Roman GC, Sachdev P, Royall DR, Bullock RA, Orgogozo JM, Lopez-Pousa S, Arizaga R, Wallin A. Vascular cognitive disorder: a new diagnostic category updating vascular cognitive impairment and vascular dementia. *J Neurol Sci*, 2004, 226(1-2), 81-87;

Ruitenbergh A, Ott A, van Swieten JC, Hofman A, Breteler MM. Incidence of dementia: does gender make a difference? *Neurobiol Aging*, 2001, 22(4), 575-580;

Sachdev PS, Brodaty H, Valenzuela MJ, Lorentz L, Looi JCL, Wen W, Zagami AS. The neuropsychological profile of vascular cognitive impairment in stroke and TIA patients. *Neurology*, 2004, 62, 912-919;

Sachdev PS, Brodaty H. Vascular dementia: An Australian perspective. *Alzheimer Disease and Associated Disorders*, Lippincott Williams & Wilkins, Inc., Philadelphia, 1999, Vol. 13, Suppl. 3, S206-S212;

Schmidtke K, Hüll M. Neuropsychological differentiation of small vessel disease, Alzheimer's disease and mixed dementia. *Journal of the Neurological Science* 2002, 203-204, 17-22;

Souchay C, Isingrini M, Gil R. Alzheimer's disease and feeling-of-knowing in episodic memory. *Neuropsychologia*, 2002, 40, 2386-2396.

Spinnler H. The role of attention disorders in the cognitive breakdown of dementia. In Boller F, Grafman J (editors). *Handbook of Neuropsychology* (1st edition), Vol. 5. Amsterdam: Elsevier Science, 1991, 79-122;

Suh G, Kim KK, Cho MJ. Community study of dementia in the older Korean rural population. *Australian and New Zealand Journal of Psychiatry*, 2003, 37, 606-612;

Suh G, Shah A. A review of the epidemiological transition in dementia – cross-national comparisons of the indices related to Alzheimer's disease and vascular dementia. *Acta Psychiatr Scand*, 2001, 104, 4-11;

Szameitat AJ, Schubert T, Muller K, Yves von Cramon D. Localization of executive function in dual-task performance with fMRI. *Journal of Cognitive Neuroscience*, 2002, 1184-1199;

Szirmai I, Vastagh I, Szombathelyi E, Kamondi A. Strategic infarcts of the thalamus in vascular dementia. *Journal of the Neurological Sciences*, 2002, 203-204, 91-97;

Urakami K. Vascular factors in Alzheimer's disease. *Psychogeriatrics*, 2004, 4, 124-126;

Varma AR, Adams W, Lloyd JJ, Carson KJ, Snowden JS, Testa HJ, Jackson A, Neary D. Diagnostic patterns of regional atrophy on MRI and regional cerebral blood flow change on SPECT in young onset patients with Alzheimer's disease, frontotemporal dementia and vascular dementia. *Acta Neurol Scand*, 2002, 105:261-269;

Verhaeghen P, Steitz DW, Sliwinski MJ, Cerella J. Aging and dual-task performance: a meta-analysis. *Psychology and Aging*, 2003, Vol. 18, No. 3, 443-460;

Voss SE, Bullock RA. Executive function: the core feature of dementia? *Dement Geriatr Cogn Disord*, 2004, 18, 207-216;

Wang Q, Zhou J. Retrieval and encoding of episodic memory in normal aging and patients with mild cognitive impairment. *Brain Research*, 2002, 924, 113-115;

Wechsler D. Wechsler Memory Scale – third edition, Administration and scoring manual. UK project directors: Wycherley RJ, Benjamin L. The Psychological Corporation, Harcourt Brace & Company, Publishers, 1998, 3-4, 56-57, 61-62, 75-76, 79-80;

Wilson RS, Fleischman DA, Myers RA, Bennett DA, Bienias JL, Gilley DW, Evans DA. Premorbid proneness to distress and episodic memory impairment in Alzheimer's disease. *J Neurol Neurosurg Psychiatry*, 2004, 75, 191-195;

World Health Organization. ICD-10 Classification of Mental and Behavioral Disorders: Clinical Descriptions and Diagnostic Guidelines. 1992, Geneva: WHO, 50-51;

Yamada M, Kasagi F, Sasaki H, Masunari N, Mimori Y, Suzuki G. Association between dementia and midlife risk factors: the Radiation Effects Research Foundation Adult Health Study. *Journal of the American Geriatrics Society*, 2003, 51, 410-414;

Yamada T, Kadekaru H, Matsumoto S, Inada H, Tanabe M, Moriguchi EH, Moriguchi Y, Ishikawa P, Ishikawa AG, Taira K, Yamori AY. Prevalence of dementia in the older Japanese-Brazilian population. *Psychiatry and Clinical Neurosciences*, 2002, 56, 71-75;

Zekry D, Hauw J, Gold G. Mixed dementia: epidemiology, diagnosis, and treatment. *Progress in geriatrics. JAGS*, 2002, 50, 1431-1438.

16. Acknowledgments

I would like to express sincere thanks to my supervisor, Sergio Della Sala, who really supported me over the last three years, always being ready to discuss any theoretical or practical problems I might have.

I would like to thank Robert Logie who made great contribution to my work by advises and support.

I want to thank INTAS foundation for financial support of my PhD application (INTAS Young Scientist Fellowship Call 2004 for PhD preparation, INTAS Ref. Nr 04-83-3062).

Many thanks to my Georgian supervisor, Roman Shakarishvili for great attention and time devoted to my work.

I would like to express my special thanks to Tinatin Chikovani; without her support it would be imposible to performe and complete my work.

Many thanks to David Chavchanidze whos help I received always I needed it and by whos defenc I encountered minimal problems in the difficult way of preparation of my work.

I would like to thank Ia Pantsulaia for great help and timely support in all formal processes of preparation of required documents.

Special thanks to Elaine Niven who spent many days on correction of English spelling and grammar of my thesis.

I would like to thank Nunu Laitadze who helped me with the selection of patients and made real performance of my work.

I would like to thank Peter Bates and Sarah MacPherson who helped me to prepare experimental stimuli and tasks.

Special thanks to Tamar Malishava who helped me in conduction of experiments.

Many thanks to Lia Gomelauri, Lia Begeladze who always were ready help me.

I also want to thank Maia Beridze, who helped me in making neurological diagnosis of patients.

Many thanks to all my friends and relatives who participated in experiments.

Finally, a special thanks to my family members that were supported me in all difficult situations spiritually and financially.

Many thanks.

17. Appendix

Table 1. Table for converting raw scores to proportions.

Lgth. of list	Score										
	0	1	2	3	4	5	6	7	8	9	10
2	0	.5	1								
3	0	.33	.67	1							
4	0	.25	.5	.75	1						
5	0	.2	.4	.6	.8	1					
6	0	.17	.33	.5	.67	.83	1				
7	0	.14	.29	.43	.57	.71	.86	1			
8	0	.13	.25	.38	.5	.63	.75	.88	1		
9	0	.11	.22	.33	.44	.56	.67	.78	.89	1	
10	0	.1	.2	.3	.4	.5	.6	.7	.8	.9	1

Table 2. Raw data of the presented study.

` Education matched young participants to VaD patients.

`` Age and education matched healthy elderly to VaD patients.

``` Selected VaD patients.

Part 1.

|      | sex | age | age_cod | Education<br>years | Education<br>code | MMSE | WM<br>span | Digit<br>span | Single<br>memory<br>digits | Single<br>memory<br>lists | Dual<br>memory<br>comput.<br>digits | Dual<br>memory<br>comput.<br>lists |
|------|-----|-----|---------|--------------------|-------------------|------|------------|---------------|----------------------------|---------------------------|-------------------------------------|------------------------------------|
| 1``  | 1   | 72  | 2       | 15                 | 1                 | 30   | 2          | 6             | .7830                      | .4000                     | .7830                               | .3000                              |
| 2``  | 2   | 65  | 2       | 15                 | 1                 | 30   | 3          | 4             | .9166                      | .8000                     | .9722                               | .8333                              |
| 3``  | 2   | 64  | 2       | 15                 | 1                 | 29   | 2          | 4             | .8382                      | .6471                     | .8500                               | .5333                              |
| 4``  | 2   | 66  | 2       | 16                 | 1                 | 30   | 2          | 5             | .7167                      | .4167                     | .8867                               | .8000                              |
| 5``  | 2   | 67  | 2       | 16                 | 1                 |      | 2          | 5             | .7455                      |                           | .7692                               |                                    |
| 6    | 1   | 19  | 1       | 12                 | 2                 | 30   | 3          | 4             | .8611                      | .7778                     | .9625                               | .9000                              |
| 7    | 2   | 19  | 1       | 12                 | 2                 | 28   | 3          | 5             | .8857                      | .7143                     | .6923                               | .2308                              |
| 8    | 2   | 64  | 2       | 17                 | 1                 | 29   | 2          | 4             | .8529                      | .5882                     | .8810                               | .7143                              |
| 9``  | 2   | 60  | 2       | 15                 | 1                 | 29   | 3          | 5             | .9600                      | .9286                     | .8750                               | .6875                              |
| 10   | 2   | 52  | 2       | 15                 | 1                 | 30   | 2.5        | 4             | .9125                      | .8500                     | .9457                               | .9130                              |
| 11`  | 2   | 21  | 1       | 15                 | 2                 | 30   | 4          | 6             | .9033                      | .6667                     | .7217                               | .3333                              |
| 12`` | 2   | 65  | 2       | 15                 | 1                 | 29   | 2.3        | 4             | .9306                      | .8889                     | .9167                               | .8095                              |
| 13`` | 1   | 69  | 2       | 16                 | 1                 | 30   | 2.5        | 4             | .8833                      | .7333                     | .9375                               | .8500                              |
| 14`` | 1   | 67  | 2       | 16                 | 1                 | 28   | 3          | 4             | .9444                      | .8333                     | .7941                               | .5882                              |
| 15   | 1   | 17  | 1       | 12                 | 2                 | 30   | 2.5        | 5             | .8000                      | .5000                     | .8400                               | .7333                              |
| 16`` | 2   | 59  | 2       | 17                 | 1                 | 30   | 2          | 4             | 1.0000                     | 1.0000                    | 1.0000                              | 1.0000                             |
| 17   | 1   | 65  | 2       | 16                 | 1                 | 29   | 2          | 6             | .9500                      | .9167                     | .6700                               | .4545                              |
| 18   | 2   | 50  | 2       | 16                 | 1                 | 30   | 3          | 4             | .9440                      | .8333                     | .9545                               | .9091                              |
| 19`` | 1   | 70  | 2       | 16                 | 1                 | 29   | 5.25       | 5             | .9100                      | .8947                     | 1.0000                              | .8571                              |
| 20   | 2   | 52  | 2       | 14                 | 3                 | 20   | 2          | 4             | .8300                      | .5625                     | .8300                               | .5556                              |
| 21`` | 1   | 69  | 2       | 16                 | 1                 | 29   | 2          | 5             | .8500                      | .6923                     | .7900                               | .4286                              |
| 22   | 2   | 19  | 1       | 14                 | 2                 | 30   | 4.8        | 5             | .9100                      | .7143                     | 1.0000                              | 1.0000                             |
| 23`  | 2   | 19  | 1       | 17                 | 2                 | 30   | 5          | 6             | 1.0000                     | 1.0000                    | .8500                               | .6154                              |
| 24   | 2   | 20  | 1       | 14                 | 2                 | 30   | 3          | 5             | .9500                      | .8667                     | .7200                               | .4667                              |
| 25`  | 2   | 20  | 1       | 15                 | 2                 | 30   | 3.67       | 5             | .8941                      | .8235                     | 1.0000                              | 1.0000                             |
| 26   | 2   | 18  | 1       | 12                 | 2                 | 30   | 2.5        | 5             | .8000                      | .6429                     | .8118                               | .7647                              |

|      |   |    |   |      |   |    |      |   |        |        |        |        |
|------|---|----|---|------|---|----|------|---|--------|--------|--------|--------|
| 27   | 2 | 20 | 1 | 13   | 2 |    | 2.5  | 5 | .7429  |        | .9000  |        |
| 28`  | 2 | 20 | 1 | 14   | 2 | 30 | 3    | 6 | .8336  | .7273  | .8977  | .7692  |
| 29`  | 1 | 17 | 1 | 7    | 4 | 30 | 3    | 5 | .8800  | .7333  | .8353  | .5882  |
| 30   | 2 | 19 | 1 | 12   | 2 | 30 | 2.3  | 5 | .9889  | .9444  | .9800  | .9500  |
| 31`` | 1 | 68 | 2 | 16   | 1 | 30 | 2.5  | 5 | .9429  | .7857  | .9333  | .7778  |
| 32`` | 1 | 72 | 2 | 16   | 1 |    |      | 4 | .8500  |        | .8875  |        |
| 33`` | 2 | 73 | 3 | 16   | 1 | 11 | 0    | 3 | .7075  | .5625  | .7253  | .5294  |
| 34   | 1 | 20 | 1 | 13   | 2 | 30 | 3    | 4 | .9306  | .8889  | .8646  | .7083  |
| 35   | 1 | 18 | 1 | 13   | 2 | 30 | 2    | 4 | .9000  | .8000  | .8095  | .7143  |
| 36   | 1 | 20 | 1 | 13   | 2 |    | 2.5  | 5 | .7077  |        | .5733  |        |
| 37   | 1 | 17 | 1 | 12   | 2 |    | 2    | 5 |        |        |        |        |
| 38   | 1 | 17 | 1 | 12   | 2 |    | 3.25 | 5 | .9500  |        | .9882  |        |
| 39`` | 2 | 70 | 3 | 16   | 1 | 18 | 2    | 5 | .9615  | .8846  | .9273  | .7727  |
| 40   | 2 |    |   |      |   |    |      |   |        |        |        |        |
| 41   | 2 |    |   |      |   |    |      |   |        |        |        |        |
| 42`  | 2 | 25 | 1 | 17   | 1 | 30 | 2.5  | 5 | .7714  | .5714  | .8286  | .6429  |
| 43`  | 2 | 21 | 1 | 15   | 1 | 29 | 2.33 | 4 | .9625  | .8500  | .9432  | .8182  |
| 44   | 1 | 53 | 2 | 15   | 1 | 30 | 3    | 5 | .9176  | .8235  | .9222  | .8333  |
| 45`` | 2 | 58 | 2 | 13.5 | 3 | 29 | 2    | 4 | 1.0000 | 1.0000 | .9807  | .9615  |
| 46   | 2 | 58 | 2 | 17   | 1 | 30 | 2.67 | 4 | .9079  | .7895  | .9091  | .7727  |
| 47   | 2 | 64 | 2 | 17   | 1 | 29 | 2.33 | 4 | .9861  | .9444  | .9762  | .9524  |
| 48`` | 2 | 73 | 3 | 12   | 3 | 25 | 2    | 3 | .9896  | .9688  | .8759  | .8148  |
| 49`` | 2 | 63 | 2 | 12   | 3 | 28 | 2.5  | 5 | .8667  | .6190  | .8667  | .5833  |
| 50   | 2 | 23 | 1 | 16   | 1 | 30 | 2    | 4 | .9396  | .8966  | .6944  | .5000  |
| 51   | 1 | 67 | 2 | 17   | 1 | 30 | 3.5  | 6 | .9826  | .9474  | .5455  | .2727  |
| 52`  | 2 | 25 | 1 | 17   | 1 | 30 | 4.2  | 5 | .9629  | .9259  | .8625  | .6250  |
| 53`` | 2 | 72 | 3 | 17   | 1 | 11 | 0    | 3 | .8544  | .6000  | .6677  | .3077  |
| 54   | 1 | 58 | 2 | 16   | 1 | 29 | 2.67 | 6 | .8765  | .7826  | .8200  | .5385  |
| 55   | 2 | 54 | 2 | 8    | 4 | 27 | 2    | 4 | .9500  | .9333  | .5535  | .2143  |
| 56   | 2 | 60 | 2 | 16   | 1 | 30 | 2.5  | 4 | .9265  | .8235  | .9200  | .8000  |
| 57`` | 2 | 56 | 2 | 10   | 4 | 29 | 2    | 4 | .8966  | .7931  | .9211  | .8421  |
| 58   | 2 | 19 | 1 | 13   | 2 | 30 | 2.5  | 4 | .8676  | .7647  | .8636  | .7273  |
| 59`  | 2 | 20 | 1 | 17   | 2 | 30 | 2.67 | 5 | .6714  | .5000  | .7600  | .4667  |
| 60   | 2 | 12 | 1 | 12   | 2 | 30 | 2.67 | 6 | .7670  | .5000  | .9615  | .9231  |
| 61`  | 2 | 24 | 1 | 17   | 1 | 30 | 3    | 6 | 1.0000 | 1.0000 | .8192  | .5833  |
| 62   | 2 | 17 | 1 | 11   | 4 | 30 | 2.5  | 4 | 1.0000 | 1.0000 | .9565  | .9130  |
| 63`  | 2 | 17 | 1 | 17   | 1 | 29 | 2.5  | 6 | .9869  | .9231  | .9113  | .8667  |
| 64`` | 1 | 72 | 3 | 15   | 1 | 21 | 2    | 3 | .9494  | .9091  | .9645  | .9362  |
| 65`  | 1 | 25 | 1 | 15   | 1 | 29 | 3    | 5 | .8460  | .6154  | .9200  | .8000  |
| 66`` | 2 | 70 | 3 | 16   | 1 | 25 | 2    | 5 | .9619  | .8571  | .9333  | .8333  |
| 67`` | 1 | 57 | 3 | 17   | 1 | 25 | 1    | 4 | .9866  | .8621  | .8523  | .6818  |
| 68`  | 1 | 23 | 1 | 17   | 1 | 30 | 4    | 6 | 1.0000 | 1.0000 | .9485  | .8462  |
| 69   | 1 | 47 | 3 | 10   | 4 | 21 | 2    | 3 | .9395  | .8636  | .9505  | .8500  |
| 70`` | 1 | 58 | 3 | 14   | 3 | 21 | 2    | 2 | .8919  | .7838  | .8723  | .7447  |
| 71`  | 1 | 23 | 1 | 17   | 1 | 30 | 2.5  | 5 | .9852  | .9630  | .8308  | .6923  |
| 72   | 1 | 20 | 1 | 12   | 3 | 29 | 3    | 4 | .9444  | .8333  | .9646  | .9167  |
| 73   | 2 | 18 | 1 | 13   | 2 | 30 | 3    | 5 | .9478  | .8696  | .7571  | .5000  |
| 74`` | 2 | 75 | 3 | 11   | 4 | 15 | 1    | 4 | .9531  | .8750  | .8810  | .7143  |
| 75   | 2 | 50 | 2 | 16   | 1 | 30 | 2.67 |   | .9238  | .8095  | .8167  | .5833  |
| 76   | 2 | 19 | 1 | 13   | 2 | 30 | 3    | 5 | .8333  | .5833  | .8769  | .6154  |
| 77   | 1 | 66 | 2 | 17   | 1 | 29 | 2    | 5 | .9333  | .8333  | .8769  | .7692  |
| 78   | 1 | 25 | 1 | 11   | 4 | 30 | 6    | 8 | .9427  | .6667  | .8761  | .5000  |
| 79   | 2 | 52 | 2 | 11   | 3 | 29 | 2.5  | 4 | 1.0000 | 1.0000 | .9762  | .9048  |
| 80   | 1 | 17 | 1 | 11   | 4 | 29 | 3.5  | 8 | .9341  | .8235  | .9680  | .7333  |
| 81   | 1 | 25 | 1 | 16   | 1 | 29 | 3    | 5 | .9130  | .6957  | .8667  | .5333  |
| 82   | 1 | 54 | 2 | 16   | 1 | 30 | 2.5  | 4 | .9865  | .9730  | 1.0000 | 1.0000 |
| 83   | 1 | 50 | 2 | 16   | 1 | 30 | 3.5  | 5 | .9043  | .7826  | .8625  | .6875  |
| 84   | 2 | 64 | 2 | 17   | 1 | 30 | 2.5  | 4 | .9224  | .8276  | .9432  | .8636  |

|       |   |    |   |    |   |    |      |   |        |        |        |        |
|-------|---|----|---|----|---|----|------|---|--------|--------|--------|--------|
| 85    | 2 | 52 | 2 | 11 | 3 | 29 | 2    | 4 | .9924  | .9697  | .8977  | .7727  |
| 86    | 2 | 22 | 1 | 16 | 1 | 30 | 3.2  | 6 | .9762  | .9524  | .9286  | .8571  |
| 87`   | 2 | 22 | 1 | 16 | 1 | 30 | 3    | 5 | .9040  | .7600  | .8133  | .6667  |
| 88`   | 2 | 24 | 1 | 17 | 1 | 30 | 2.6  | 5 | .8800  | .6800  | .7467  | .4667  |
| 89`   | 2 | 22 | 1 | 16 | 1 | 27 | 2.67 | 5 | .8800  | .7200  | .8706  | .7647  |
| 90    | 2 | 23 | 1 | 16 | 1 | 30 | 3    | 7 | .9412  | .8235  | .9042  | .6667  |
| 91    | 2 | 22 | 1 | 16 | 1 | 30 | 3    | 7 | .9528  | .7778  | .7400  | .4545  |
| 92``  | 1 | 55 | 3 | 11 | 3 | 18 | 1    | 5 | .8500  | .6250  | .7556  | .3333  |
| 93    | 2 | 48 | 3 | 15 | 1 | 17 | 0    | 3 | .9613  | .8750  | .9572  | .9487  |
| 94    | 2 | 50 | 2 | 15 | 1 | 29 | 3    | 5 | .8476  | .6190  | .8571  | .6429  |
| 95``  | 2 | 64 | 2 | 16 | 1 | 28 | 2.67 | 6 | .9286  | .8095  | .8475  | .6667  |
| 96    | 2 | 50 | 2 | 13 | 3 | 29 | 3    | 5 | .9400  | .8500  | .9385  | .7692  |
| 97`   | 2 | 24 | 1 | 17 | 1 | 30 | 5.25 | 5 | 1.0000 | 1.0000 | .8714  | .7857  |
| 98    | 1 | 53 | 3 | 17 | 1 | 16 | 2    | 5 | .9294  | .8824  | .6222  | .4444  |
| 99    | 1 | 51 | 2 | 17 | 1 | 30 | 2.5  | 4 | 1.0000 | 1.0000 | .9792  | .9167  |
| 100   | 1 | 25 | 1 | 17 | 1 | 29 | 2.5  | 5 | .9308  | .8077  | .8353  | .5882  |
| 101   | 1 | 58 | 2 | 16 | 1 | 30 | 2.67 | 4 | 1.0000 | 1.0000 | .9318  | .8636  |
| 102   | 1 | 58 | 2 | 17 | 1 | 30 | 2.5  | 5 | .9200  | .8182  | .9000  | .7143  |
| 103   | 1 | 24 | 1 | 17 | 1 | 30 | 3    | 7 | 1.0000 | 1.0000 | .8564  | .7273  |
| 104   | 1 | 18 | 1 | 12 | 2 | 30 | 5    | 7 | .9829  | .9412  | .7675  | .5000  |
| 105`` | 2 | 67 | 2 | 17 | 1 | 29 | 2.5  | 5 | .8880  | .7600  | .8875  | .7500  |
| 106`  | 1 | 25 | 1 | 16 | 1 | 29 | 2.33 | 5 | .9739  | .9565  | .9200  | .8000  |
| 107`  | 1 | 22 | 1 | 15 | 1 | 30 | 2.7  | 4 | .9741  | .9655  | .9625  | .9000  |
| 108   | 2 | 17 | 1 | 11 | 4 | 29 | 2    | 5 | .9143  | .8095  | .7692  | .5385  |
| 109`  | 2 | 17 | 1 | 9  | 4 | 30 | 4    | 4 | 1.0000 | 1.0000 | .9545  | .9545  |
| 110`  | 1 | 22 | 1 | 16 | 1 | 30 | 2.67 | 5 | .9100  | .7000  | .8000  | .5333  |
| 111   | 1 | 17 | 1 | 11 | 2 | 29 | 3.67 | 5 | .9833  | .9583  | .9778  | .9444  |
| 112   | 2 | 53 | 2 | 17 | 1 | 30 | 3.5  | 5 | .9100  | .8000  | .9600  | .8000  |
| 113   | 1 | 25 | 1 | 17 | 1 | 30 | 3    | 5 | .9583  | .8750  | .9125  | .8125  |
| 114   | 1 | 25 | 1 | 17 | 1 | 29 | 4    | 4 | .9464  | .8929  | .9250  | .8500  |
| 115`` | 2 | 67 | 2 | 16 | 1 | 30 | 2.5  | 6 | .9746  | .9231  | .6673  | .3636  |
| 116   | 1 | 19 | 1 | 14 | 2 | 30 | 3.5  | 7 | .9818  | .9375  | .8171  | .5714  |
| 117`  | 1 | 21 | 1 | 15 | 1 | 30 | 3    | 5 | .9909  | .9545  | .9300  | .8000  |
| 118`  | 1 | 22 | 1 | 16 | 1 | 30 | 3    | 6 | .9113  | .6667  | .7720  | .3636  |
| 119   | 2 | 60 | 2 | 16 | 1 | 29 | 2.67 | 5 | .8947  | .7368  | .6769  | .3846  |
| 120`` | 1 | 58 | 2 | 15 | 1 | 30 | 3    | 6 | 1.0000 | 1.0000 | .9560  | .8667  |
| 121   | 1 | 24 | 1 | 17 | 1 | 30 | 2.5  | 5 | .9600  | .9200  | .9692  | .9231  |
| 122   | 2 | 50 | 2 | 14 | 3 | 28 | 2    | 4 | .9821  | .9643  | .9674  | .8696  |
| 123   | 1 | 17 | 1 | 11 | 4 | 30 | 2.5  | 4 | .9800  | .9600  | 1.0000 | 1.0000 |
| 124   | 1 | 19 | 1 | 13 | 1 | 30 | 2.5  | 4 | .9722  | .9259  | 1.0000 | 1.0000 |
| 125   | 2 | 50 | 2 | 16 | 1 | 30 | 2.67 | 4 | .9891  | .9565  | 1.0000 | 1.0000 |
| 126   | 2 | 73 | 3 | 16 | 1 | 12 | 1    | 4 | .9000  | .8000  | .8594  | .6875  |
| 127   | 2 | 49 | 2 | 16 | 1 | 20 | 3    | 5 | .9368  | .8421  | .8800  | .7333  |
| 128   | 2 | 52 | 2 | 16 | 1 | 29 | 3.67 | 5 | .9818  | .9545  | .8286  | .7143  |
| 129`` | 1 | 59 | 2 | 17 | 1 | 29 | 2.67 | 4 | .9712  | .9231  | .9063  | .7500  |
| 130   | 1 | 54 | 2 | 15 | 1 | 30 | 2.5  | 4 | .9457  | .8696  | .9167  | .8333  |
| 131`  | 1 | 22 | 1 | 16 | 1 | 29 | 3    | 7 | .8187  | .5333  | .7440  | .3333  |
| 132`` | 1 | 70 | 2 | 17 | 1 | 28 | 2.67 | 4 | 1.0000 | 1.0000 | 1.0000 | 1.0000 |
| 133   | 1 | 62 | 2 | 17 | 1 | 30 | 2.5  | 5 | .9368  | .8421  | .8889  | .6667  |
| 134`` | 1 | 67 | 2 | 16 | 1 | 29 | 2    | 4 | .9250  | .8000  | .9231  | .8077  |
| 135   | 1 | 51 | 2 | 16 | 1 | 29 | 2.67 | 5 | .9478  | .8696  | .7733  | .6000  |
| 136`` | 1 | 75 | 2 | 16 | 1 | 28 | 2    | 4 | .9800  | .9600  | .9712  | .9615  |
| 137   | 1 | 66 | 2 | 17 | 1 | 29 | 2.5  | 4 | 1.0000 | 1.0000 | .9783  | .9130  |
| 138`` | 2 | 67 | 3 | 14 | 3 | 17 | 2    | 4 | .9167  | .8571  | .8036  | .7143  |
| 139`  | 1 | 22 | 1 | 16 | 1 | 30 | 3.5  | 5 | .9826  | .9130  | 1.0000 | 1.0000 |
| 140   | 1 | 55 | 2 | 15 | 1 | 28 | 2    | 4 | .9196  | .8214  | .8594  | .7500  |
| 141   | 1 | 58 | 2 | 16 | 1 | 30 | 4    | 6 | .9261  | .7778  | .8457  | .7143  |
| 142`` | 1 | 64 | 2 | 15 | 1 | 28 | 2    | 5 | .8769  | .6154  | .7818  | .6364  |

|        |   |    |   |    |   |    |     |   |       |       |       |       |
|--------|---|----|---|----|---|----|-----|---|-------|-------|-------|-------|
| 143    | 1 | 50 | 2 | 15 | 1 | 30 | 3   | 6 | .9660 | .8000 | .9308 | .8333 |
| 144    | 1 | 62 | 2 | 16 | 1 | 30 | 2.5 | 4 | .9483 | .8966 | .9166 | .8571 |
| 145    | 1 | 25 | 1 | 17 | 1 | 30 | 2.5 | 5 | .8824 | .7059 | .8500 | .6667 |
| 146    | 1 | 72 | 3 | 2  | 4 | 21 | 1   | 3 | .9235 | .8077 | .9890 | .9667 |
| 147''' | 1 | 67 | 3 | 12 | 3 | 22 | 2   | 3 | .9646 | .8929 | .8829 | .7647 |
| 148''' | 1 | 56 | 3 | 16 | 1 | 24 | 2   | 4 | .9750 | .9500 | .9659 | .8636 |

Age code: 1-young participant; 2-elderly participant; 3-patient.

Education code: 1- high education – university; 2- student; 3- professional-technical; 4- School.

Single memory digits - List Memory Task - “digits recalled correctly”.

Single memory lists - List Memory Task - “lists recalled correctly”.

Dual memory comput. digits – Computerised dual-task using List Memory Task - digits recalled correctly.

Dual memory comput. lists - Computerised dual-task using List Memory Task - lists recalled correctly.

Part 2.

|      | Motor tracking single comput. | Motor tracking dual comput. | Dual memory paper digits | Dual memory paper lists | Motor tracking single paper | Motor tracking dual paper | vpa trial 1 | vpa trial 2 | vpa trial 3 | vpa trial 4 | vpa trial delayed |
|------|-------------------------------|-----------------------------|--------------------------|-------------------------|-----------------------------|---------------------------|-------------|-------------|-------------|-------------|-------------------|
| 1''  | 52.908                        | 53.085                      | .7150                    | .3571                   | 184                         | 171                       | 7           | 7           | 8           | 8           | 8                 |
| 2''  | 47.514                        | 48.094                      | .9655                    | .9310                   | 135                         | 152                       | 1           | 2           | 3           | 3           | 1                 |
| 3''  | 44.273                        | 38.645                      | .9677                    | .9355                   | 167                         | 169                       | 0           | 2           | 2           | 2           | 3                 |
| 4''  | 51.066                        | 46.522                      | 1.0000                   | 1.0000                  | 120                         | 145                       | 3           | 5           | 7           | 6           | 7                 |
| 5''  | 51.542                        | 33.699                      |                          |                         |                             |                           | 1           | 2           | 2           | 3           | 0                 |
| 6    | 44.387                        | 45.738                      | .9632                    | .9118                   | 124                         | 114                       | 1           | 5           | 6           | 6           | 6                 |
| 7    | 59.407                        | 64.133                      | .9120                    | .8400                   | 147                         | 150                       | 4           | 5           | 7           | 8           | 7                 |
| 8    | 53.921                        | 56.304                      | 1.0000                   | 1.0000                  | 151                         | 214                       | 0           | 2           | 0           | 0           | 0                 |
| 9''  | 42.280                        | 48.298                      | .9714                    | .9048                   | 141                         | 182                       | 2           | 3           | 5           | 4           | 4                 |
| 10   | 50.161                        | 48.901                      | 1.0000                   | 1.0000                  | 187                         | 198                       | 4           | 5           | 7           | 6           | 7                 |
| 11'  | 61.309                        | 59.684                      | .8168                    | .5263                   | 157                         | 142                       | 6           | 8           | 8           | 8           | 8                 |
| 12'' | 49.197                        | 46.407                      | .9839                    | .9677                   | 123                         | 160                       | 1           | 3           | 6           | 7           | 1                 |
| 13'' | 48.763                        | 35.361                      | .9531                    | .9063                   | 162                         | 180                       | 0           | 2           | 1           | 3           | 0                 |
| 14'' | 52.147                        | 49.445                      | 1.0000                   | 1.0000                  | 175                         | 149                       | 0           | 0           | 2           | 0           | 0                 |
| 15   | 40.810                        | 42.248                      | .9280                    | .8000                   | 183                         | 186                       | 3           | 5           | 7           | 8           | 7                 |
| 16'' | 55.803                        | 61.485                      | 1.0000                   | 1.0000                  | 121                         | 134                       | 1           | 1           | 1           | 1           | 1                 |
| 17   | 53.007                        | 51.787                      | .7092                    | .3333                   | 133                         | 80                        | 0           | 2           | 1           | 2           | 0                 |
| 18   | 51.134                        | 51.241                      | 1.0000                   | 1.0000                  | 172                         | 163                       | 0           | 1           | 2           | 0           | 0                 |
| 19'' | 48.592                        | 49.337                      | .9694                    | .9677                   | 169                         | 165                       | 8           | 8           | 8           | 8           | 8                 |
| 20   | 38.629                        | 33.498                      | .8229                    | .6250                   | 117                         | 101                       | 0           | 2           | 1           | 2           | 5                 |
| 21'' | 51.353                        | 38.420                      | .9565                    | .8696                   | 102                         | 93                        | 0           | 1           | 1           | 3           | 0                 |
| 22   | 48.592                        | 49.337                      | 1.0000                   | 1.0000                  | 181                         | 202                       | 8           | 8           | 8           | 8           | 8                 |
| 23'  | 63.063                        | 64.451                      | .9762                    | .9524                   | 196                         | 195                       | 6           | 8           | 8           | 8           | 8                 |
| 24   | 55.726                        | 66.681                      | .9636                    | .9091                   | 206                         | 204                       | 6           | 8           | 8           | 8           | 8                 |
| 25'  | 47.655                        | 46.271                      | .9688                    | .9375                   | 186                         | 187                       | 2           | 7           | 8           | 8           | 8                 |
| 26   | 58.499                        | 58.728                      | .7580                    | .5263                   | 221                         | 222                       | 3           | 6           | 8           | 8           | 8                 |
| 27   | 49.398                        | 51.021                      |                          |                         |                             |                           | 1           | 3           | 4           | 4           | 2                 |
| 28'  | 55.151                        | 53.542                      | .8978                    | .7778                   | 220                         | 200                       | 2           | 3           | 4           | 8           | 6                 |
| 29'  | 57.299                        | 55.584                      | .9571                    | .8571                   | 212                         | 230                       | 3           | 1           | 1           | 3           | 1                 |
| 30   | 61.401                        | 63.378                      | 1.0000                   | 1.0000                  | 177                         | 187                       | 5           | 7           | 7           | 8           | 6                 |
| 31'' | 50.355                        | 45.576                      | .9043                    | .8261                   | 201                         | 166                       | 1           | 1           | 3           | 4           | 1                 |

|       |        |        |        |        |     |     |   |   |   |   |   |   |
|-------|--------|--------|--------|--------|-----|-----|---|---|---|---|---|---|
| 32''  | 50.716 | 46.039 |        |        |     |     |   |   |   |   |   |   |
| 33''' | 37.411 | 28.561 | .5660  | .3000  | 25  | 18  | 0 | 0 | 0 | 0 | 0 | 0 |
| 34    | 48.410 | 45.169 | .9848  | .9697  | 131 | 115 | 1 | 7 | 8 | 8 | 8 | 7 |
| 35    | 53.282 | 42.723 | .9300  | .8667  | 171 | 180 | 1 | 2 | 4 | 6 | 6 | 5 |
| 36    | 59.924 | 62.572 |        |        |     |     | 1 | 0 | 3 | 2 | 2 | 1 |
| 37    |        |        |        |        |     |     |   |   |   |   |   |   |
| 38    | 52.651 | 43.488 |        |        |     |     | 5 | 8 | 8 | 8 | 8 | 7 |
| 39''' | 33.404 | 18.102 | .9273  | .7727  | 133 | 93  | 0 | 0 | 1 | 0 | 0 | 0 |
| 40    |        |        |        |        |     |     |   |   |   |   |   |   |
| 41    |        |        |        |        |     |     |   |   |   |   |   |   |
| 42'   | 56.560 | 59.731 | .9200  | .8000  | 209 | 172 | 6 | 7 | 8 | 8 | 8 | 8 |
| 43'   | 50.186 | 48.518 | .9653  | .9167  | 182 | 212 | 2 | 6 | 7 | 7 | 8 | 7 |
| 44    | 52.445 | 52.868 | .9467  | .8333  | 175 | 191 | 4 | 6 | 8 | 8 | 8 | 8 |
| 45''  | 49.911 | 49.779 | 1.0000 | 1.0000 | 170 | 166 | 0 | 3 | 0 | 0 | 8 | 7 |
| 46    | 50.920 | 45.443 | .9583  | .8667  | 152 | 168 | 3 | 6 | 8 | 8 | 8 | 8 |
| 47    | 51.936 | 57.244 | 1.0000 | 1.0000 | 194 | 180 | 1 | 1 | 1 | 1 | 3 | 2 |
| 48''' | 52.930 | 56.421 | .9921  | .9762  | 116 | 126 | 0 | 0 | 2 | 0 | 0 | 1 |
| 49''  | 54.255 | 56.856 | .9048  | .7619  | 147 | 137 | 2 | 3 | 5 | 6 | 6 | 5 |
| 50    | 47.583 | 51.864 | .9531  | .8750  | 209 | 204 | 1 | 1 | 4 | 6 | 6 | 5 |
| 51    | 60.722 | 54.490 | .9826  | .9474  | 212 | 195 | 0 | 0 | 1 | 2 | 2 | 1 |
| 52'   | 54.439 | 57.160 | .9500  | .8750  | 133 | 135 | 2 | 4 | 4 | 4 | 7 | 8 |
| 53''' | 50.500 | 40.704 | .8050  | .5000  | 77  | 44  | 0 | 0 | 0 | 0 | 0 | 0 |
| 54    | 54.341 | 36.470 | .7976  | .5556  | 157 | 159 | 0 | 0 | 2 | 3 | 3 | 2 |
| 55    | 44.738 | 38.894 | .8833  | .8000  | 96  | 105 | 0 | 2 | 4 | 6 | 6 | 5 |
| 56    | 50.200 | 49.092 | .9797  | .9459  | 175 | 167 | 7 | 7 | 8 | 8 | 8 | 8 |
| 57''  | 54.755 | 51.213 | .9167  | .8000  | 186 | 105 | 0 | 4 | 4 | 4 | 7 | 5 |
| 58    | 54.584 | 58.046 | .8125  | .6500  | 155 | 152 | 1 | 2 | 2 | 2 | 3 | 1 |
| 59'   | 54.819 | 57.729 | .9167  | .8333  | 194 | 183 | 1 | 4 | 6 | 6 | 8 | 7 |
| 60    | 50.201 | 61.954 | .9794  | .9375  | 187 | 179 | 1 | 2 | 3 | 3 | 4 | 5 |
| 61'   | 45.211 | 47.123 | .9605  | .9048  | 222 | 208 | 5 | 7 | 8 | 8 | 8 | 8 |
| 62    | 51.177 | 59.267 | .8750  | .7667  | 181 | 165 | 3 | 6 | 8 | 8 | 8 | 8 |
| 63'   | 48.659 | 56.828 | .9524  | .8571  | 194 | 186 | 2 | 3 | 4 | 4 | 5 | 3 |
| 64''' | 43.186 | 36.075 | .9444  | .8889  | 69  | 65  | 0 | 0 | 1 | 2 | 2 | 0 |
| 65'   | 76.065 | 74.476 | .8780  | .7222  | 179 | 161 | 3 | 4 | 8 | 8 | 8 | 7 |
| 66''' | 57.963 | 55.290 | .8600  | .7500  | 136 | 106 | 0 | 1 | 3 | 4 | 4 | 4 |
| 67''' | 51.900 | 44.178 | .9554  | .8929  | 94  | 93  | 1 | 1 | 3 | 2 | 2 | 1 |
| 68'   | 57.985 | 57.037 | 1.0000 | 1.0000 | 207 | 215 | 2 | 4 | 8 | 8 | 8 | 8 |
| 69    | 72.716 | 54.166 | .8886  | .8095  | 78  | 57  | 0 | 0 | 0 | 0 | 0 | 0 |
| 70''' | 45.459 | 44.317 | .8875  | .7750  | 121 | 76  | 1 | 1 | 1 | 1 | 1 | 1 |
| 71'   | 45.205 | 43.054 | .9714  | .8571  | 184 | 189 | 3 | 6 | 8 | 8 | 8 | 8 |
| 72    | 48.349 | 45.420 | .9286  | .8571  | 196 | 197 | 2 | 5 | 8 | 8 | 8 | 7 |
| 73    | 48.322 | 38.647 | .9750  | .9167  | 173 | 164 | 1 | 3 | 3 | 3 | 6 | 6 |
| 74''' | 49.116 | 43.051 | .9205  | .8636  | 93  | 67  | 0 | 0 | 1 | 0 | 0 | 0 |
| 75    | 60.648 | 54.739 | .9000  | .7500  | 114 | 133 | 3 | 5 | 6 | 6 | 5 | 6 |
| 76    | 43.030 | 47.757 | .9852  | .9259  | 147 | 150 | 5 | 7 | 8 | 8 | 8 | 8 |
| 77    | 54.263 | 48.871 | .9130  | .8261  | 171 | 139 | 0 | 2 | 6 | 6 | 5 | 2 |
| 78    | 58.827 | 50.431 | .9313  | .6875  | 153 | 152 | 1 | 2 | 5 | 5 | 5 | 5 |
| 79    | 71.792 | 44.638 | .9861  | .9722  | 116 | 130 | 1 | 2 | 4 | 4 | 7 | 5 |
| 80    | 52.180 | 48.138 | .9471  | .7143  | 167 | 151 | 1 | 3 | 5 | 5 | 5 | 5 |
| 81    | 43.544 | 39.233 | .8640  | .6800  | 227 | 221 | 5 | 7 | 8 | 8 | 8 | 7 |
| 82    | 75.074 | 42.673 | .9878  | .9512  | 197 | 213 | 2 | 3 | 4 | 4 | 5 | 4 |
| 83    | 43.605 | 42.673 | .9793  | .9310  | 186 | 198 | 2 | 4 | 4 | 4 | 7 | 4 |
| 84    | 49.586 | 49.457 | .9038  | .8077  | 200 | 165 | 0 | 1 | 1 | 1 | 1 | 2 |
| 85    | 47.112 | 56.451 | 1.0000 | 1.0000 | 185 | 166 | 1 | 1 | 4 | 6 | 6 | 3 |
| 86    | 55.389 | 57.847 | .9737  | .8947  | 189 | 166 | 6 | 8 | 8 | 8 | 8 | 8 |
| 87'   | 68.555 | 60.660 | .9167  | .7917  | 181 | 173 | 5 | 4 | 6 | 6 | 7 | 7 |
| 88'   | 58.706 | 51.613 | .7920  | .5600  | 195 | 219 | 1 | 7 | 8 | 8 | 8 | 8 |
| 89'   | 50.801 | 54.157 | .9130  | .8261  | 241 | 209 | 2 | 3 | 6 | 6 | 5 | 6 |

|        |        |        |        |        |     |     |   |    |    |    |   |
|--------|--------|--------|--------|--------|-----|-----|---|----|----|----|---|
| 90     | 47.643 | 45.999 | .9241  | .7647  | 211 | 231 | 2 | 1  | 2  | 5  | 3 |
| 91     | 45.005 | 54.708 | .8811  | .6667  | 239 | 254 | 7 | 10 | 11 | 12 | 9 |
| 92'''  | 66.508 | 58.101 | .7900  | .4500  | 95  | 85  | 0 | 1  | 1  | 0  | 0 |
| 93     | 61.728 | 48.904 | .9220  | .8667  | 70  | 39  | 0 | 0  | 0  | 0  | 0 |
| 94     | 48.135 | 42.931 | .9500  | .9167  | 190 | 189 | 1 | 5  | 6  | 8  | 8 |
| 95''   | 44.788 | 44.334 | .9857  | .9565  | 160 | 159 | 3 | 2  | 4  | 4  | 3 |
| 96     | 50.732 | 52.155 | .9200  | .7500  | 206 | 180 | 3 | 5  | 6  | 6  | 4 |
| 97`    | 51.151 | 45.488 | .9867  | .9667  | 228 | 240 | 4 | 4  | 8  | 8  | 7 |
| 98     | 46.387 | 18.492 | .8533  | .6667  | 62  | 21  | 0 | 2  | 2  | 2  | 0 |
| 99     | 53.986 | 40.586 | .9844  | .9688  | 159 | 153 | 1 | 3  | 6  | 5  | 4 |
| 100    | 47.032 | 40.888 | .9333  | .8333  | 176 | 164 | 2 | 5  | 7  | 7  | 6 |
| 101    | 42.170 | 36.134 | .9375  | .8750  | 172 | 158 | 1 | 1  | 2  | 4  | 2 |
| 102    | 83.867 | 78.554 | .9430  | .8571  | 159 | 155 | 4 | 6  | 8  | 8  | 6 |
| 103    | 53.735 | 60.909 | .8271  | .6429  | 203 | 190 | 0 | 3  | 7  | 8  | 8 |
| 104    | 61.449 | 63.844 | .8953  | .6667  | 152 | 167 | 2 | 5  | 5  | 8  | 8 |
| 105''  | 42.100 | 39.090 | .8963  | .8148  | 182 | 146 | 0 | 3  | 3  | 1  | 2 |
| 106`   | 54.273 | 49.549 | .8727  | .6818  | 192 | 172 | 1 | 2  | 6  | 8  | 5 |
| 107`   | 66.584 | 56.725 | .9828  | .9655  | 191 | 189 | 0 | 0  | 4  | 8  | 7 |
| 108    | 46.513 | 45.028 | .8900  | .7000  | 177 | 168 | 2 | 5  | 5  | 7  | 7 |
| 109`   | 64.728 | 62.490 | 1.0000 | 1.0000 | 187 | 159 | 5 | 7  | 8  | 8  | 6 |
| 110`   | 58.638 | 49.327 | .9565  | .8696  | 176 | 165 | 4 | 7  | 6  | 7  | 7 |
| 111    | 58.884 | 69.687 | .9500  | .8750  | 212 | 229 | 0 | 3  | 2  | 2  | 1 |
| 112    | 55.649 | 62.314 | .9739  | .9130  | 171 | 169 | 0 | 0  | 5  | 8  | 8 |
| 113    | 49.751 | 51.298 | .9667  | .9583  | 212 | 190 | 1 | 2  | 2  | 1  | 0 |
| 114    | 56.209 | 52.586 | .9397  | .8621  | 215 | 181 | 1 | 3  | 2  | 6  | 3 |
| 115''  | 48.805 | 45.091 | .9050  | .7143  | 127 | 141 | 1 | 0  | 2  | 2  | 1 |
| 116    | 65.699 | 66.433 | .9115  | .6154  | 185 | 148 | 8 | 8  | 8  | 8  | 8 |
| 117`   | 52.824 | 56.513 | .9091  | .8182  | 213 | 212 | 7 | 7  | 7  | 7  | 6 |
| 118`   | 50.658 | 48.683 | .7680  | .4000  | 182 | 112 | 0 | 1  | 2  | 5  | 4 |
| 119    | 52.335 | 49.673 | .9053  | .6842  | 135 | 112 | 5 | 7  | 8  | 8  | 8 |
| 120''  | 49.330 | 48.997 | .9300  | .7895  | 152 | 176 | 0 | 0  | 1  | 3  | 3 |
| 121    | 49.691 | 47.082 | 1.0000 | 1.0000 | 170 | 169 | 7 | 8  | 8  | 8  | 8 |
| 122    | 57.140 | 53.288 | .9643  | .9286  | 146 | 159 | 0 | 1  | 0  | 0  | 0 |
| 123    | 44.877 | 57.807 | .9167  | .8333  | 163 | 137 | 0 | 2  | 5  | 5  | 4 |
| 124    | 40.344 | 42.472 | .9667  | .9333  | 109 | 135 | 4 | 8  | 6  | 8  | 8 |
| 125    | 60.077 | 65.293 | .9531  | .8750  | 170 | 171 | 1 | 3  | 3  | 4  | 4 |
| 126    | 35.586 | 23.461 | .5500  | .1000  | 20  | 11  | 0 | 0  | 0  | 0  | 0 |
| 127    | 56.451 | 44.093 | .8588  | .6471  | 227 | 176 | 2 | 6  | 8  | 8  | 8 |
| 128    | 51.239 | 50.968 | .9826  | .9565  | 197 | 204 | 4 | 7  | 8  | 8  | 8 |
| 129''  | 54.553 | 42.859 | .9318  | .8636  | 130 | 122 | 4 | 6  | 8  | 8  | 8 |
| 130    | 51.902 | 49.927 | .8966  | .7586  | 118 | 131 | 3 | 5  | 3  | 6  | 4 |
| 131`   | 49.160 | 65.921 | .8660  | .6000  | 180 | 187 | 1 | 4  | 4  | 2  | 4 |
| 132''  | 42.822 | 45.077 | 1.0000 | 1.0000 | 136 | 123 | 1 | 3  | 3  | 3  | 1 |
| 133    | 63.326 | 64.243 | .8947  | .7895  | 115 | 133 | 0 | 4  | 5  | 7  | 6 |
| 134''  | 58.182 | 52.829 | .9397  | .8621  | 164 | 153 | 2 | 4  | 3  | 5  | 4 |
| 135    | 47.454 | 47.858 | 1.0000 | 1.0000 | 128 | 132 | 2 | 3  | 6  | 6  | 3 |
| 136''  | 50.557 | 46.545 | 1.0000 | 1.0000 | 150 | 83  | 2 | 3  | 3  | 4  | 3 |
| 137    | 56.713 | 58.472 | .9712  | .8846  | 148 | 129 | 0 | 0  | 0  | 0  | 0 |
| 138''' | 52.712 | 36.804 | .9750  | .9500  | 121 | 84  | 0 | 0  | 0  | 0  | 0 |
| 139`   | 58.981 | 60.515 | .9417  | .8333  | 193 | 199 | 5 | 6  | 8  | 8  | 8 |
| 140    | 63.351 | 46.209 | .8833  | .8000  | 175 | 128 | 2 | 2  | 2  | 2  | 2 |
| 141    | 53.888 | 34.855 | .8624  | .7647  | 174 | 142 | 6 | 8  | 8  | 8  | 7 |
| 142''  | 56.036 | 54.632 | .8000  | .5385  | 75  | 78  | 2 | 0  | 3  | 2  | 0 |
| 143    | 46.167 | 52.829 | .8047  | .6471  | 181 | 192 | 1 | 6  | 8  | 8  | 8 |
| 144    | 54.579 | 53.672 | .9274  | .8387  | 154 | 135 | 4 | 4  | 5  | 5  | 6 |
| 145    | 54.865 | 50.983 | .9474  | .8421  | 178 | 186 | 4 | 7  | 7  | 7  | 8 |
| 146    | 46.574 | 50.281 | .9550  | .8636  | 26  | 32  | 0 | 1  | 1  | 1  | 1 |
| 147''' | 45.777 | 33.748 | .7189  | .5789  | 67  | 51  | 0 | 0  | 0  | 0  | 0 |

|        |        |        |       |       |     |     |   |   |   |   |   |
|--------|--------|--------|-------|-------|-----|-----|---|---|---|---|---|
| 148''' | 56.201 | 56.624 | .9405 | .8571 | 135 | 111 | 0 | 1 | 1 | 1 | 0 |
|--------|--------|--------|-------|-------|-----|-----|---|---|---|---|---|

Dual memory paper digits – Paper and pencil dual-task using List Memory Task - digits recalled correctly.

Dual memory paper lists - Paper and pencil dual-task using List Memory Task - lists recalled correctly.

VPA trial 1-4 and VPA trial delayed – Verbal Paired Associates trials 1-4 and delayed correspondingly.

Part 3.

|       | WLL trial 1 | WLL trial 2 | WLL trial 3 | WLL trial 4 | WLL trial delayed | Percent. change comput. digits | Percent. change comput. lists | Percent. change comput. motor | Percent. change paper digits | Percent. change paper lists | Percent. change paper motor |
|-------|-------------|-------------|-------------|-------------|-------------------|--------------------------------|-------------------------------|-------------------------------|------------------------------|-----------------------------|-----------------------------|
| 1''   | 6           | 6           | 11          | 11          | 6                 | .00                            | 25.00                         | -.33                          | 8.68                         | 10.71                       | 7.07                        |
| 2''   | 5           | 6           | 6           | 8           | 6                 | -6.07                          | -4.17                         | -1.22                         | -5.33                        | -16.38                      | -12.59                      |
| 3''   | 5           | 8           | 10          | 9           | 3                 | -1.40                          | 17.58                         | 12.71                         | -15.45                       | -44.57                      | -1.20                       |
| 4''   | 6           | 7           | 8           | 9           | 6                 | -23.72                         | -92.00                        | 8.90                          | -39.54                       | -140.00                     | -20.83                      |
| 5''   | 3           | 5           | 8           | 8           | 0                 | -3.19                          |                               | 34.62                         |                              |                             |                             |
| 6     | 7           | 11          | 11          | 12          | 12                | -11.77                         | -15.71                        | -3.04                         | -11.86                       | -17.23                      | 8.06                        |
| 7     | 8           | 10          | 12          | 12          | 6                 | 21.84                          | 67.69                         | -7.96                         | -2.97                        | -17.60                      | -2.04                       |
| 8     | 4           | 5           | 8           | 9           | 4                 | -3.28                          | -21.43                        | -4.42                         | -17.24                       | -70.00                      | -41.72                      |
| 9''   | 2           | 5           | 6           | 9           | 4                 | 8.85                           | 25.96                         | -14.23                        | -1.19                        | 2.56                        | -29.08                      |
| 10    | 4           | 7           | 10          | 10          | 5                 | -3.63                          | -7.42                         | 2.51                          | -9.59                        | -17.65                      | -5.88                       |
| 11'   | 11          | 12          | 12          | 12          | 12                | 20.11                          | 50.00                         | 2.65                          | 9.58                         | 21.05                       | 9.55                        |
| 12''  | 5           | 8           | 8           | 10          | 0                 | 1.49                           | 8.93                          | 5.67                          | -5.73                        | -8.87                       | -30.08                      |
| 13''  | 4           | 7           | 8           | 9           | 6                 | -6.13                          | -15.91                        | 27.48                         | -7.90                        | -23.58                      | -11.11                      |
| 14''  | 3           | 7           | 7           | 8           | 5                 | 15.91                          | 29.41                         | 5.18                          | -5.89                        | -20.00                      | 14.86                       |
| 15    | 6           | 8           | 10          | 11          | 11                | -5.00                          | -46.67                        | -3.52                         | -16.00                       | -60.00                      | -1.64                       |
| 16''  | 7           | 7           | 9           | 10          | 6                 | .00                            | .00                           | -10.18                        | .00                          | .00                         | -10.74                      |
| 17    | 4           | 4           | 7           | 6           | 0                 | 29.47                          | 50.41                         | 2.30                          | 25.35                        | 63.64                       | 39.85                       |
| 18    | 3           | 5           | 5           | 7           | 2                 | -1.11                          | -9.09                         | -.21                          | -5.93                        | -20.00                      | 5.23                        |
| 19''  | 10          | 12          | 12          | 12          | 11                | -9.89                          | 4.20                          | -1.53                         | -6.53                        | -8.16                       | 2.37                        |
| 20    | 4           | 9           | 9           | 10          | 6                 | .00                            | 1.23                          | 13.28                         | .86                          | -11.11                      | 13.68                       |
| 21''  | 5           | 7           | 10          | 11          | 1                 | 7.06                           | 38.10                         | 25.18                         | -12.53                       | -25.60                      | 8.82                        |
| 22    | 10          | 12          | 12          | 12          | 11                | -9.89                          | -40.00                        | -1.53                         | -9.89                        | -40.00                      | -11.60                      |
| 23'   | 12          | 12          | 12          | 12          | 12                | 15.00                          | 38.46                         | -2.20                         | 2.38                         | 4.76                        | .51                         |
| 24    | 6           | 10          | 11          | 12          | 12                | 24.21                          | 46.15                         | -19.66                        | -1.43                        | -4.90                       | .97                         |
| 25'   | 7           | 9           | 11          | 12          | 8                 | -11.84                         | -21.43                        | 2.90                          | -8.35                        | -13.84                      | -.54                        |
| 26    | 6           | 8           | 10          | 12          | 11                | -1.47                          | -18.95                        | -.39                          | 5.25                         | 18.13                       | -.45                        |
| 27    | 7           | 8           | 8           | 8           | 7                 | -21.15                         |                               | -3.29                         |                              |                             |                             |
| 28'   | 5           | 10          | 12          | 11          | 8                 | -7.69                          | -5.77                         | 2.92                          | -7.70                        | -6.94                       | 9.09                        |
| 29'   | 8           | 11          | 9           | 11          | 10                | 5.08                           | 19.79                         | 2.99                          | -8.76                        | -16.88                      | -8.49                       |
| 30    | 8           | 9           | 12          | 12          | 11                | .90                            | -.59                          | -3.22                         | -1.12                        | -5.88                       | -5.65                       |
| 31''  | 7           | 7           | 10          | 11          | 7                 | 1.02                           | 1.01                          | 9.49                          | 4.09                         | -5.14                       | 17.41                       |
| 32''  |             |             |             |             |                   | -4.41                          |                               | 9.22                          |                              |                             |                             |
| 33''' | 2           | 2           | 2           | 1           | 0                 | -2.52                          | 5.88                          | 23.66                         | 20.00                        | 46.67                       | 28.00                       |
| 34    | 8           | 11          | 12          | 12          | 11                | 7.09                           | 20.31                         | 6.69                          | -5.82                        | -9.09                       | 12.21                       |
| 35    | 7           | 11          | 12          | 12          | 10                | 10.06                          | 10.71                         | 19.82                         | -3.33                        | -8.33                       | -5.26                       |
| 36    | 4           | 7           | 8           | 9           | 8                 | 18.99                          |                               | -4.42                         |                              |                             |                             |
| 37    |             |             |             |             |                   |                                |                               |                               |                              |                             |                             |
| 38    | 6           | 8           | 11          | 11          | 9                 | -4.02                          |                               | 17.40                         |                              |                             |                             |



|       |    |    |    |    |    |        |        |        |        |        |        |
|-------|----|----|----|----|----|--------|--------|--------|--------|--------|--------|
| 39''' | 3  | 6  | 5  | 4  | 0  | 3.56   | 12.65  | 45.81  | 3.56   | 12.65  | 30.08  |
| 40    |    |    |    |    |    |        |        |        |        |        |        |
| 41    |    |    |    |    |    |        |        |        |        |        |        |
| 42`   | 8  | 10 | 12 | 11 | 11 | -7.42  | -12.50 | -5.61  | -19.26 | -40.00 | 17.70  |
| 43`   | 6  | 12 | 10 | 12 | 10 | 2.01   | 3.74   | 3.32   | -.29   | -7.84  | -16.48 |
| 44    | 6  | 8  | 11 | 10 | 6  | -.50   | -1.19  | -.81   | -3.17  | -1.19  | -9.14  |
| 45''' | 8  | 9  | 9  | 10 | 6  | 1.93   | 3.85   | .26    | .00    | .00    | 2.35   |
| 46    | 6  | 10 | 11 | 12 | 8  | -.13   | 2.12   | 10.76  | -5.55  | -9.78  | -10.53 |
| 47    | 4  | 8  | 9  | 11 | 7  | 1.00   | -.84   | -10.22 | -1.41  | -5.88  | 7.22   |
| 48''' | 0  | 3  | 5  | 4  | 0  | 11.49  | 15.89  | -6.60  | -.25   | -.77   | -8.62  |
| 49''' | 1  | 8  | 9  | 10 | 6  | .00    | 5.77   | -4.79  | -4.40  | -23.08 | 6.80   |
| 50    | 8  | 10 | 10 | 10 | 10 | 26.10  | 44.23  | -9.00  | -1.44  | 2.40   | 2.39   |
| 51    | 5  | 6  | 7  | 7  | 2  | 44.48  | 71.21  | 10.26  | .00    | .00    | 8.02   |
| 52`   | 7  | 9  | 10 | 12 | 12 | 10.43  | 32.50  | -5.00  | 1.34   | 5.50   | -1.50  |
| 53''' | 1  | 3  | 2  | 1  | 0  | 21.85  | 48.72  | 19.40  | 5.78   | 16.67  | 42.86  |
| 54    | 2  | 5  | 6  | 5  | 4  | 6.45   | 31.20  | 32.89  | 9.00   | 29.01  | -1.27  |
| 55    | 0  | 5  | 5  | 8  | 5  | 41.74  | 77.04  | 13.06  | 7.02   | 14.29  | -9.38  |
| 56    | 5  | 8  | 8  | 9  | 6  | .70    | 2.86   | 2.21   | -5.74  | -14.86 | 4.57   |
| 57''' | 5  | 11 | 11 | 12 | 10 | -2.73  | -6.18  | 6.47   | -2.24  | -.87   | 43.55  |
| 58    | 6  | 11 | 8  | 9  | 8  | .46    | 4.90   | -6.34  | 6.35   | 15.00  | 1.94   |
| 59`   | 9  | 11 | 12 | 12 | 11 | -13.20 | 6.67   | -5.31  | -36.54 | -66.67 | 5.67   |
| 60    | 6  | 9  | 11 | 11 | 10 | -25.36 | -84.62 | -23.41 | -27.69 | -87.50 | 4.28   |
| 61`   | 11 | 12 | 12 | 12 | 12 | 18.08  | 41.67  | -4.23  | 3.95   | 9.52   | 6.31   |
| 62    | 4  | 7  | 8  | 12 | 8  | 4.35   | 8.70   | -15.81 | 12.50  | 23.33  | 8.84   |
| 63`   | 5  | 6  | 7  | 9  | 3  | 7.66   | 6.11   | -16.79 | 3.50   | 7.14   | 4.12   |
| 64''' | 2  | 3  | 4  | 5  | 0  | -1.59  | -2.98  | 16.47  | .53    | 2.22   | 5.80   |
| 65`   | 5  | 11 | 11 | 12 | 10 | -8.75  | -30.00 | 2.09   | -3.78  | -17.36 | 10.06  |
| 66''' | 4  | 5  | 6  | 7  | 0  | 2.97   | 2.78   | 4.61   | 10.59  | 12.50  | 22.06  |
| 67''' | 2  | 4  | 6  | 6  | 0  | 13.61  | 20.91  | 14.88  | 3.16   | -3.57  | 1.06   |
| 68`   | 11 | 12 | 12 | 12 | 12 | 5.15   | 15.38  | 1.63   | .00    | .00    | -3.86  |
| 69    | 0  | 3  | 3  | 4  | 0  | -1.17  | 1.58   | 25.51  | 5.42   | 6.27   | 26.92  |
| 70''' | 2  | 2  | 2  | 3  | 0  | 2.20   | 4.99   | 2.51   | .49    | 1.12   | 37.19  |
| 71`   | 4  | 9  | 12 | 12 | 10 | 15.67  | 28.11  | 4.76   | 1.40   | 10.99  | -2.72  |
| 72    | 5  | 8  | 9  | 10 | 5  | -2.14  | -10.00 | 6.06   | 1.67   | -2.86  | -.51   |
| 73    | 5  | 8  | 11 | 12 | 8  | 20.12  | 42.50  | 20.02  | -2.87  | -5.42  | 5.20   |
| 74''' | 2  | 3  | 3  | 2  | 0  | 7.56   | 18.37  | 12.35  | 3.42   | 1.30   | 27.96  |
| 75    | 7  | 9  | 10 | 12 | 7  | 11.59  | 27.94  | 9.74   | 2.58   | 7.35   | -16.67 |
| 76    | 8  | 11 | 12 | 12 | 12 | -5.23  | -5.49  | -10.99 | -18.23 | -58.73 | -2.04  |
| 77    | 1  | 6  | 8  | 8  | 1  | 6.04   | 7.69   | 9.94   | 2.18   | .87    | 18.71  |
| 78    | 6  | 12 | 11 | 12 | 12 | 7.06   | 25.00  | 14.27  | 1.21   | -3.13  | .65    |
| 79    | 6  | 7  | 8  | 11 | 7  | 2.38   | 9.52   | 37.82  | 1.39   | 2.78   | -12.07 |
| 80    | 7  | 7  | 11 | 12 | 12 | -3.63  | 10.95  | 7.75   | -1.39  | 13.27  | 9.58   |
| 81    | 5  | 9  | 12 | 12 | 10 | 5.07   | 23.33  | 9.90   | 5.37   | 2.25   | 2.64   |
| 82    | 4  | 7  | 11 | 10 | 9  | -1.37  | -2.78  | 43.16  | -.13   | 2.24   | -8.12  |
| 83    | 5  | 8  | 10 | 12 | 8  | 4.62   | 12.15  | 2.14   | -8.29  | -18.97 | -6.45  |
| 84    | 7  | 9  | 10 | 10 | 5  | -2.25  | -4.36  | .26    | 2.02   | 2.40   | 17.50  |
| 85    | 4  | 8  | 9  | 10 | 5  | 9.54   | 20.31  | -19.82 | -.77   | -3.13  | 10.27  |
| 86    | 7  | 10 | 12 | 12 | 11 | 4.88   | 10.00  | -4.44  | .26    | 6.05   | 12.17  |
| 87`   | 5  | 10 | 10 | 11 | 10 | 10.03  | 12.28  | 11.52  | -1.40  | -4.17  | 4.42   |
| 88`   | 9  | 12 | 12 | 12 | 11 | 15.15  | 31.37  | 12.08  | 10.00  | 17.65  | -12.31 |
| 89`   | 7  | 9  | 11 | 12 | 10 | 1.07   | -6.21  | -6.61  | -3.75  | -14.73 | 13.28  |
| 90    | 5  | 9  | 12 | 12 | 11 | 3.93   | 19.05  | 3.45   | 1.82   | 7.14   | -9.48  |
| 91    | 5  | 7  | 8  | 8  | 8  | 22.33  | 41.56  | -21.56 | 7.53   | 14.29  | -6.28  |
| 92''' | 2  | 4  | 6  | 4  | 0  | 11.11  | 46.67  | 12.64  | 7.06   | 28.00  | 10.53  |
| 93    | 2  | 2  | 2  | 1  | 0  | .43    | -8.42  | 20.78  | 4.09   | .95    | 44.29  |
| 94    | 6  | 8  | 9  | 10 | 10 | -1.12  | -3.85  | 10.81  | -12.08 | -48.08 | .53    |
| 95''' | 4  | 4  | 5  | 7  | 2  | 8.73   | 17.65  | 1.01   | -6.15  | -18.16 | .63    |
| 96    | 6  | 8  | 9  | 9  | 6  | .16    | 9.50   | -2.80  | 2.13   | 11.76  | 12.62  |

|       |    |    |    |    |    |       |        |        |       |        |        |
|-------|----|----|----|----|----|-------|--------|--------|-------|--------|--------|
| 97`   | 7  | 10 | 11 | 12 | 9  | 12.86 | 21.43  | 11.07  | 1.33  | 3.33   | -5.26  |
| 98    | 3  | 7  | 4  | 6  | 0  | 33.05 | 49.63  | 60.14  | 8.19  | 24.44  | 66.13  |
| 99    | 5  | 9  | 10 | 10 | 6  | 2.08  | 8.33   | 24.82  | 1.56  | 3.13   | 3.77   |
| 100   | 6  | 10 | 10 | 12 | 10 | 10.26 | 27.17  | 13.06  | -.27  | -3.17  | 6.82   |
| 101   | 4  | 8  | 9  | 12 | 9  | 6.82  | 13.64  | 14.31  | 6.25  | 12.50  | 8.14   |
| 102   | 7  | 10 | 12 | 12 | 12 | 2.17  | 12.70  | 6.34   | -2.50 | -4.76  | 2.52   |
| 103   | 11 | 12 | 12 | 12 | 12 | 14.36 | 27.27  | -13.35 | 17.29 | 35.71  | 6.40   |
| 104   | 6  | 10 | 10 | 12 | 11 | 21.91 | 46.88  | -3.90  | 8.91  | 29.17  | -9.87  |
| 105`` | 5  | 8  | 11 | 12 | 5  | .06   | 1.32   | 7.15   | -.93  | -7.21  | 19.78  |
| 106`  | 3  | 7  | 8  | 11 | 4  | 5.53  | 16.36  | 8.70   | 10.39 | 28.72  | 10.42  |
| 107`  | 9  | 12 | 12 | 12 | 12 | 1.19  | 6.79   | 14.81  | -.89  | .00    | 1.05   |
| 108   | 6  | 10 | 11 | 12 | 10 | 15.87 | 33.48  | 3.19   | 2.66  | 13.53  | 5.08   |
| 109`  | 9  | 10 | 11 | 12 | 10 | 4.55  | 4.55   | 3.46   | .00   | .00    | 14.97  |
| 110`  | 7  | 11 | 12 | 12 | 10 | 12.09 | 23.81  | 15.88  | -5.11 | -24.22 | 6.25   |
| 111   | 5  | 7  | 11 | 12 | 11 | .56   | 1.45   | -18.35 | 3.39  | 8.70   | -8.02  |
| 112   | 4  | 8  | 11 | 12 | 7  | -5.49 | .00    | -11.98 | -7.02 | -14.13 | 1.17   |
| 113   | 7  | 8  | 10 | 12 | 9  | 4.78  | 7.14   | -3.11  | -.88  | -9.52  | 10.38  |
| 114   | 6  | 7  | 8  | 8  | 7  | 2.26  | 4.80   | 6.45   | .71   | 3.45   | 15.81  |
| 115`` | 5  | 5  | 7  | 9  | 5  | 31.53 | 60.61  | 7.61   | 7.14  | 22.62  | -11.02 |
| 116   | 7  | 8  | 10 | 12 | 11 | 16.78 | 39.05  | -1.12  | 7.16  | 34.36  | 20.00  |
| 117`  | 7  | 9  | 10 | 11 | 5  | 6.15  | 16.19  | -6.98  | 8.26  | 14.29  | .47    |
| 118`  | 9  | 11 | 11 | 12 | 12 | 15.29 | 45.45  | 3.90   | 15.72 | 40.00  | 38.46  |
| 119   | 5  | 9  | 11 | 12 | 12 | 24.34 | 47.80  | 5.09   | -1.18 | 7.14   | 17.04  |
| 120`` | 4  | 9  | 7  | 11 | 5  | 4.40  | 13.33  | .68    | 7.00  | 21.05  | -15.79 |
| 121   | 10 | 12 | 12 | 12 | 12 | -.96  | -.33   | 5.25   | -4.17 | -8.70  | .59    |
| 122   | 2  | 4  | 8  | 10 | 6  | 1.50  | 9.82   | 6.74   | 1.81  | 3.70   | -8.90  |
| 123   | 6  | 9  | 11 | 12 | 12 | -2.04 | -4.17  | -28.81 | 6.46  | 13.19  | 15.95  |
| 124   | 7  | 9  | 12 | 12 | 10 | -2.86 | -8.00  | -5.27  | .57   | -.80   | -23.85 |
| 125   | 5  | 7  | 8  | 9  | 7  | -1.10 | -4.55  | -8.68  | 3.64  | 8.52   | -.59   |
| 126   | 1  | 1  | 0  | 0  | 0  | 4.51  | 14.06  | 34.07  | 38.89 | 87.50  | 45.00  |
| 127   | 7  | 10 | 9  | 12 | 9  | 6.06  | 12.92  | 21.89  | 8.33  | 23.16  | 22.47  |
| 128   | 8  | 11 | 10 | 12 | 12 | 15.60 | 25.17  | .53    | -.08  | -.21   | -3.55  |
| 129`` | 5  | 8  | 11 | 10 | 12 | 6.68  | 18.75  | 21.44  | 4.06  | 6.44   | 6.15   |
| 130   | 4  | 7  | 10 | 9  | 5  | 3.07  | 4.17   | 3.81   | 5.19  | 12.76  | -11.02 |
| 131`  | 9  | 9  | 10 | 12 | 8  | 9.12  | 37.50  | -34.09 | -5.78 | -12.50 | -3.89  |
| 132`` | 4  | 4  | 7  | 8  | 0  | .00   | .00    | -5.27  | .00   | .00    | 9.56   |
| 133   | 7  | 9  | 11 | 10 | 7  | 5.11  | 20.83  | -1.45  | 4.49  | 6.25   | -15.65 |
| 134`` | 5  | 9  | 12 | 12 | 10 | .21   | -.96   | 9.20   | -1.59 | -7.76  | 6.71   |
| 135   | 5  | 8  | 11 | 12 | 8  | 18.41 | 31.00  | -.85   | -5.51 | -15.00 | -3.13  |
| 136`` | 4  | 5  | 6  | 9  | 0  | .90   | -.16   | 7.94   | -2.04 | -4.17  | 44.67  |
| 137   | 3  | 5  | 5  | 7  | 0  | 2.17  | 8.70   | -3.10  | 2.88  | 11.54  | 12.84  |
| 138`` | 0  | 3  | 4  | 4  | 2  | 12.34 | 16.67  | 30.18  | -6.36 | -10.83 | 30.58  |
| 139`  | 5  | 10 | 11 | 10 | 10 | -1.77 | -9.52  | -2.60  | 4.16  | 8.73   | -3.11  |
| 140   | 4  | 4  | 5  | 6  | 2  | 6.55  | 8.70   | 27.06  | 3.95  | 2.61   | 26.86  |
| 141   | 7  | 9  | 12 | 12 | 7  | 8.68  | 8.16   | 35.32  | 6.88  | 1.68   | 18.39  |
| 142`` | 5  | 9  | 8  | 7  | 4  | 10.85 | -3.41  | 2.51   | 8.77  | 12.50  | -4.00  |
| 143   | 8  | 9  | 12 | 12 | 12 | 3.64  | -4.17  | -14.43 | 16.70 | 19.12  | -6.08  |
| 144   | 3  | 9  | 8  | 9  | 3  | 3.34  | 4.40   | 1.66   | 2.20  | 6.45   | 12.34  |
| 145   | 6  | 9  | 12 | 12 | 12 | 3.67  | 5.56   | 7.08   | -7.37 | -19.30 | -4.49  |
| 146   | 0  | 5  | 4  | 4  | 3  | -7.09 | -19.68 | -7.96  | -3.41 | -6.93  | -23.08 |
| 147`` | 3  | 3  | 4  | 7  | 0  | 8.47  | 14.35  | 26.28  | 25.47 | 35.16  | 23.88  |
| 148`` | 3  | 4  | 5  | 5  | 1  | .93   | 9.09   | -.75   | 3.54  | 9.77   | 17.78  |

WLL trial 1-4 and VPA trial delayed – Word Lists Learning trials 1-4 and delayed correspondingly.

Part 4.

|       | <i>mu</i><br>comput<br>digits | <i>mu</i><br>comput<br>lists | <i>mu</i><br>paper<br>digits | <i>mu</i><br>paper<br>lists | Learn.<br>Slope<br>VPA | Learn.<br>Slope<br>WLL | Episodic<br>VPA | Episodic<br>WLL |
|-------|-------------------------------|------------------------------|------------------------------|-----------------------------|------------------------|------------------------|-----------------|-----------------|
| 1''   | 100.17                        | 87.67                        | 92.13                        | 91.11                       | 1                      | 5                      | 100             | 54.55           |
| 2''   | 103.64                        | 102.69                       | 108.96                       | 114.49                      | 2                      | 3                      | 33              | 75              |
| 3''   | 94.35                         | 84.86                        | 108.32                       | 122.89                      | 2                      | 4                      | 100             | 33.33           |
| 4''   | 107.41                        | 141.55                       | 130.18                       | 180.42                      | 3                      | 3                      | 100             | 66.67           |
| 5''   | 84.29                         |                              |                              |                             | 2                      | 5                      | 0               | 0               |
| 6     | 107.41                        | 109.38                       | 101.90                       | 104.58                      | 5                      | 5                      | 100             | 100             |
| 7     | 93.06                         | 70.13                        | 102.50                       | 109.82                      | 4                      | 4                      | 87.50           | 50              |
| 8     | 103.85                        | 112.92                       | 129.48                       | 155.86                      | 0                      | 5                      | 0               | 44.44           |
| 9''   | 102.69                        | 94.14                        | 115.13                       | 113.26                      | 2                      | 7                      | 100             | 44.44           |
| 10    | 100.56                        | 102.45                       | 107.74                       | 111.76                      | 2                      | 6                      | 100             | 50              |
| 11'   | 88.62                         | 73.67                        | 90.43                        | 84.70                       | 2                      | 1                      | 100             | 100             |
| 12''  | 96.42                         | 92.70                        | 117.91                       | 119.48                      | 6                      | 5                      | 14.29           | 0               |
| 13''  | 89.32                         | 94.21                        | 109.50                       | 117.35                      | 3                      | 5                      | 0               | 66.67           |
| 14''  | 89.45                         | 82.70                        | 95.52                        | 102.57                      | 0                      | 5                      | 0               | 62.50           |
| 15    | 104.26                        | 125.10                       | 108.82                       | 130.82                      | 5                      | 5                      | 87.50           | 100             |
| 16''  | 105.09                        | 105.09                       | 105.37                       | 105.37                      | 0                      | 3                      | 100             | 60              |
| 17    | 84.11                         | 73.64                        | 67.40                        | 48.26                       | 2                      | 2                      | 0               | 0               |
| 18    | 100.66                        | 104.65                       | 100.35                       | 107.38                      | 0                      | 4                      | 0               | 28.57           |
| 19''  | 105.71                        | 98.67                        | 102.08                       | 102.90                      | 0                      | 2                      | 100             | 91.67           |
| 20    | 93.36                         | 92.74                        | 92.73                        | 98.72                       | 2                      | 6                      | 100             | 60              |
| 21''  | 83.88                         | 68.36                        | 101.85                       | 108.39                      | 3                      | 6                      | 0               | 9.09            |
| 22    | 105.71                        | 120.77                       | 110.75                       | 125.80                      | 0                      | 2                      | 100             | 91.67           |
| 23'   | 93.60                         | 81.87                        | 98.55                        | 97.36                       | 2                      | 0                      | 100             | 100             |
| 24    | 97.72                         | 86.75                        | 100.23                       | 101.96                      | 2                      | 6                      | 100             | 100             |
| 25'   | 104.47                        | 109.26                       | 104.45                       | 107.19                      | 6                      | 5                      | 100             | 66.67           |
| 26    | 100.93                        | 109.67                       | 97.60                        | 91.16                       | 5                      | 6                      | 100             | 91.67           |
| 27    | 112.22                        |                              |                              |                             | 3                      | 1                      | 50              | 87.50           |
| 28'   | 102.39                        | 101.43                       | 99.31                        | 98.93                       | 6                      | 6                      | 75.             | 72.73           |
| 29'   | 95.96                         | 88.61                        | 108.63                       | 112.69                      | 0                      | 3                      | 33.33           | 90.91           |
| 30    | 101.16                        | 101.90                       | 103.39                       | 105.77                      | 3                      | 4                      | 75              | 91.67           |
| 31''  | 94.75                         | 94.75                        | 89.25                        | 93.86                       | 3                      | 4                      | 25              | 63.64           |
| 32''  | 97.59                         |                              |                              |                             |                        |                        |                 |                 |
| 33''' | 89.43                         | 85.23                        | 76.00                        | 62.67                       | 0                      | -1                     | 0               | 0               |
| 34    | 93.11                         | 86.50                        | 96.81                        | 98.44                       | 7                      | 4                      | 87.50           | 91.67           |
| 35    | 85.06                         | 84.73                        | 104.30                       | 106.80                      | 5                      | 5                      | 83.33           | 83.33           |
| 36    | 92.71                         |                              |                              |                             | 1                      | 5                      | 50              | 88.89           |
| 37    |                               |                              |                              |                             |                        |                        |                 |                 |
| 38    | 93.31                         |                              |                              |                             | 3                      | 5                      | 87.50           | 81.82           |
| 39''' | 75.32                         | 70.77                        | 83.18                        | 78.64                       | 0                      | 1                      | 0               | 0               |
| 40    |                               |                              |                              |                             |                        |                        |                 |                 |
| 41    |                               |                              |                              |                             |                        |                        |                 |                 |
| 42'   | 106.51                        | 109.05                       | 100.78                       | 111.15                      | 2                      | 3                      | 100             | 100             |
| 43'   | 97.34                         | 96.47                        | 108.39                       | 112.16                      | 6                      | 6                      | 87.50           | 83.33           |
| 44    | 100.65                        | 101.00                       | 106.16                       | 105.17                      | 4                      | 4                      | 100             | 60              |
| 45''  | 98.90                         | 97.94                        | 98.82                        | 98.82                       | 8                      | 2                      | 87.50           | 60              |
| 46    | 94.69                         | 93.56                        | 108.04                       | 110.15                      | 5                      | 6                      | 100             | 66.67           |
| 47    | 104.61                        | 105.53                       | 97.10                        | 99.33                       | 2                      | 7                      | 66.67           | 63.64           |
| 48''' | 97.55                         | 95.35                        | 104.44                       | 104.69                      | 0                      | 4                      | 0               | 0               |
| 49''  | 102.40                        | 99.51                        | 98.80                        | 108.14                      | 4                      | 9                      | 83.33           | 60              |
| 50    | 91.45                         | 82.38                        | 99.52                        | 97.60                       | 5                      | 2                      | 83.33           | 100             |
| 51    | 72.63                         | 59.26                        | 95.99                        | 95.99                       | 2                      | 2                      | 50              | 28.57           |
| 52'   | 97.29                         | 86.25                        | 100.08                       | 98.00                       | 5                      | 5                      | 100             | 100             |
| 53''' | 79.38                         | 65.94                        | 75.68                        | 70.24                       | 0                      | 0                      | 0               | 0               |

|      |        |        |        |        |   |    |       |       |
|------|--------|--------|--------|--------|---|----|-------|-------|
| 54   | 80.33  | 67.96  | 96.14  | 86.13  | 3 | 3  | 66.67 | 80    |
| 55   | 72.60  | 54.95  | 101.18 | 97.54  | 6 | 8  | 83.33 | 62.50 |
| 56   | 98.55  | 97.47  | 100.59 | 105.15 | 1 | 4  | 100   | 66.67 |
| 57`  | 98.13  | 99.85  | 79.35  | 78.66  | 7 | 7  | 71.43 | 83.33 |
| 58   | 102.94 | 100.72 | 95.86  | 91.53  | 2 | 3  | 33.33 | 88.89 |
| 59`  | 109.25 | 99.32  | 115.43 | 130.50 | 7 | 3  | 87.50 | 91.67 |
| 60   | 124.39 | 154.01 | 111.71 | 141.61 | 3 | 5  | 100   | 90.91 |
| 61`  | 93.07  | 81.28  | 94.87  | 92.08  | 3 | 1  | 100   | 100   |
| 62   | 105.73 | 103.56 | 89.33  | 83.91  | 5 | 8  | 100   | 66.67 |
| 63`  | 104.56 | 105.34 | 96.19  | 94.37  | 3 | 4  | 60    | 33.33 |
| 64`  | 92.56  | 93.26  | 96.84  | 95.99  | 2 | 3  | 0     | 0     |
| 65`  | 103.33 | 113.96 | 96.86  | 103.65 | 5 | 7  | 87.50 | 83.33 |
| 66`  | 96.21  | 96.31  | 83.67  | 82.72  | 4 | 3  | 100   | 0     |
| 67`  | 85.75  | 82.11  | 97.89  | 101.25 | 1 | 4  | 50    | 0     |
| 68`  | 96.61  | 91.49  | 101.93 | 101.93 | 6 | 1  | 100   | 100   |
| 69   | 87.83  | 86.46  | 83.83  | 83.41  | 0 | 4  | 0     | 0     |
| 70`  | 97.65  | 96.25  | 81.16  | 80.84  | 0 | 1  | 100   | 0     |
| 71`  | 89.78  | 83.57  | 100.66 | 95.86  | 5 | 8  | 100   | 83.33 |
| 72   | 98.04  | 101.97 | 99.42  | 101.68 | 6 | 5  | 87.50 | 50    |
| 73   | 79.93  | 68.74  | 98.83  | 100.11 | 5 | 7  | 100   | 66.67 |
| 74`  | 90.04  | 84.64  | 84.31  | 85.37  | 0 | 0  | 0     | 0     |
| 75   | 89.33  | 81.16  | 107.05 | 104.66 | 2 | 5  | 100   | 58.33 |
| 76   | 108.11 | 108.24 | 110.13 | 130.39 | 3 | 4  | 100   | 100   |
| 77   | 92.01  | 91.19  | 89.56  | 90.21  | 5 | 7  | 40    | 12.50 |
| 78   | 89.33  | 80.36  | 99.07  | 101.24 | 4 | 6  | 100   | 100   |
| 79   | 79.90  | 76.33  | 105.34 | 104.65 | 6 | 5  | 71.43 | 63.64 |
| 80   | 97.94  | 90.65  | 95.91  | 88.58  | 4 | 5  | 100   | 100   |
| 81   | 92.51  | 83.38  | 95.99  | 97.55  | 3 | 7  | 87.50 | 83.33 |
| 82   | 79.10  | 79.81  | 104.13 | 102.94 | 3 | 6  | 80    | 90    |
| 83   | 96.62  | 92.85  | 107.37 | 112.71 | 5 | 7  | 57.14 | 66.67 |
| 84   | 101.00 | 102.05 | 90.24  | 90.05  | 1 | 3  | 100   | 50    |
| 85   | 105.14 | 99.76  | 95.25  | 96.43  | 5 | 6  | 50    | 50    |
| 86   | 99.78  | 97.22  | 93.79  | 90.89  | 2 | 5  | 100   | 91.67 |
| 87`  | 89.23  | 88.10  | 98.49  | 99.87  | 2 | 6  | 100   | 90.91 |
| 88`  | 86.39  | 78.27  | 101.15 | 97.33  | 7 | 3  | 100   | 91.67 |
| 89`  | 102.77 | 106.41 | 95.24  | 100.73 | 3 | 5  | 100   | 83.33 |
| 90   | 96.31  | 88.75  | 103.83 | 101.17 | 3 | 7  | 60    | 91.67 |
| 91   | 99.61  | 90.00  | 99.38  | 96.00  | 5 | 3  | 75    | 100   |
| 92`  | 88.13  | 70.35  | 91.21  | 80.74  | 0 | 2  | 0     | 0     |
| 93   | 89.40  | 93.82  | 75.81  | 77.38  | 0 | -1 | 0     | 0     |
| 94   | 95.15  | 96.52  | 105.78 | 123.78 | 7 | 4  | 100   | 100   |
| 95`  | 95.13  | 90.67  | 102.76 | 108.77 | 1 | 3  | 75    | 28.57 |
| 96   | 101.32 | 96.65  | 92.63  | 87.81  | 3 | 3  | 66.67 | 66.67 |
| 97`  | 88.03  | 83.75  | 101.97 | 100.96 | 4 | 5  | 87.50 | 75    |
| 98   | 53.41  | 45.12  | 62.84  | 54.71  | 2 | 3  | 0     | 0     |
| 99   | 86.55  | 83.42  | 97.33  | 96.55  | 4 | 5  | 80    | 60    |
| 100  | 88.34  | 79.88  | 96.73  | 98.18  | 5 | 6  | 85.71 | 83.33 |
| 101  | 89.43  | 86.03  | 92.81  | 89.68  | 3 | 8  | 50    | 75    |
| 102  | 95.75  | 90.48  | 99.99  | 101.12 | 4 | 5  | 75    | 100   |
| 103  | 99.50  | 93.04  | 88.15  | 78.94  | 8 | 1  | 100   | 100   |
| 104  | 90.99  | 78.51  | 100.48 | 90.35  | 6 | 6  | 100   | 91.67 |
| 105` | 96.40  | 95.77  | 90.58  | 93.72  | 1 | 7  | 100   | 41.67 |
| 106` | 92.88  | 87.47  | 89.60  | 80.43  | 7 | 8  | 62.50 | 36.36 |
| 107` | 92.00  | 89.20  | 99.92  | 99.48  | 8 | 3  | 87.50 | 100   |
| 108  | 90.47  | 81.66  | 96.13  | 90.69  | 5 | 6  | 100   | 83.33 |
| 109` | 96.00  | 96.00  | 92.51  | 92.51  | 3 | 3  | 75    | 83.33 |
| 110` | 86.02  | 80.16  | 99.43  | 108.99 | 3 | 5  | 100   | 83.33 |
| 111  | 108.89 | 108.45 | 102.32 | 99.66  | 2 | 7  | 50    | 91.67 |

|         |        |        |        |        |   |    |       |       |
|---------|--------|--------|--------|--------|---|----|-------|-------|
| 112     | 108.74 | 105.99 | 102.93 | 106.48 | 8 | 8  | 100   | 58.33 |
| 113     | 99.17  | 97.98  | 95.25  | 99.57  | 0 | 5  | 0     | 75    |
| 114     | 95.65  | 94.38  | 91.74  | 90.37  | 5 | 2  | 50    | 87.50 |
| 115``   | 80.43  | 65.89  | 101.94 | 94.20  | 1 | 4  | 50    | 55.56 |
| 116     | 92.17  | 81.03  | 86.42  | 72.82  | 0 | 5  | 100   | 91.67 |
| 117`    | 100.42 | 95.40  | 95.64  | 92.62  | 0 | 4  | 85.71 | 45.45 |
| 118`    | 90.41  | 75.32  | 72.91  | 60.77  | 5 | 3  | 80    | 100   |
| 119     | 85.29  | 73.56  | 92.07  | 87.91  | 3 | 7  | 100   | 100   |
| 120``   | 97.46  | 93.00  | 104.39 | 97.37  | 3 | 7  | 100   | 45.45 |
| 121     | 97.85  | 97.54  | 101.79 | 104.05 | 1 | 2  | 100   | 100   |
| 122     | 95.88  | 91.72  | 103.55 | 102.60 | 0 | 8  | 0     | 60    |
| 123     | 115.43 | 116.49 | 88.79  | 85.43  | 5 | 6  | 80    | 100   |
| 124     | 104.07 | 106.64 | 111.64 | 112.33 | 4 | 5  | 100   | 83.33 |
| 125     | 104.89 | 106.61 | 98.47  | 96.03  | 3 | 4  | 100   | 77.78 |
| 126     | 80.71  | 75.93  | 58.06  | 33.75  | 0 | -1 | 0     | 0     |
| 127     | 86.02  | 82.60  | 84.60  | 77.19  | 6 | 5  | 100   | 75    |
| 128     | 91.93  | 87.15  | 101.82 | 101.88 | 4 | 4  | 100   | 100   |
| 129``   | 85.94  | 79.91  | 94.89  | 93.70  | 4 | 5  | 100   | 100   |
| 130     | 96.56  | 96.01  | 102.91 | 99.13  | 3 | 5  | 66.67 | 55.56 |
| 131`    | 112.49 | 98.30  | 104.83 | 108.19 | 1 | 3  | 100   | 66.67 |
| 132``   | 102.63 | 102.63 | 95.22  | 95.22  | 2 | 4  | 33.33 | 0     |
| 133     | 98.17  | 90.31  | 105.58 | 104.70 | 7 | 3  | 85.71 | 70    |
| 134``   | 95.30  | 95.88  | 97.44  | 100.53 | 3 | 7  | 80    | 83.33 |
| 135     | 91.22  | 84.93  | 104.32 | 109.06 | 4 | 7  | 50    | 66.67 |
| 136``   | 95.58  | 96.11  | 78.69  | 79.75  | 2 | 5  | 75    | 0     |
| 137     | 100.47 | 97.20  | 92.14  | 87.81  | 0 | 4  | 0     | 0     |
| 138```` | 78.74  | 76.58  | 87.89  | 90.13  | 0 | 4  | 0     | 50    |
| 139`    | 102.19 | 106.06 | 99.47  | 97.19  | 3 | 5  | 100   | 100   |
| 140     | 83.20  | 82.12  | 84.60  | 85.27  | 0 | 2  | 100   | 33.33 |
| 141     | 78.00  | 78.26  | 87.37  | 89.96  | 2 | 5  | 87.50 | 58.5  |
| 142``   | 93.32  | 100.45 | 97.62  | 95.75  | 0 | 2  | 0     | 57.14 |
| 143     | 105.39 | 109.30 | 94.69  | 93.48  | 7 | 4  | 100   | 100   |
| 144     | 97.50  | 96.97  | 92.73  | 90.61  | 1 | 6  | 100   | 33.33 |
| 145     | 94.63  | 93.68  | 105.93 | 111.90 | 3 | 6  | 100   | 100   |
| 146     | 107.53 | 113.82 | 113.24 | 115.00 | 1 | 4  | 100   | 75    |
| 147```` | 82.63  | 79.68  | 75.32  | 70.48  | 0 | 4  | 0     | 0     |
| 148```` | 99.91  | 95.83  | 89.34  | 86.22  | 1 | 2  | 0     | 20    |